

24-Port CAT 6A FTP Blank Patch Panel w/24 Unloaded CAT 6A Inserts

PRODUCT SPECIFICATION

Package includes:

- A. 24-Port CAT 6A FTP Blank Patch Panel, 1 pc
- B. CAT 6A, FTP, Modular Insert, 24 pcs
- C. Cable Tie, 24 pcs
- D. #12-24 x 5/8" Pan Head,
Pilot Point Machine Screw, 4 pcs
- E. Cable Management Bar, 1 pc

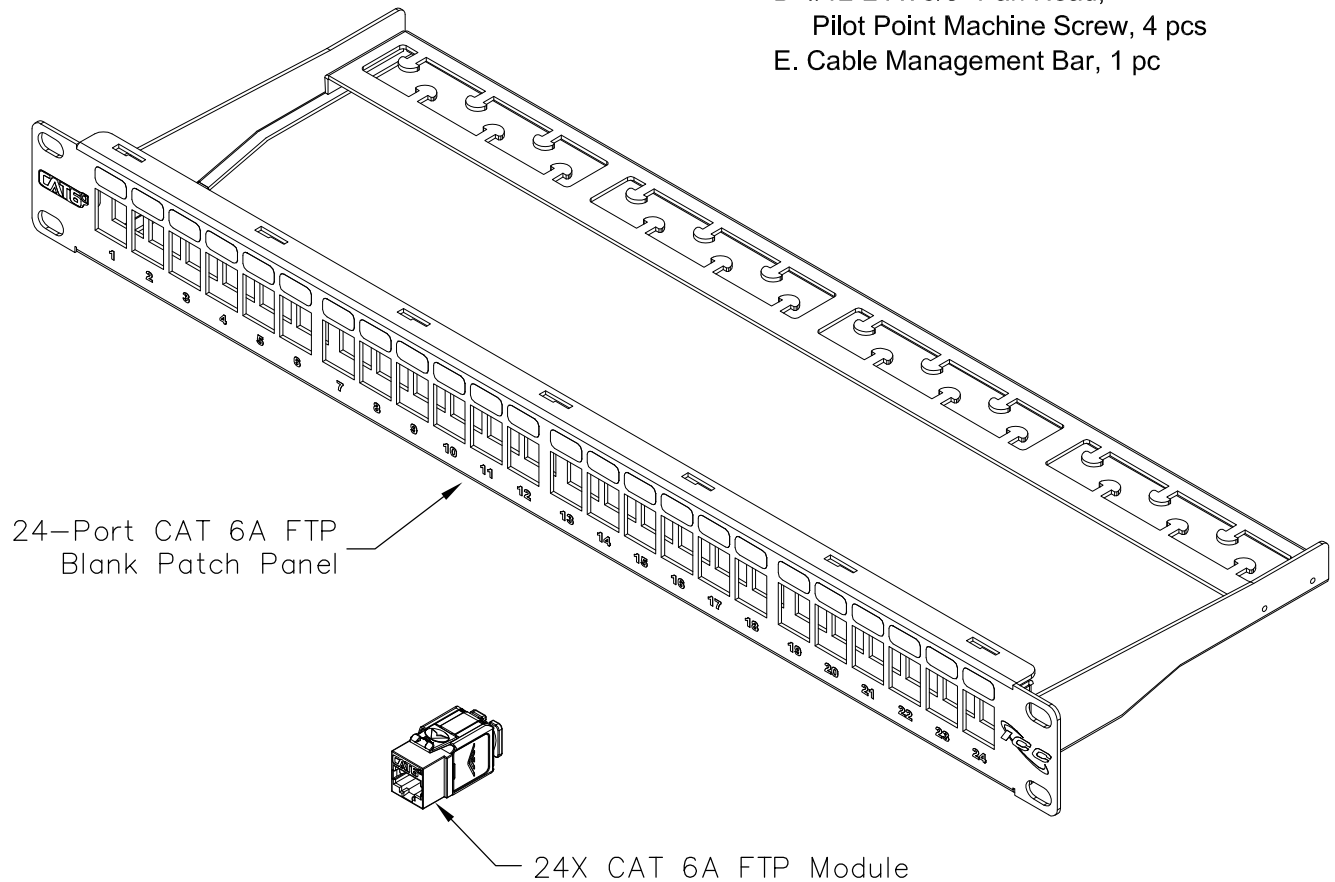

Features and Benefits:

- Accommodates ICC CAT6A FTP Modular Connector
- Designed to minimize the alien crosstalk for 10G applications
- Includes rear cable management to facilitate proper bend radius of cable
- Compatible with standard 19" distribution racks
- Pre-installed grounding studs for quick installation

PATCH PANEL, CAT 6A, SHIELDED, 24-P, 1RMS

ITEM NO.	ICMPP246AS
DWG NO.	PSMPP246AS

REV.	A
PAGE NO.	1



CUSTOMER CARE / TECHNICAL SUPPORT * CSR@ICC.COM / 888-ASK-4-ICC (275-4422) * 14700 Alondra Blvd, La Mirada, CA 90638 * Phone 562-356-3111 * Fax 562-356-3100 * www.icc.com

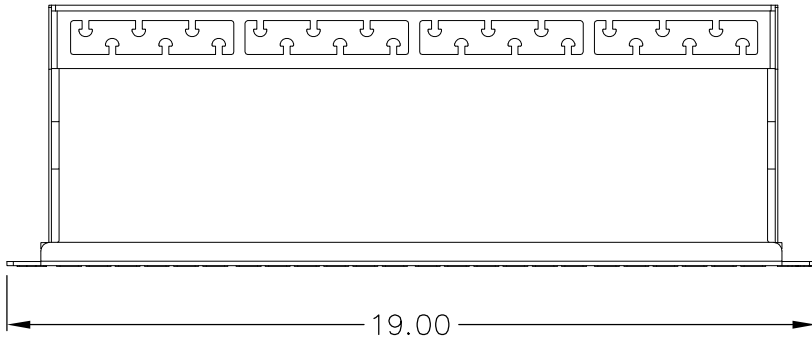

NOTE: UNLESS OTHERWISE SPECIFIED
 1. 24-PORT PATCH PANEL:
 A. MATERIAL: 16GA CRS
 B. SURFACE FINISH: FRONT - BLACK POWDER COAT
 BACK - ZINC PLATED

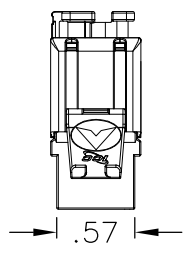
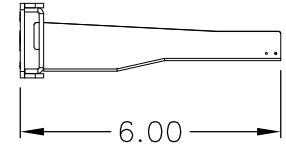
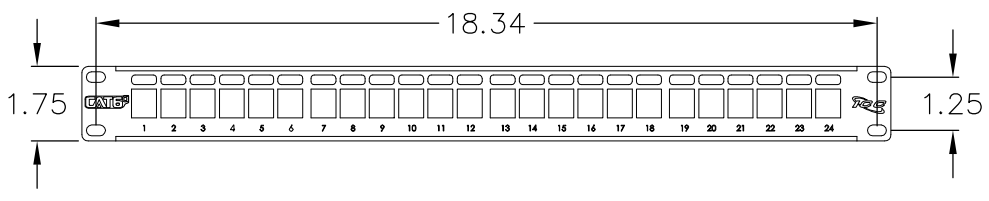

NOTE: UNLESS OTHERWISE SPECIFIED
 1. CAT6A FTP MODULAR CONNECTOR:
 A. ENVIRONMENTAL CONDITIONS:
 -TEMPERATURE RANGE
 -STORAGE:-40 TO +70°C, OPERATIONAL:-10 TO +60°C
 -RELATIVE HUMIDITY (OPERATIONAL):
 MAXIMUM NONCONDENSING 93%
 B. ELECTRICAL:
 -INSULATION RESISTANCE: 500 MEGAOHM MIN
 -CONTACT RESISTANCE: 20 MILLIOHM MAX
 -DIELECTRIC WITHSTANDING VOLTAGE: 1,000 VOLTS D.C.,
 60 HZ, 1 MIN
 C. MECHANICAL:
 -TOTAL CONTACT FORCE: 800 GRAM FOR
 8 WIRE LEADS MINIMUM
 -RETENTION: 50N (11 LBF) FOR 60S±5S
 -INSERTION LIFE: 750 CYCLES MIN
 D. PHYSICAL:
 -HOUSING: ZINC-ALLOY FULLY SHIELDED
 -SPRING WIRE: PHOSPHOR BRONZE ALLOY
 PLATED WITH 50 MICRO-INCH OF GOLD OVER
 70~100 MICRO-INCH OF NICKEL
 2. WIRE TERMINATION CAP: ABS
 3. IDC WIRE GAUGE: 22~24 AWG
 4. CERTIFICATION:
 A. MEETS ANSI/TIA-568-C.2 (500 MHz)

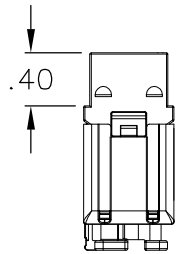
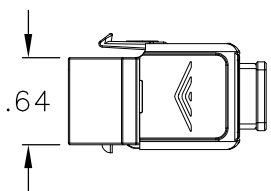
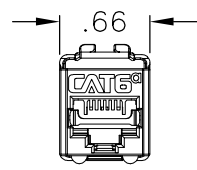
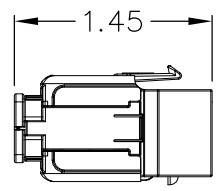

PATCH PANEL, CAT 6A, SHIELDED, 24-P, 1 RMS		 Premium Products Proven Performance Competitive Prices
ITEM NO.	ICMPP246AS	
DWG NO.	PSMPP246AS	PAGE NO. 2

CUSTOMER CARE / TECHNICAL SUPPORT * CSR@ICC.COM / 888-ASK-4-ICC (275-4422) * 14700 Alondra Blvd, La Mirada, CA 90638 * Phone 562-356-3111 * Fax 562-356-3100 * www.icc.com