

Digital Control Active Line Array

APPLICATIONS

- Live sound
- Corporate events
- Theatres
- A/V presentations

MAIN FEATURES

DLA 804A:

- Active line array with digital aiming
- 8 x 4" full range custom spkrs
- 8 x 50W RMS Class D amplifiers
- 120Hz - 20kHz frequency response
- Extruded aluminum cabinet

DLA 1244A:

- Active line array with digital aiming
- 12 x 4" full range custom spkrs
- 4 x 1" neodymium dome tweeters
- 16 x 50W RMS Class D amplifiers
- 100Hz - 20kHz frequency response
- Extruded aluminum cabinet

PRODUCT DESCRIPTION

Built in elegant aluminum scratch resistant cabinet, DLA is an active steerable array system that provides exceptional intelligibility in highly reverberant environments. The characteristics of the lobe radiation directional controls, the high SPL, the HI-FI frequency range, the elegance and overall dimensions, make the DLA system particularly suitable for high quality sound even in acoustically difficult environments, given the capacity of the wavefront to soften of about 3dB upon doubling the distance from the source. The DLA 1244A with a 100Hz to 20kHz frequency response, is recommended for voice and high-quality music reproduction; it can be used in association with DLA 804A in order to create a full-range system. Both DLA models have a dedicated SUB output to extend performance at low frequencies. The DLA system features a RS-485 network connection for total control through PC. Wall mount installation with the supplied bars.

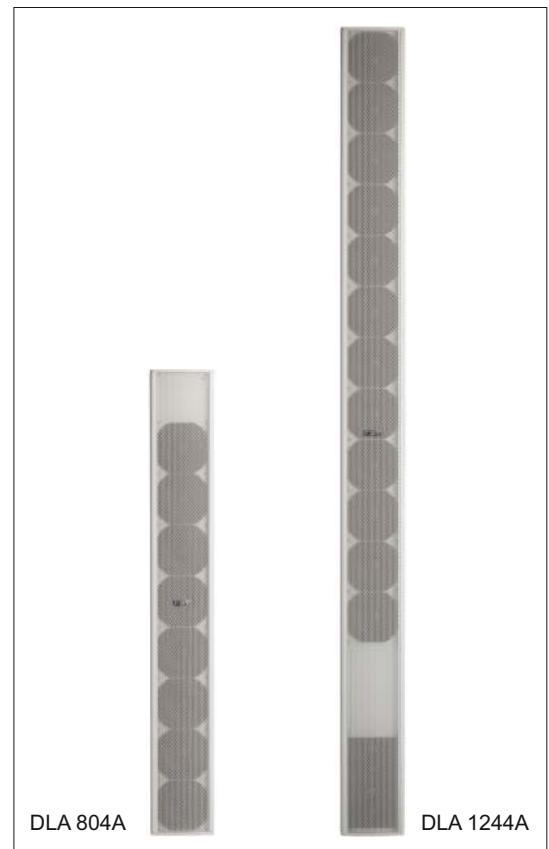

ELECTRICAL PERFORMANCE

	DLA 804A	DLA 1244A
System Type	8 way	16 way
Built-in Amplifiers	cont.: 8 x 40W max.: 8 x 50W peak.: 8 x 100W	cont.: 16 x 40W max.: 16 x 50W peak.: 16 x 100W
Frequency Response @ -6dB	120Hz - 20kHz	100Hz - 20kHz
Input Impedance	22kOhm	22kOhm
Maximum SPL (cont. / peak)	120dB / 123dB	123dB / 126dB
Dispersion	100° digital controlled	100° digital controlled
Crossover Frequency	3 kHz	1.8 kHz
AC Power requirement	400 VA	650 VA

PHYSICAL

	DLA 804A	DLA 1244A
Low Frequency Woofer	8 x 4" / 1" coil	12 x 4" / 1" coil
High Frequency Driver	-----	4 x 1" / 1" coil
Input Connectors	Euroblock	Euroblock
Net Dimensions (WxHxD)	5,11" x 38" x 5,15" 130 x 965 x 131mm	5,11" x 66,33" x 5,15" 130 x 1685 x 131mm
Shipping Dimensions (WxHxD)	8,66" x 40,94" x 8,66" 220 x 1040 x 220mm	8,66" x 69,29" x 8,66" 220 x 1760 x 220mm
Net Weight	26,66 lbs / 13 kg	48,50 lbs / 22 kg
Shipping Weight	31,96 lbs / 14,5 kg	54,01 lbs / 24,5 kg
Enclosure Material	extruded aluminium	extruded aluminium
Power cord	16.4 ft / 5 mt.	16.4 ft / 5 mt.

DIAGRAMS

HORIZONTAL POLAR DIAGRAM

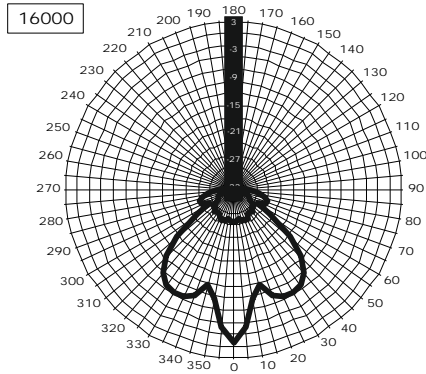
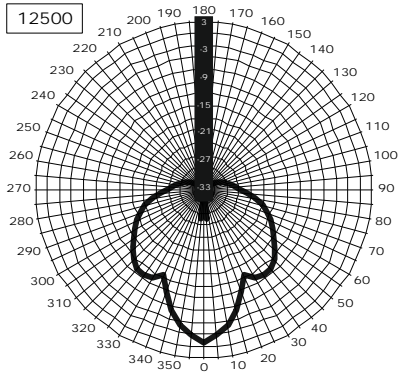
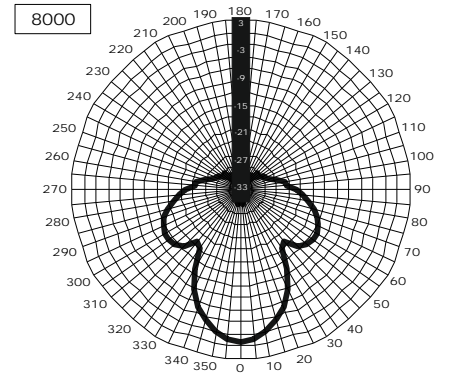
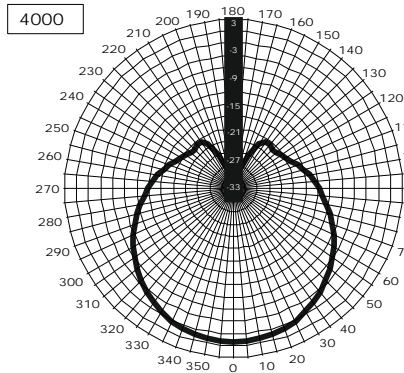
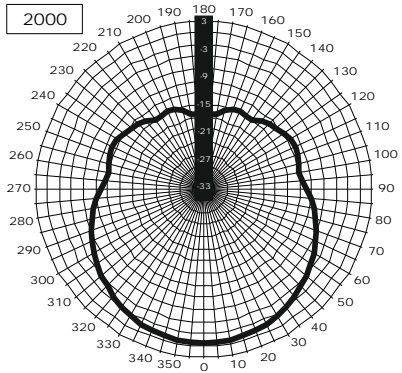
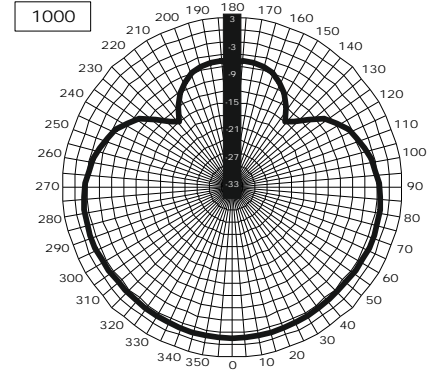
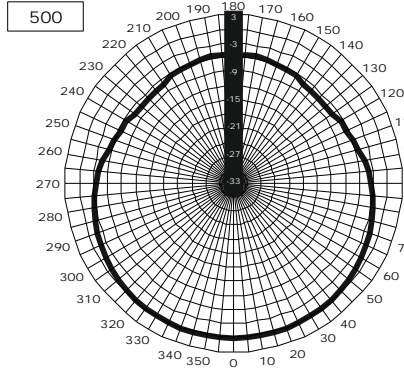
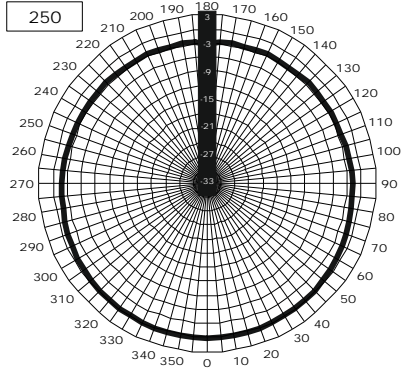

DIAGRAMS

HORIZONTAL POLAR DIAGRAM

