

LINE
ARRAY
SYSTEMS

DLA 804A - Digital Control Active Line Array
DLA 1244A - Digital Control Active Line Array

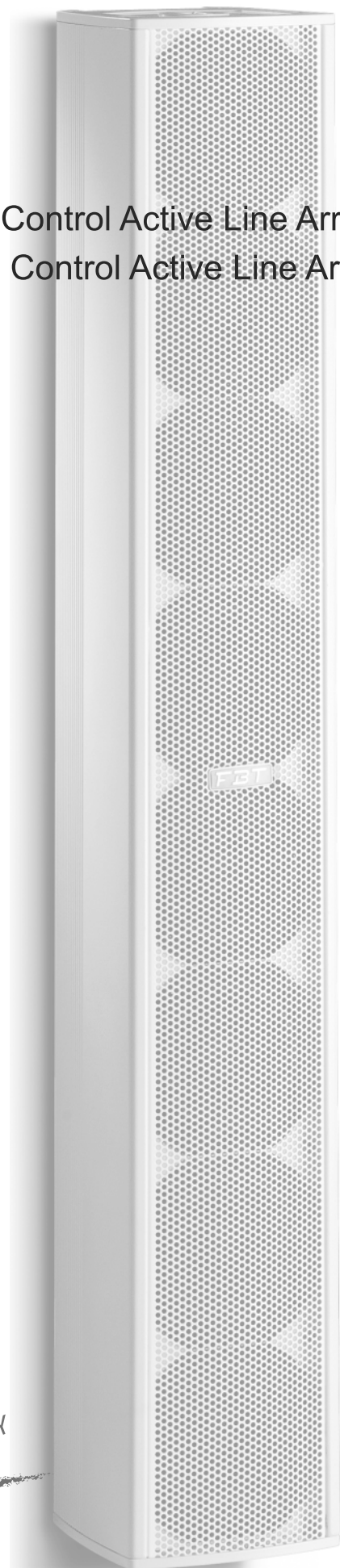

*Designed, Engineered
and Manufactured in ITALY*

FBT elettronica SpA -

Via Paolo Soprani 1 - 62019 RECANATI - ITALY

Tel. 071 750591 - Fax. 071 7505920 - email: info@fbt.it - www.fbt.it

FBT

VECTO

ENGLISH

INDEX

<i>WARNING - IMPORTANT SAFETY INSTRUCTIONS - PRECAUTIONS</i>	1
<i>INTRODUCTION</i>	2
<i>GENERAL FEATURES</i>	3/4
<i>CONNECTORS</i>	5
<i>DIMENSIONS</i>	6/7
<i>INSTALLATION MODE</i>	8/9
<i>CONTROLS AND FUNCTIONS</i>	10/11
<i>CONNECTION OF LOUDSPEAKERS</i>	12
<i>USB-RS485 CONVERTER</i>	12
<i>CONNECTION EXAMPLES</i>	13
<i>TECHNICAL SPECIFICATIONS</i>	14



WARNING
RISK OF ELECTRIC SHOCK
DO NOT OPEN



**TO REDUCE THE RISK OF ELECTRIC SHOCK
DO NOT REMOVE COVER (OR BACK)
NO USER SERVICEABLE PARTS INSIDE
REFER SERVICING TO QUALIFIED SERVICE PERSONNEL**

**TO REDUCE THE RISK OF FIRE OR ELECTRIC SHOCK
DO NOT EXPOSE THIS EQUIPMENT TO RAIN OR MOISTURE**



WHERE MARKED, THIS SYMBOL INDICATES A DANGEROUS NON-ISOLATED VOLTAGE INSIDE THE LOUDSPEAKER. SUCH VOLTAGE COULD BE SUFFICIENT TO RESULT IN THE RISK OF ELECTRIC SHOCK.



WHERE MARKED, THIS SYMBOL INDICATES IMPORTANT USAGE AND MAINTENANCE INSTRUCTIONS IN THE ENCLOSED DOCUMENTS. PLEASE REFER TO THE MANUAL.

IMPORTANT SAFETY INSTRUCTIONS

- 1) Read these instructions
- 2) Keep these instructions
- 3) Heed all warnings
- 4) Follow all instructions
- 5) Do not use this apparatus near water
- 6) Clean only with dry cloth
- 7) Do not block any ventilation openings. Install in accordance with the manufacturer's instructions.
- 8) Do not install near any heat sources, such as radiators, heat registers, stoves or other apparatus (including amplifiers) that produce heat
- 9) Do not defeat the safety purpose of the polarized or grounding-type plug. A polarized plug has two blades with one wider than the other. A grounding type plug has two blades and a third grounding prong. The wide blade or the third prong are provided for your safety. If the provided plug does not fit into your outlet, consult an electrician for replacement of the obsolete outlet.
- 10) Protect the power cord from being walked on or pinched particularly at plugs, convenience receptacles, and the point where they exit from the apparatus.
- 11) Only use attachments/accessories specified by the manufacturer.
- 12) Use only with the cart, stand, tripod, bracket, or table specified by the manufacturer or sold with the apparatus. When a cart is used, use caution when moving the cart/apparatus combination to avoid injury from tip-over.
- 13) Unplug this apparatus during lightning storms or when unused for long periods of time.
- 14) Refer all servicing to qualified service personnel. Servicing is required when the apparatus has been damaged in any way, such as power-supply cord or plug is damaged, liquid has been spilled or objects have fallen into the apparatus, the apparatus has been exposed to rain or moisture, does not operate normally, or has been dropped.



THE DEVICE MUST BE CONNECTED TO THE MAINS THROUGH A POWER OUTLET WITH A PROTECTIVE EARTH CONNECTION.

This device features a power outlet ; install the device so that the outlet for the power cord is easily accessible .

PRECAUTIONS

- ° For proper air ventilation please make sure to leave sufficient clearance (min 11 inc.) on all sides of the device.
- ° Please do not cover the ventilation slots with papers, table cloths, curtains, etc. in order not to prevent ventilation of the device.
- ° Please do not place any naked flame source, such as lighted candles, on the device.
- ° Please keep the device away from water springs and splashes and please do not place any objects containing liquids, such as vases, on the device.

Two new models are going to enrich the **VERTUS** range: **DLA804A** and **DLA1244A**, array loudspeaker with digital aiming.

This system can be controlled manually, by adjusting individual loudspeakers using the relevant controls on the back, or remotely from a PC: thanks to the USB-RS485 converter and RJ45 jumper the **DLA** system can be connected to any PCs. The special control software will make it possible to accurately adjust all system's aiming and equalisation parameters, with the support of an environment for the simulation and overview of the sound field. Once the desired configuration is obtained, the data are transmitted to the **DLA** system.

These loudspeakers are made of elegant aluminium cabinets, covered in a scratch and scuff resistant black paint. They allow to solve several sound diffusion issues in difficult and reverberating environments.

Both models feature a dedicated Sub output on Euroblock connector for obtaining excellent performance also for low frequencies.

VERTUS DLA 804A

- > Active line array column with digital aiming
- > 8 x 4" full range custom speakers with 1" coil
- > Control panel with XLR input, HP filter, volume, preset, 7 different aiming angles, ground lift, RJ45 in/out for RS485 network, Euroblock connector for input and audio output.
- > 120Hz to 20kHz frequency response
- > 8 x 50W RMS Class D amplifiers for an overall power of 400W
- > Extruded aluminium cabinet with top and bottom mounting system
- > Full range control of directional pattern from +10° to -20° with sound beam width of 5° and 40°.
- > PC/S�AVE function for PC controlled directional pattern
- > Front state led
- > Wall installation by using the provided brackets
- > Perfect for high quality voice play in sound reverberating environments



VERTUS DLA 1244A

- > Active line array column with digital aiming
- > 12 x 4" full range custom speakers with 1" coil
- > 4 x 1" neodymium dome tweeter on waveguides
- > Control panel with XLR input, HP filter, volume, preset, 7 different aiming angles, ground lift, RJ45 in/out for RS485 network, Euroblock connector for input and audio output.
- > 100Hz to 20kHz frequency response
- > 16 x 50W RMS Class D amplifiers for an overall power of 800W
- > Extruded aluminium cabinet with top and bottom mounting system
- > Full range control of directional pattern from +10° to -20° with sound beam width of 5° and 40°.
- > PC/SLAVE function for PC controlled directional pattern
- > Front state led
- > Wall installation by using the provided brackets
- > Perfect for high quality voice play in sound reverberating environments



CONNECTORS

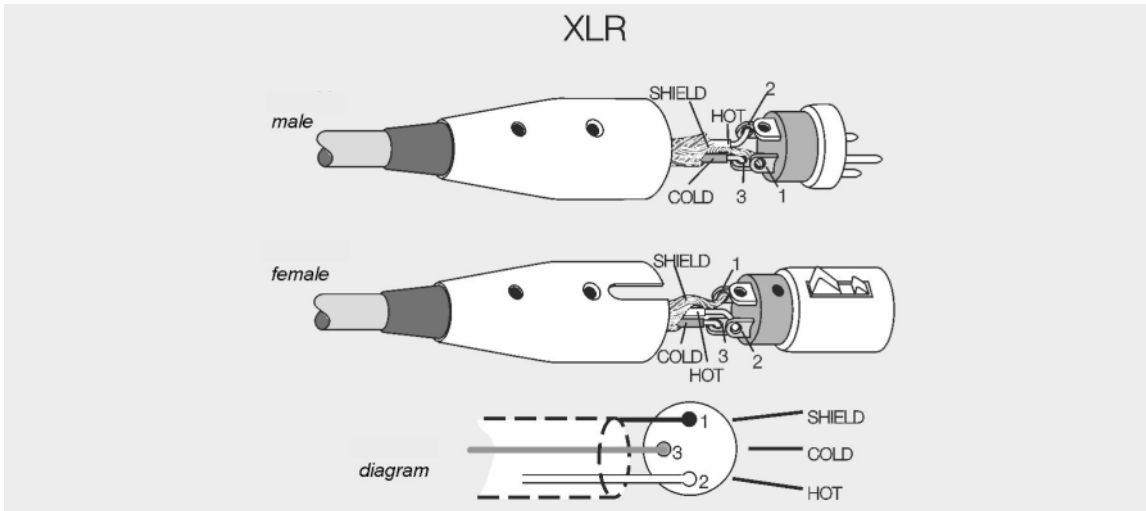

The 3-pole XLR connectors are almost always used for conducting mono-balanced signals; the three poles correspond respectively to ground (1), the positive signal (2) and the negative signal (3).

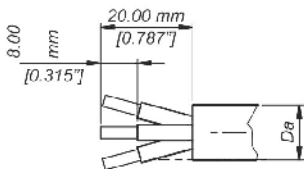

PowerCon Cable Preparation

white chuck $D_a = 5.00 [0.197"] - 11.00 [0.433"]$
 black chuck $D_a = 9.50 [0.374"] - 15.00 [0.59"]$

Wiring

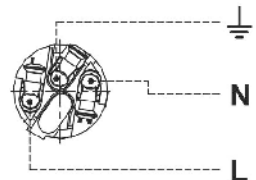

Assembling

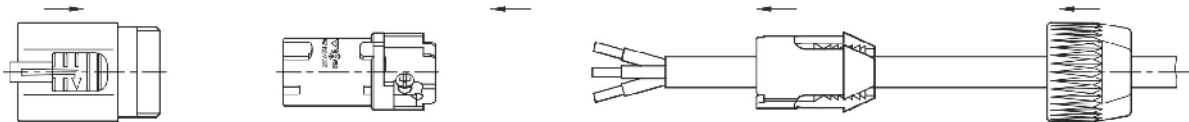

Wiring

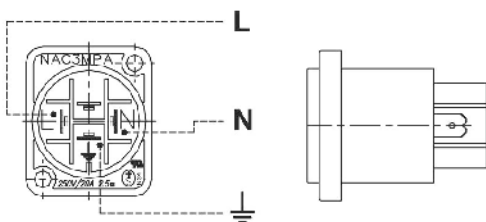

Panel Cutout (Rear Side)

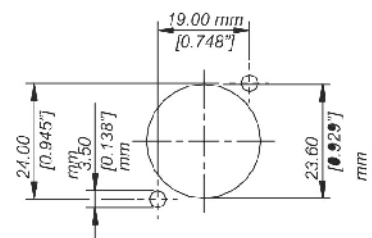

DIMENSIONS

DLA 804A

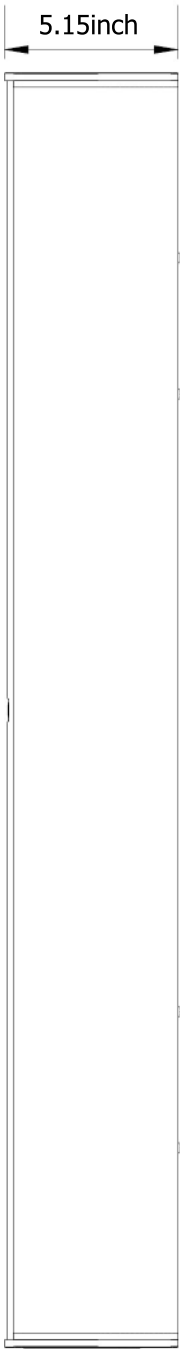
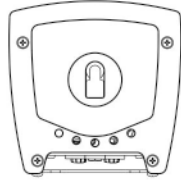

SIDE

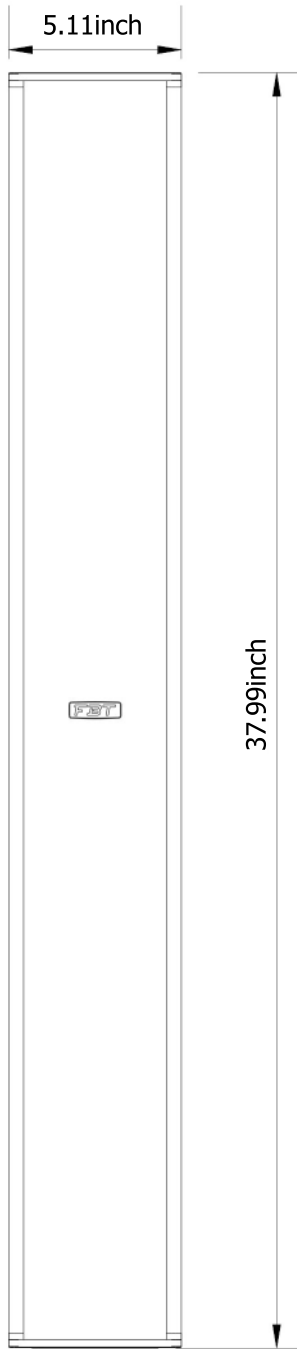

FRONT



SIDE

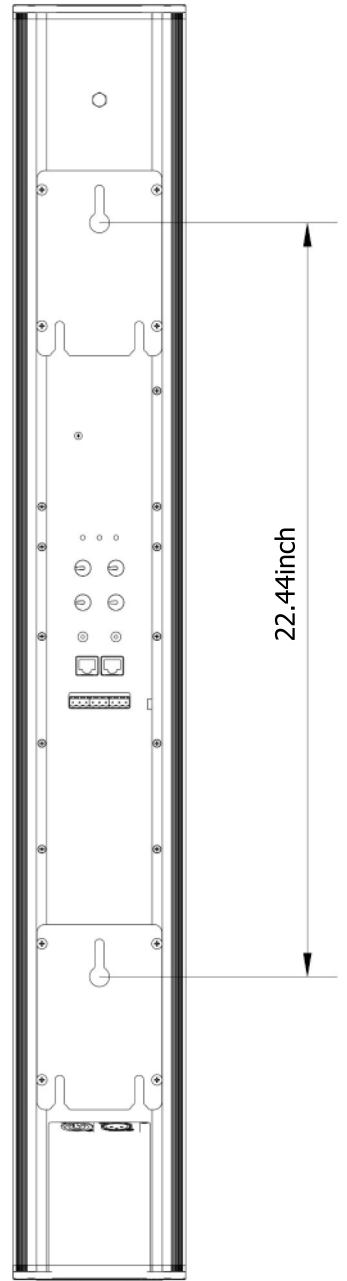

REAR

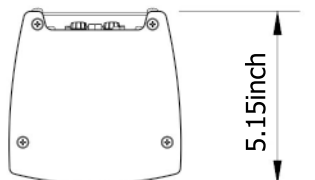

5.15inch

DIMENSIONS

DLA 1244A

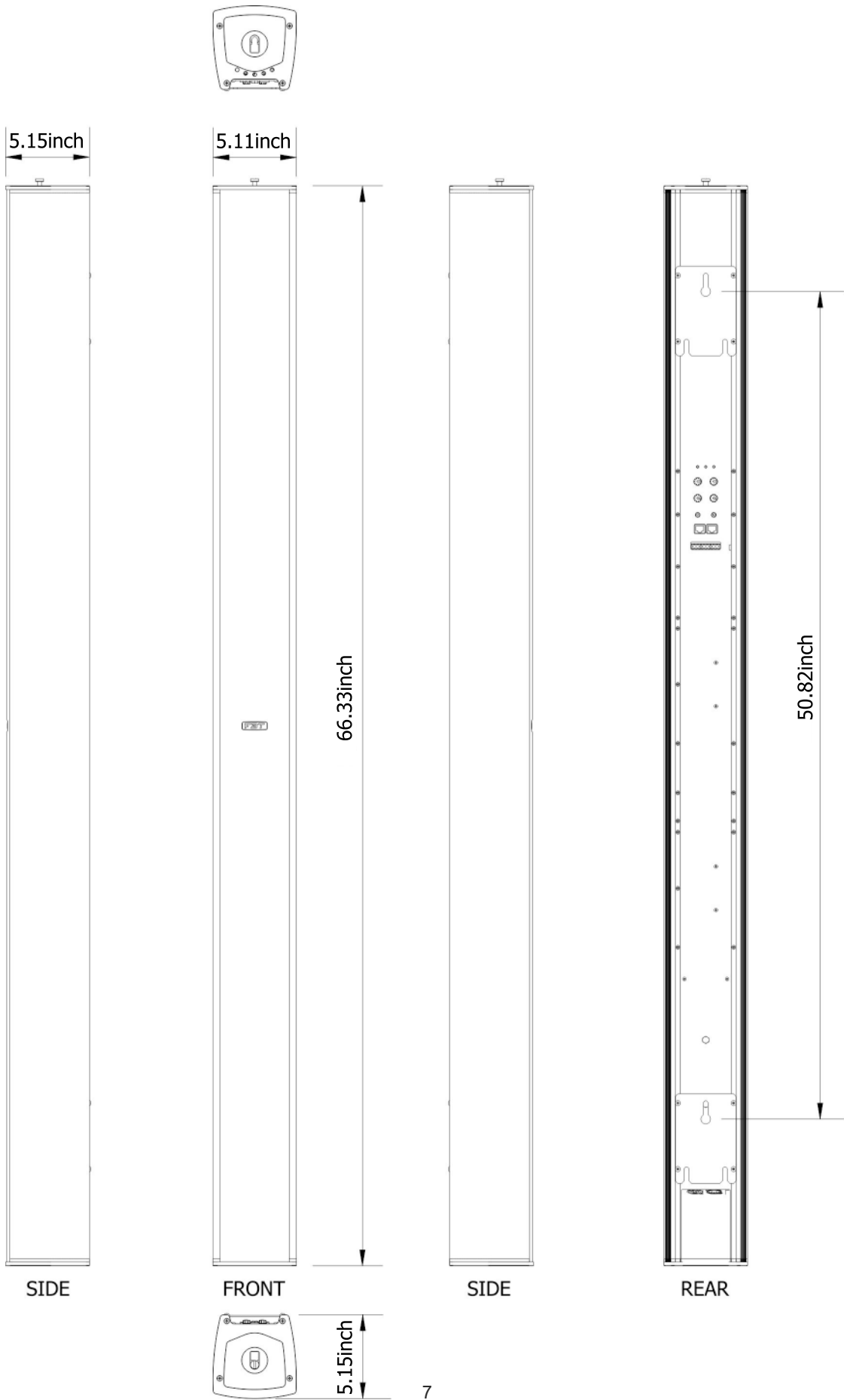

INSTALLATION MODE



The loudspeakers of the **VERTUS DLA** series must be installed by suspension using wall brackets.

Besides the main suspension system, all flying speakers in theatres, indoor stadiums or in several other work and/or leisure facilities shall be provided with an additional independent safety system with the adequate load capacity.

WARNING: carefully select the area where to install the speakers and make sure that the structure is adequate to support the weight of boxes. FBT will not be held responsible for any damage to persons or property in case of failure to comply with these instructions or failure to check the safety factor of all components involved in the installation system.

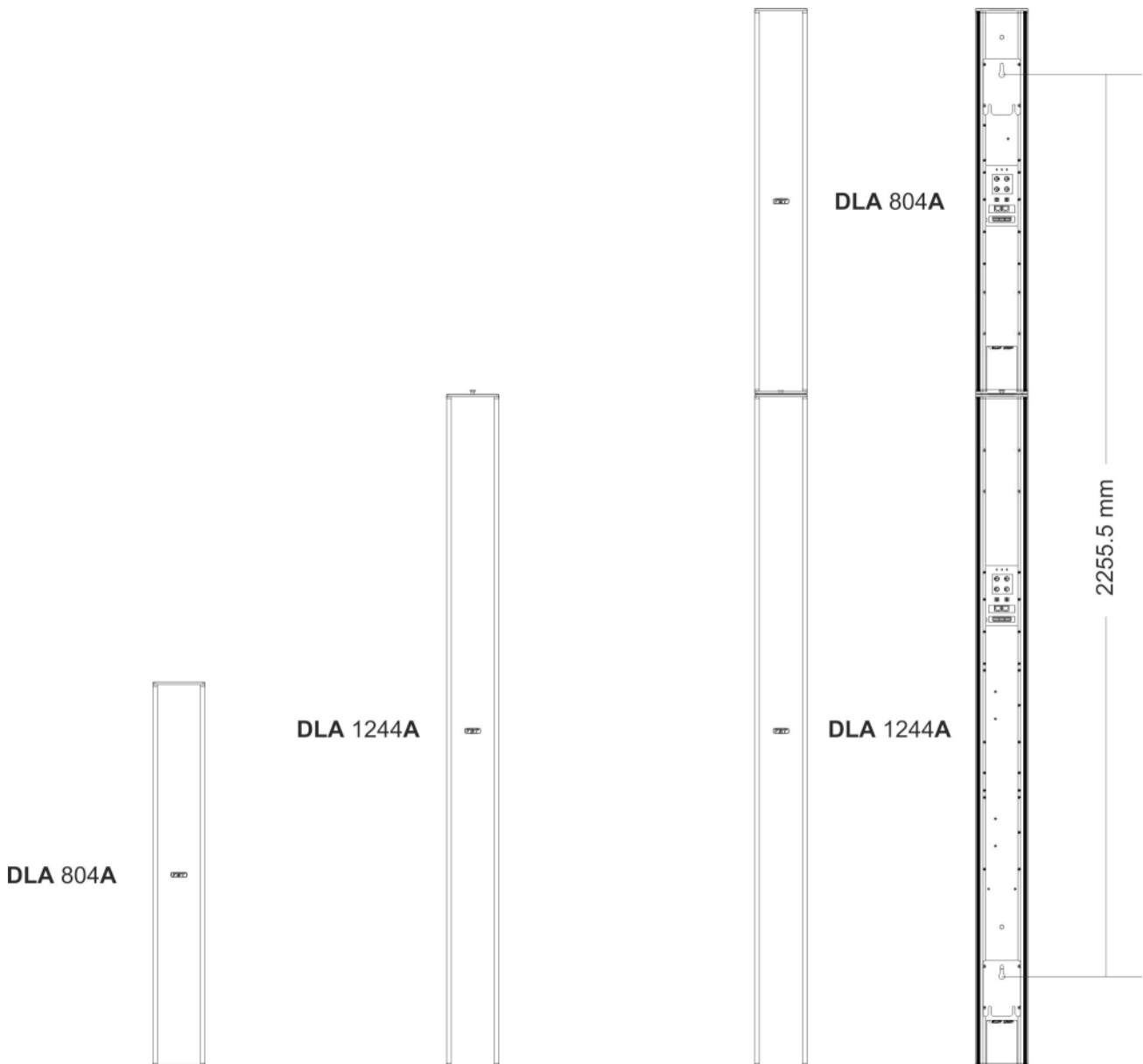

INSTALLATION MODE

CONNECTION OF TWO COLUMNS

Connect the two satellites to one another as shown in picture "A".

For wall mounting use adequate anchor slots (picture B).

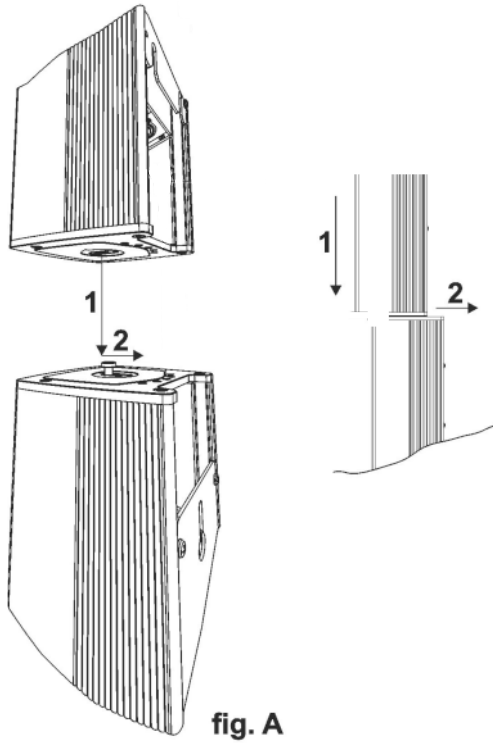
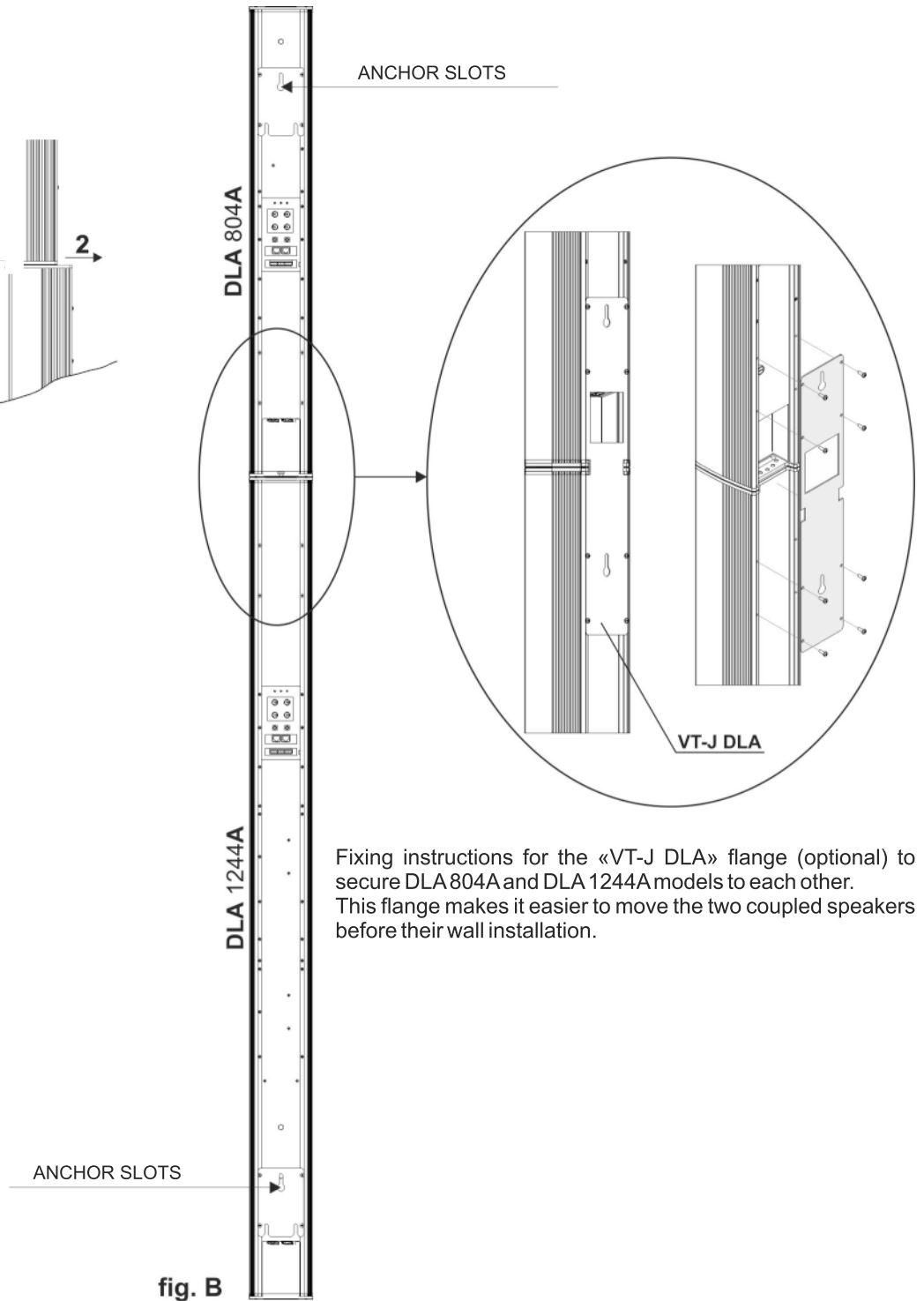

fig. A



Fixing instructions for the «VT-J DLA» flange (optional) to secure DLA 804A and DLA 1244A models to each other. This flange makes it easier to move the two coupled speakers before their wall installation.

fig. B

VERTUS
DLA 804A

ON: Indicates that the system is on.

PEAK/LIMIT: When the “peak” LED goes on, it indicates that the signal level is nearing saturation; the “limit” LED indicates that the temperature limiting circuits have triggered to prevent the system from overheating.

NETWORK ON: signals that connection to the network has been enabled.

TILT ANGLE: allows you to set the tilt angle of the sound beam. Negative angles conventionally refer to a sound beam tilted toward the lower part of the speaker;. The PC/SLAVE position brings the loudspeaker in data receiving mode, with the option of controlling it via the relevant software on the PC.

BEAMWIDTH: allows you to select the opening angle of the sound beam.

VOLUME: Adjusts the volume of the single loudspeaker.

PRESET: Selects 4 presets, each corresponding to a different equalization, based on the installation to be performed.

HP FILTER: selecting the control modifies the “hi-pass” filter to about 180Hz, thus allowing you to combine use of a subwoofer of the FBT SUBLINE series; in this case, to obtain the proper alignment of the signal delays of the DLA loudspeaker and sub, we recommend that you use the relevant “SUB OUT” signal output.

GND LIFT: electrical switch for the electrical separation between the mass and ground circuits, in order to avoid possible mass “loops”, which are the source of bothersome humming sound.

IN - LINK - SUB OUT: Balanced input/output sockets; “IN” allows the connection of pre-amplified signal, such as for instance the one in output from a mixer. “LINK” allows you to connect multiple loudspeakers to the same signal. USE “EUROBLOCK” SOCKETS FOR WALL CONNECTIONS.

IN-NETWORK-OUT: see the description in the “CONNECTION OF LOUDSPEAKERS” section.



VERTUS
DLA 1244A

ON: Indicates that the system is on.

PEAK/LIMIT: When the “peak” LED goes on, it indicates that the signal level is nearing saturation; the “limit” LED indicates that the temperature limiting circuits have triggered to prevent the system from overheating.

NETWORK ON: signals that connection to the network has been enabled.

TILT ANGLE: allows you to set the tilt angle of the sound beam. Negative angles conventionally refer to a sound beam tilted toward the lower part of the speaker. The PC/SLAVE position brings the loudspeaker in data receiving mode, with the option of controlling it via the relevant software on the PC.

BEAMWIDTH: allows you to select the opening angle of the sound beam.

VOLUME: Adjusts the volume of the single loudspeaker.

PRESET: Selects 4 presets, each corresponding to a different equalization, based on the installation to be performed.

HP FILTER: selecting the control modifies the “hi-pass” filter to about 180Hz, thus allowing you to combine use of a subwoofer of the FBT SUBLINE series; in this case, to obtain the proper alignment of the signal delays of the DLA loudspeaker and sub, we recommend that you use the relevant “SUB OUT” signal output.

GND LIFT: electrical switch for the electrical separation between the mass and ground circuits, in order to avoid possible mass “loops”, which are the source of bothersome humming sound.

IN - LINK - SUB OUT: Balanced input/output sockets; “IN” allows the connection of pre-amplified signal, such as for instance the one in output from a mixer. “LINK” allows you to connect multiple loudspeakers to the same signal. USE “EUROBLOCK” SOCKETS FOR WALL CONNECTIONS.

IN-NETWORK-OUT: see the description in the “CONNECTION OF LOUDSPEAKERS” section.



CONNECTION OF LOUDSPEAKERS

- *CONTROL FROM PC:* the connection uses the RS485 protocol to send and receive data between the PC and speaker. The PC must be connected via a USB cable to the USB-RS485 converter and from thence to the first speaker (NETWORK IN) using a standard Ethernet cable. Connect the loudspeakers in succession with Ethernet cables (from NETWORK OUT to NETWORK IN) and place the relevant RJ45 bridge on the output of the last speaker.

The succession of the speakers, starting with the first one identifiable on the software as the speaker adjacent to the "FRAME", must follow the order of the system as designed on the PC.

Connection to the PC, besides the supplied converter, requires the drivers necessary for the peripheral devices to function properly. The drivers are available directly on the www.ftdichip.com website; to properly install the converter, refer to the instructions available at the following link:
<http://www.ftdichip.com/Documents/InstallGuides.htm>



CODE: F36959

USB-RS485 CONVERTER

CONNECTION EXAMPLES

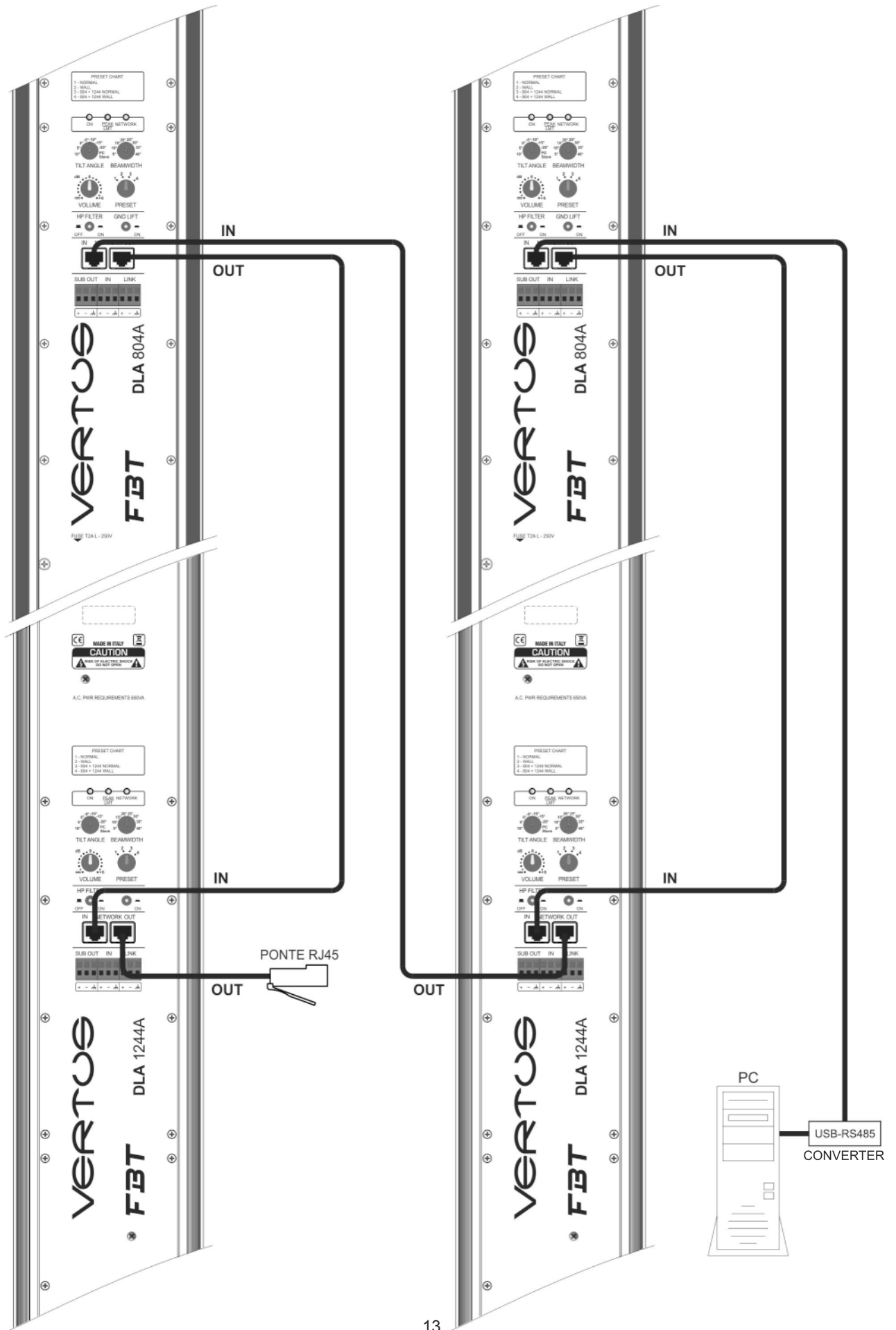

TECHNICAL SPECIFICATIONS

		DLA 804A	DLA 1244A
<i>CONFIGURATION</i>	<i>way</i>	8	16
<i>BUILT-IN AMPLIFIER CONT. RMS LF/HF</i>	<i>watt</i>	8 x 40	16 x 40
<i>BUILT-IN AMPLIFIER MAX. RMS LF/HF</i>	<i>watt</i>	8 x 50	16 x 50
<i>BUILT-IN AMPLIFIER MAX. PEAK LF/HF</i>	<i>watt</i>	8 x 100	16 x 100
<i>FREQUENCY RESPONSE</i>	<i>@-6dB</i>	120Hz - 20kHz	100Hz - 20kHz
<i>LOW FREQUENCY WOOFER</i>	<i>inch</i>	8 x 4" / coil 1"	12 x 4" - 1" coil
<i>HIGH FREQUENCY DRIVER</i>	<i>inch</i>	-----	4 x 1" - 1" coil
<i>MAX. SPL CONT/PEAK</i>	<i>dB</i>	120 / 123	123 / 126
<i>DISPERSION</i>	<i>H x V</i>	100° digital controlled	100° digital controlled
<i>INPUT IMPEDANCE</i>	<i>kOhm</i>	22	22
<i>CROSSOVER FREQUENCY</i>	<i>kHz</i>	3	1.8
<i>AC POWER REQUIREMENT</i>	<i>VA</i>	400	650
<i>INPUT CONNECTORS</i>		Euroblock	Euroblock
<i>POWER CORD</i>	<i>ft.</i>	16.4	16.4
<i>NET DIMENSIONS (WxHxD)</i>	<i>inch</i>	5.11 x 38 x 5.15	5.11 x 66.33x 5.15
<i>NET WEIGHT</i>	<i>lb</i>	26.66	48.50
<i>TRANSPORT DIMENSIONS (W_xHxD)</i>	<i>inch</i>	8.66 x 40.94 x 8.66	8.66 x 69.29 x 8.66
<i>TRANSPORT WEIGHT</i>	<i>lb</i>	31.96	54.01

WARNING: where affixed on the equipment or package, the barred waste bin sign indicates that the product must be separated from other waste at the end of its working life for disposal. At the end of use, the user must deliver the product to a suitable recycling centre or return it to the dealer when purchasing a new product. Adequate disposal of the decommissioned equipment for recycling, treatment and environmentally compatible disposal contributes in preventing potentially negative effects on the environment and health and promotes the reuse and/or recycling of equipment materials. Abusive product disposal by the user is punishable by law with administrative sanctions.



CODE 36190#07.2013

All informations included in this operating manual have been scrupulously controlled; however FBT is not responsible for eventual mistakes. FBT Elettronica SpA has the right to amend products and specifications without notice.