



Official Reseller :

TRADEMARKS & TRADE DRESS COPYRIGHT NOTICE:

Partial or total reproduction of this booklet might infringe one or more trade marks, trade dress, IPs, property and used by ProVideoInstruments Corp. For this reason, any reproduction, representation, adaptation, translation and/or transformation, in whole or in part, or transfer to another site or book is strictly prohibited & persecuted by US and international laws.

PROVIDEINSTRUMENTS / VEKOAX / MICROMOD / VECASER / VUMATRIX / MINIMOD / VECODER / are registered trademarks of ProVideoInstruments Corp, 7022 TPC Drive, Orlando FL, 32822 United States Of America. All Rights Are Reserved
Dolby is a registered Trademark of Dolby Laboratories

ProVideoInstruments reserves the right to change without prior notice any external and or functional characteristics of its products

BROADCAST PRODUCTS

Reference Guide

ULTRA-BT Broadcast Processors



The ULTRA-BT Broadcast Headends are the Perfect, Flexible & **Most cost-effective solution** to broadcast any SD / HD / 4K Diital Television services over ATSC, CABLE, ISDBT, DVBT, DVBC, Satellite, MMDS, IPTV with perfect video quality, stereo or multi-channel audio, and Hot-Swap Cards.

Encoders

SDI Encoders	PAGES 3 /4
HDMI Encoders	PAGES 5 /6
SDI + HDMI Encoders	PAGES 7 /8
CVBS Encoders	PAGES 9 /10

Encoders + Modulators

SDI Encoder Modulators	PAGES 11 /12
HDMI Encoder Modulators	PAGES 12 /14
SDI + HDMI Encoder Modulators	PAGES 15 /16
CVBS Encoder Modulators	PAGES 17 /18

Multi-RF Modulators

IPTV To Multi-RF Modulators	PAGES 19 /20
-----------------------------------	--------------

ON-AIR Modulators

ASI-IP Broadcast Modulators	PAGES 21 /22
-----------------------------------	--------------

ASI Over IP Transport

ASI Over IP Processors	PAGES 23 /24
------------------------------	--------------

Stat-Mux Re-Multiplexers / Transcoders

Re-Multiplexers & Transcoders	PAGES 25 /26
-------------------------------------	--------------

IRD Decoder

Integrated Receivers Decoders	PAGES 27 /28
-------------------------------------	--------------

Modular Headends

Modular Headends	PAGES 29 /30
------------------------	--------------

Video Distribution - Monitoring - Contribution

Video Over Coax - Matrix Over IP - IPTV Streaming	PAGES 31 /34
---	--------------



ProVideoInstruments - our Headquarters plant at 7022 TPC Drive - Orlando FL

PVI is a leading manufacturer of digital video broadcasting products, providing solutions for digital television transmissions & distribution in both SD HD and 4K over any media and network.

We also Proudly Serve:



ULTRA-BT SDI Broadcast Encoders



The ULTRA-BT-SDI Broadcast Video Encoder Series is the Perfect, Flexible & **Most cost-effective solution** to encode and broadcast any SD/HD SDI Video with perfect video quality, stereo or multi-channel audio, up to 12 independent channels per box, with ASI & IPTV simultaneous out and Hot-Swap Cards.

Key Benefits

- Multi-Channel Broadcast Encoder in 1RU Rack
- Flexible Compression MPEG2/H264 per channel
- Stereo or Multi-Channel pass-through Audio
- Expandable on site by adding Hot-Swap Cards
- Statistical Remux with Multiple ASI & IPTV I-O
- Completeness of features including EIT
- Ultimate Fiber & Optical Network Connections
- Hot-Swap serviceable cards & replacements
- Redundant Dual Power Supply
- Combine any feature you need in the same box

SDI ENCODERS



Key Facts

- Available with 2-4-6-8-12 3G SDI Inputs
- Mpeg2 / H.264 Video selectable per channel
- Stereo / Dolby / Dolby Digital Pass-Through
- Mpeg / AC3 / AAC Selectable per channel
- CC TXT Captioning over SDI
- Compatible ATSC - QAM - DVBT- DVBC - ISDBT
- Multiple Configurable ASI Stat Mux I-O / Remux
- Complete DVB PSI-SI - LCN - Static EIT
- Complete ATSC PSIP - TVCT - CVCT - Static EIT
- IPTV RJ45 + SFP Fiber I-O Multicast & Unicast
- Expandable On Site via Hot-Swap Cards
- Dual Redundant Power Supply
- Made in USA - 5 Years of Warranty

Block Diagram

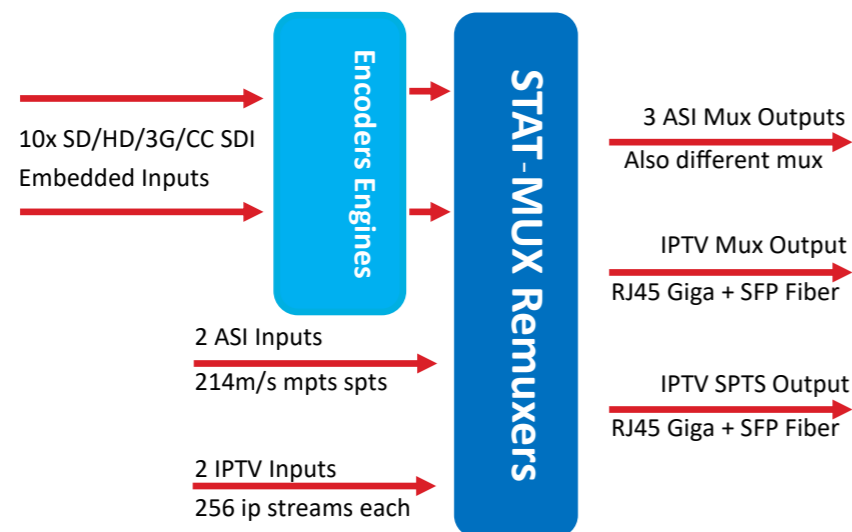

ULTRA-BT SDI Broadcast Encoders

Model Selector

2 CHANNELS - SD/HD/3G SDI



SKU: 0649070905930 ULTRA-BT-2SDI-ADMUX - 2 SDI In + 2 ASI In + 3 ASI Out + 2 IP In + 1 IP SPTS RJ+SFP Out + 1 IP MPTS RF-SFP Out - 4 Free Expansion Slots

4 CHANNELS - SD/HD/3G SDI



SKU: 0649070905947 ULTRA-BT-4SDI-ADMUX - 4 SDI In + 2 ASI In + 3 ASI Out + 2 IP In + 1 IP SPTS RJ+SFP Out + 1 IP MPTS RF-SFP Out - 3 Free Expansion Slots

6 CHANNELS - SD/HD/3G SDI



SKU: 0649070905954 ULTRA-BT-6SDI-ADMUX - 6 SDI In + 2 ASI In + 3 ASI Out + 2 IP In + 1 IP SPTS RJ+SFP Out + 1 IP MPTS RF-SFP Out - 2 Free Expansion Slots

8 CHANNELS - SD/HD/3G SDI



SKU: 0649070905961 ULTRA-BT-8SDI-ADMUX - 8 SDI In + 2 ASI In + 3 ASI Out + 2 IP In + 1 IP SPTS RJ+SFP Out + 1 IP MPTS RF-SFP Out - 1 Free Expansion Slots

10 CHANNELS - SD/HD/3G SDI



SKU: 0649070905978 ULTRA-BT-10SDI-ADMUX - 10 SDI In + 2 ASI In + 3 ASI Out + 2 IP In + 1 IP SPTS RJ+SFP Out + 1 IP MPTS RF-SFP Out

12 CHANNELS - SD/HD/3G SDI



SKU: 0649070905985 ULTRA-BT-12SDI - 12 SDI In + 1 ASI Out + 1 IP SPTS RJ+SFP Out + 1 IP MPTS RF-SFP Out

ULTRA-BT HDMI Broadcast Encoders



The ULTRA-BT-HDMI Broadcast Video Encoder Series is the Perfect, Flexible & **Most cost-effective solution** to encode and broadcast any HDMI Video with perfect video quality, stereo or multi-channel audio, up to 12 independent channels per box, with ASI & IPTV simultaneous out and Hot-Swap Cards.

Key Benefits

- Multi-Channel Broadcast Encoder in 1RU Rack
- Flexible Compression MPEG2/H264 per channel
- Stereo or Multi-Channel pass-through Audio
- Expandable on site by adding Hot-Swap Cards
- Statistical Remux with Multiple ASI & IPTV I-O
- Completeness of features including EIT
- Ultimate Fiber & Optical Network Connections
- Hot-Swap serviceable cards & replacements
- Redundant Dual Power Supply
- Combine any feature you need in the same box

HDMI ENCODERS



Key Facts

- Available with 2-4-6-8-12 HDMI Licensed Inputs
- Mpeg2 / H.264 Video selectable per channel
- Stereo / Dolby / Dolby Digital Pass-Through
- Mpeg / AC3 / AAC Selectable per channel
- CC TXT Captioning over BNC cvbs capture
- Compatible ATSC - QAM - DVBT- DVBC - ISDBT
- Multiple Configurable ASI Stat Mux I-O / Remux
- Complete DVB PSI-SI - LCN - Static EIT
- Complete ATSC PSIP - TVCT - CVCT - Static EIT
- IPTV RJ45 + SFP Fiber I-O Multicast & Unicast
- Expandable On Site via Hot-Swap Cards
- Dual Redundant Power Supply
- Made in USA - 5 Years of Warranty

Block Diagram

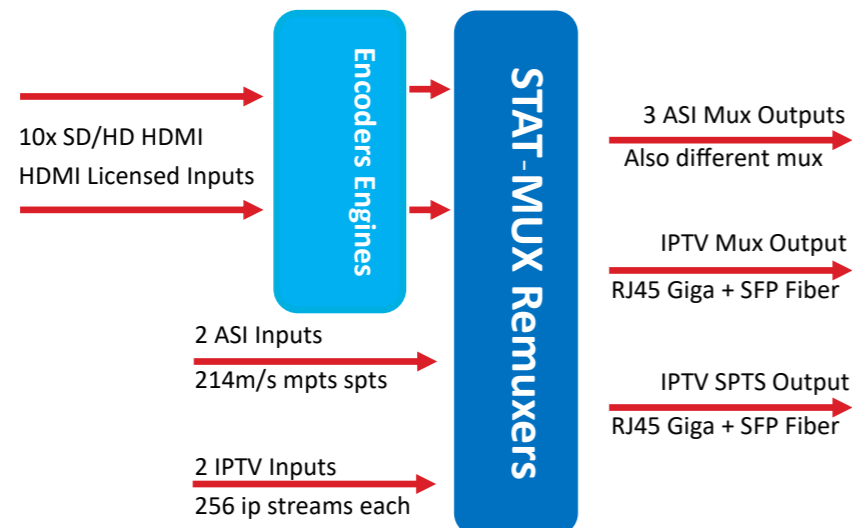

ULTRA-BT HDMI Broadcast Encoders

Model Selector

2 CHANNELS - HDMI



SKU: 0649070905992 ULTRA-BT-2HDMI-ADMUX - 2 HDMI In + 2 ASI In + 3 ASI Out + 2 IP In + 1 IP SPTS RJ+SFP Out + 1 IP MPTS RF-SFP Out - 4 Free Expansion Slots

4 CHANNELS - HDMI



SKU: 0649070906005 ULTRA-BT-4HDMI-ADMUX - 4 HDMI In + 2 ASI In + 3 ASI Out + 2 IP In + 1 IP SPTS RJ+SFP Out + 1 IP MPTS RF-SFP Out - 3 Free Expansion Slots

6 CHANNELS - HDMI



SKU: 0649070906012 ULTRA-BT-6HDMI-ADMUX - 6 HDMI In + 2 ASI In + 3 ASI Out + 2 IP In + 1 IP SPTS RJ+SFP Out + 1 IP MPTS RF-SFP Out - 2 Free Expansion Slots

8 CHANNELS - HDMI



SKU: 0649070906029 ULTRA-BT-8HDMI-ADMUX - 8 HDMI In + 2 ASI In + 3 ASI Out + 2 IP In + 1 IP SPTS RJ+SFP Out + 1 IP MPTS RF-SFP Out - 1 Free Expansion Slots

10 CHANNELS - HDMI



SKU: 0649070906036 ULTRA-BT-10HDMI-ADMUX - 10 HDMI In + 2 ASI In + 3 ASI Out + 2 IP In + 1 IP SPTS RJ+SFP Out + 1 IP MPTS RF-SFP Out

12 CHANNELS - HDMI



SKU: 0649070906043 ULTRA-BT-12HDMI - 12 HDMI In + 1 ASI Out + 1 IP SPTS RJ+SFP Out + 1 IP MPTS RF-SFP Out

ULTRA-BT SDI-HDMI

Broadcast Encoders



The ULTRA-BT-SDI-HDMI Broadcast Video Encoder Series is the Perfect, Flexible & **Most cost-effective solution** to encode and broadcast any mixed SDI/HDMI Video with perfect video quality, up to 12 independent channels per box, with ASI & IPTV simultaneous out and Hot-Swap Cards.

Key Benefits

- Multi-Channel Broadcast Encoder in 1RU Rack
- Flexible Compression MPEG2/H264 per channel
- Stereo or Multi-Channel pass-through Audio
- Expandable on site by adding Hot-Swap Cards
- Statistical Remux with Multiple ASI & IPTV I-O
- Completeness of features including EIT
- Ultimate Fiber & Optical Network Connections
- Hot-Swap serviceable cards & replacements
- Redundant Dual Power Supply
- Combine any feature you need in the same box

SDI+HDMI ENCODERS



Key Facts

- Available with 2-4-6-8-12 SDI/HDMI Inputs
- Mpeg2 / H.264 Video selectable per channel
- Stereo / Dolby / Dolby Digital Pass-Through
- Mpeg / AC3 / AAC Selectable per channel
- CC TXT Captioning capture and encoding
- Compatible ATSC - QAM - DVBT- DVBC - ISDBT
- Multiple Configurable ASI Stat Mux I-O / Remux
- Complete DVB PSI-SI - LCN - Static EIT
- Complete ATSC PSIP - TVCT - CVCT - Static EIT
- IPTV RJ45 + SFP Fiber I-O Multicast & Unicast
- Expandable On Site via Hot-Swap Cards
- Dual Redundant Power Supply
- Made in USA - 5 Years of Warranty

Block Diagram

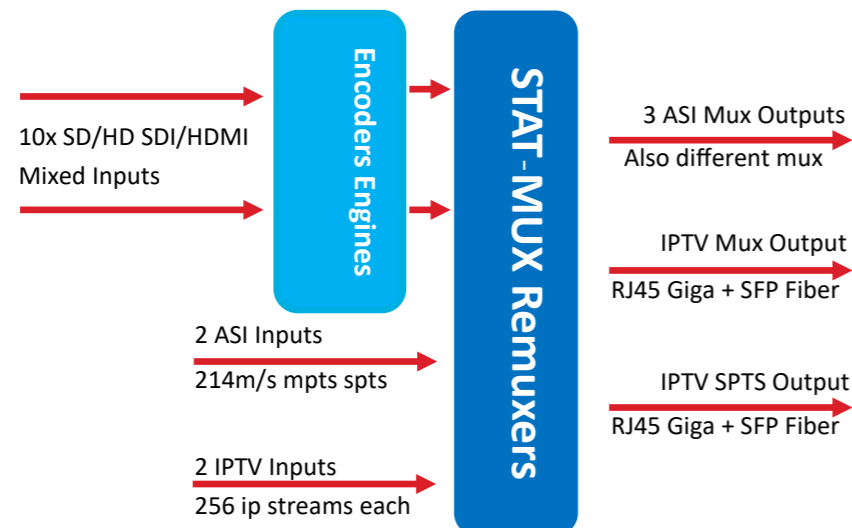

ULTRA-BT SDI-HDMI

Broadcast Encoders

Model Selector

2 SDI + 2 HDMI CHANNELS



SKU: 0649070906050 ULTRA-BT-2SDI-2HDMI-ADMUX - 2 SDI + 2 HDMI In + 2 ASI In + 3 ASI Out + 2 IP In + 1 IP SPTS RJ+SFP Out + 1 IP MPTS RF-SFP Out - 3 Expansion

2 SDI + 8 HDMI CHANNELS



SKU: 0649070906098 ULTRA-BT-2SDI-8HDMI-ADMUX - 2 SDI + 8 HDMI In + 2 ASI In + 3 ASI Out + 2 IP In + 1 IP SPTS RJ+SFP Out + 1 IP MPTS RF-SFP Out

4 SDI + 4 HDMI CHANNELS



SKU: 0649070906128 ULTRA-BT-4SDI-4HDMI-ADMUX - 4 SDI + 4 HDMI In + 2 ASI In + 3 ASI Out + 2 IP In + 1 IP SPTS RJ+SFP Out + 1 IP MPTS RF-SFP Out - 1 Expansion

4 SDI + 6 HDMI CHANNELS



SKU: 0649070906135 ULTRA-BT-4SDI-6HDMI-ADMUX - 4 SDI + 6 HDMI In + 2 ASI In + 3 ASI Out + 2 IP In + 1 IP SPTS RJ+SFP Out + 1 IP MPTS RF-SFP Out

6 SDI + 4 HDMI CHANNELS



SKU: 0649070906159 ULTRA-BT-6SDI-4HDMI-ADMUX - 6 SDI + 4 HDMI In + 2 ASI In + 3 ASI Out + 2 IP In + 1 IP SPTS RJ+SFP Out + 1 IP MPTS RF-SFP Out

8 SDI + 2 HDMI CHANNELS



SKU: 0649070906166 ULTRA-BT-8SDI-2HDMI-ADMUX - 8 SDI + 2 HDMI In + 2 ASI In + 3 ASI Out + 2 IP In + 1 IP SPTS RJ+SFP Out + 1 IP MPTS RF-SFP Out

ULTRA-BT CVBS

Broadcast Encoders



The ULTRA-BT-CVBS Broadcast Video Encoder Series is the Perfect, Flexible & **Most cost-effective solution** to encode and broadcast any 4:3 & 19:9 SD Composite Video with perfect video quality audio, up to 20 independent channels per box, with ASI & IPTV simultaneous out and Hot-Swap Cards.

Key Benefits

- Multi-Channel Broadcast Encoder in 1RU Rack
- Flexible Compression MPEG2/H264 per channel
- Professional 4:4:4 Input processing + TBC DNR
- Expandable on site by adding Hot-Swap Cards
- Statistical Remux with Multiple ASI & IPTV I-O
- Completeness of features including EIT
- Ultimate Fiber & Optical Network Connections
- Hot-Swap serviceable cards & replacements
- Redundant Dual Power Supply
- Combine any feature you need in the same box

CVBS ENCODERS



Key Facts

- Available with 4-8-12-16-20 CVBS Inputs
- Mpeg2 / H.264 Video selectable per channel
- Stereo / Dolby Stereo audio
- Mpeg / AC3 / AAC Selectable per channel
- CC TXT Captioning capture and encoding
- Compatible ATSC - QAM - DVBT- DVBC - ISDBT
- Multiple Configurable ASI Stat Mux I-O / Remux
- Complete DVB PSI-SI - LCN - Static EIT
- Complete ATSC PSIP - TVCT - CVCT - Static EIT
- IPTV RJ45 + SFP Fiber I-O Multicast & Unicast
- Expandable On Site via Hot-Swap Cards
- Dual Redundant Power Supply
- Made in USA - 5 Years of Warranty

Block Diagram

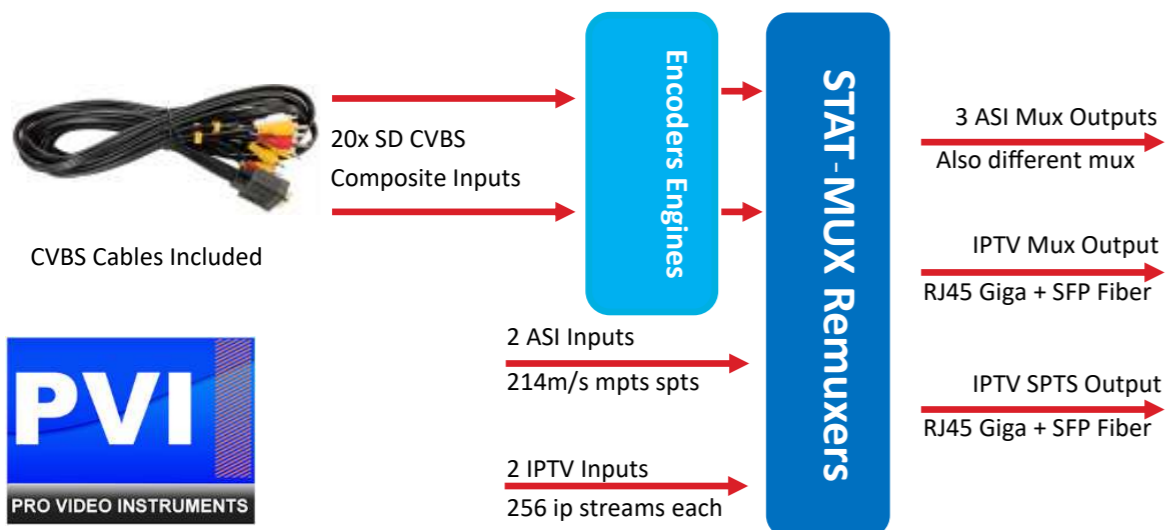

ULTRA-BT CVBS

Broadcast Encoders

Model Selector

4 CVBS CHANNELS



SKU: 0649070906616 ULTRA-BT-4CVBS-ADMUX - 4 CVBS In + 2 ASI In + 3 ASI Out + 2 IP In + 1 IP SPTS RJ+SFP Out + 1 IP MPTS RF-SFP Out - 4 Free Expansion Slots

8 CVBS CHANNELS



SKU: 0649070906623 ULTRA-BT-8CVBS-ADMUX - 8 CVBS In + 2 ASI In + 3 ASI Out + 2 IP In + 1 IP SPTS RJ+SFP Out + 1 IP MPTS RF-SFP Out - 3 Free Expansion Slots

12 CVBS CHANNELS



SKU: 0649070906630 ULTRA-BT-12CVBS-ADMUX - 12 CVBS In + 2 ASI In + 3 ASI Out + 2 IP In + 1 IP SPTS RJ+SFP Out + 1 IP MPTS RF-SFP Out - 2 Free Expansion Slots

16 CVBS CHANNELS



SKU: 0649070906647 ULTRA-BT-16CVBS-ADMUX - 16 CVBS In + 2 ASI In + 3 ASI Out + 2 IP In + 1 IP SPTS RJ+SFP Out + 1 IP MPTS RF-SFP Out - 1 Free Expansion Slot

20 CVBS CHANNELS



SKU: 0649070906654 ULTRA-BT-20CVBS-ADMUX - 20 CVBS In + 2 ASI In + 3 ASI Out + 2 IP In + 1 IP SPTS RJ+SFP Out + 1 IP MPTS RF-SFP Out

24 CVBS CHANNELS



SKU: 0649070906661 ULTRA-BT-24CVBS - 24 CVBS In + 1 ASI Out + 1 IP SPTS RJ+SFP Out + 1 IP MPTS RF-SFP Out

ULTRA-BT SDI-M Encoder+Modulators



The ULTRA-BT-SDI-M Broadcast Video Encoder & RF Modulator Series is the Perfect, Flexible & **Most cost-effective solution** to encode and broadcast any SD/HD SDI Video with perfect video quality, stereo or multi-channel audio, up to 10 independent channels per box, with ASI + IPTV + RF simultaneous out and Hot-Swap Cards.

Key Benefits

- Multi Broadcast Encoder Modulator in 1RU Rack
- Flexible Compression MPEG2/H264 per channel
- Stereo or Multi-Channel pass-through Audio
- Expandable on site by adding Hot-Swap Cards
- Statistical Remux with Multiple ASI & IPTV I-O
- Broadcast RF Out as ATSC / QAM / ISDBT / DVBT
- Completeness of features including EIT
- Ultimate Fiber & Optical Network Connections
- Hot-Swap serviceable cards & replacements
- Redundant Dual Power Supply
- Combine any feature you need in the same box

SDI ENCODER MODULATORS



Key Facts

- Available with 2-4-6-8-10 3G SDI Inputs
- Mpeg2 / H.264 Video selectable per channel
- Stereo / Dolby / Dolby Digital Pass-Through
- Mpeg / AC3 / AAC Selectable per channel
- CC TXT Captioning over SDI
- SW Switch to ATSC - QAM - DVBT- DVBC - ISDBT
- Broadcast RF out up to +5 dBm >47dbMER
- Multiple Configurable ASI Stat Mux I-O / Remux
- Complete DVB PSI-SI - LCN - Static EIT
- Complete ATSC PSIP - TVCT - CVCT - Static EIT
- IPTV RJ45 + SFP Fiber I-O Multicast & Unicast
- Expandable On Site via Hot-Swap Cards
- Dual Redundant Power Supply
- Made in USA - 5 Years of Warranty



Block Diagram

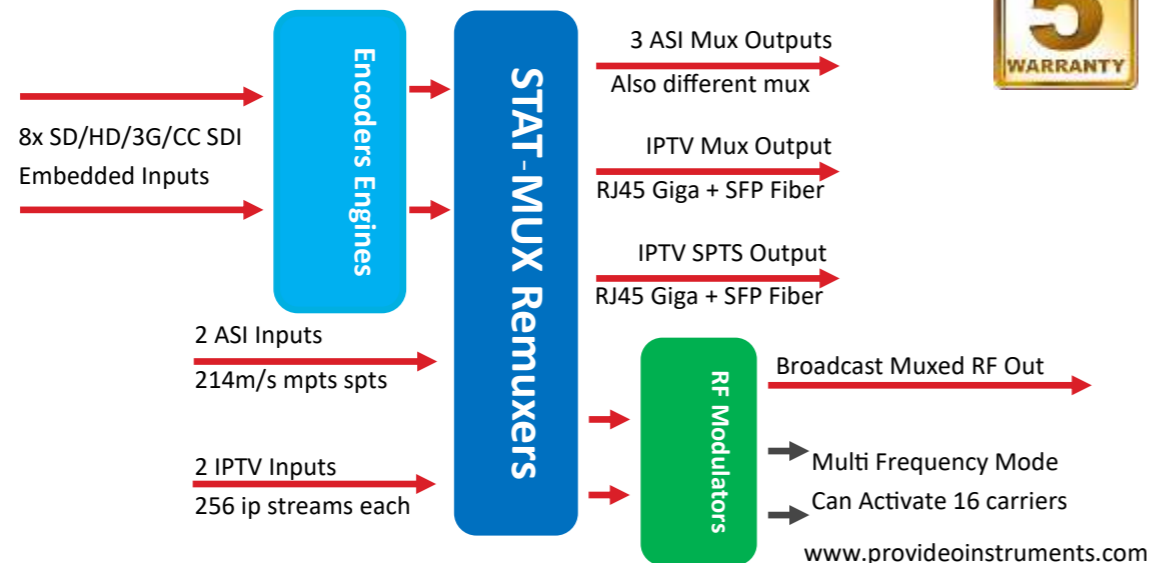

ULTRA-BT SDI-M Encoder+Modulators

Model Selector

2 CHANNELS - SD/HD/3G SDI - Modulator



SKU: 0649070906173 ULTRA-BT-2SDI-M-ADVMUX - 2 SDI In + 2 ASI In + 1 Broadcast Mux RF Out up to +5dBm adjustable selectable ATSC / QAM / ISDBT / DVBT Multi RF Out Mode up to 16 RF CARRIERS with 16 Muxers - 3 ASI Out + 4 IP 256 spts/mpts In Ea + 1 IP SPTS RJ+SFP Out + 1 IP MPTS RF-SFP Out - 3 Free Expansion Slots

4 CHANNELS - SD/HD/3G SDI - Modulator



SKU: 0649070906180 ULTRA-BT-4SDI-M-ADVMUX - 4 SDI In + 2 ASI In + 1 Broadcast Mux RF Out up to +5dBm adjustable selectable ATSC / QAM / ISDBT / DVBT Multi RF Out Mode up to 16 RF CARRIERS with 16 Muxers - 3 ASI Out + 4 IP 256 spts/mpts In Ea + 1 IP SPTS RJ+SFP Out + 1 IP MPTS RF-SFP Out - 2 Free Expansion Slots

6 CHANNELS - SD/HD/3G SDI - Modulator



SKU: 0649070906586 ULTRA-BT-6SDI-M-ADVMUX - 6 SDI In + 2 ASI In + 1 Broadcast Mux RF Out up to +5dBm adjustable selectable ATSC / QAM / ISDBT / DVBT Multi RF Out Mode up to 16 RF CARRIERS with 16 Muxers - 3 ASI Out + 4 IP 256 spts/mpts In Ea + 1 IP SPTS RJ+SFP Out + 1 IP MPTS RF-SFP Out - 1 Free Expansion

8 CHANNELS - SD/HD/3G SDI - Modulator



SKU: 0649070906593 ULTRA-BT-8SDI-M-ADVMUX - 8 SDI In + 2 ASI In + 1 Broadcast Mux RF Out up to +5dBm adjustable selectable ATSC / QAM / ISDBT / DVBT Multi RF Out Mode up to 16 RF CARRIERS with 16 Muxers - 3 ASI Out + 4 IP 256 spts/mpts In Ea + 1 IP SPTS RJ+SFP Out + 1 IP MPTS RF-SFP Out

10 CHANNELS - SD/HD/3G SDI - Modulator



SKU: 0649070906609 ULTRA-BT-10SDI-M - 10 SDI In + 1 Broadcast Mux RF Out up to +5dBm adjustable selectable ATSC / QAM / ISDBT / DVBT Multi RF Out Mode up to 16 RF CARRIERS with 16 Muxers - 1 ASI Out + 4 IP 256 spts/mpts In Ea + 1 IP SPTS RJ+SFP Out + 1 IP MPTS RF-SFP Out

ULTRA-BT HDMI-M Encoder+Modulators



The ULTRA-BT-HDMI-M Broadcast Video Encoder & RF Modulator Series is the Perfect, Flexible & **Most cost-effective solution** to encode and broadcast any HDMI Video with perfect video quality, stereo or multi-channel audio, up to 10 independent channels per box, with ASI + IPTV + RF simultaneous out and Hot-Swap Cards.

Key Benefits

- Multi Broadcast Encoder Modulator in 1RU Rack
- Flexible Compression MPEG2/H264 per channel
- Stereo or Multi-Channel pass-through Audio
- Expandable on site by adding Hot-Swap Cards
- Statistical Remux with Multiple ASI & IPTV I-O
- Broadcast RF Out as ATSC / QAM / ISDBT / DVBT
- Completeness of features including EIT
- Ultimate Fiber & Optical Network Connections
- Hot-Swap serviceable cards & replacements
- Redundant Dual Power Supply
- Combine any feature you need in the same box



Key Facts

- Available with 2-4-6-8-10 Licensed HDMI Inputs
- Mpeg2 / H.264 Video selectable per channel
- Stereo / Dolby / Dolby Digital Pass-Through
- Mpeg / AC3 / AAC Selectable per channel
- CC TXT Captioning over BNC cvbs Capture
- SW Switch to ATSC - QAM - DVBT- DVBC - ISDBT
- Broadcast RF out up to +5 dBm >47dbMER
- Multiple Configurable ASI Stat Mux I-O / Remux
- Complete DVB PSI-SI - LCN - Static EIT
- Complete ATSC PSIP - TVCT - CVCT - Static EIT
- IPTV RJ45 + SFP Fiber I-O Multicast & Unicast
- Expandable On Site via Hot-Swap Cards
- Dual Redundant Power Supply
- Made in USA - 5 Years of Warranty

Block Diagram

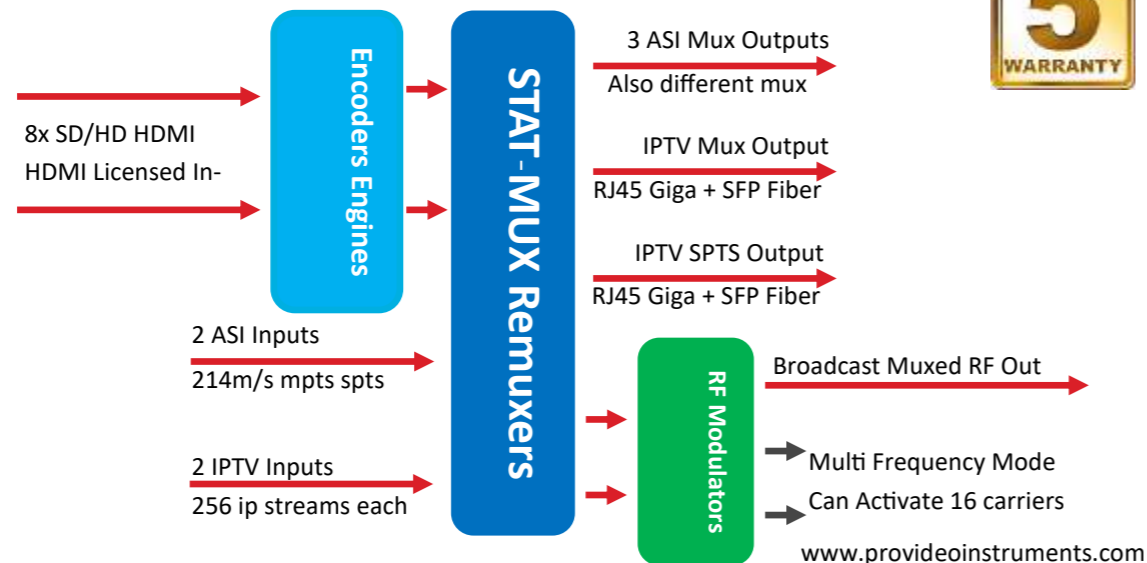

ULTRA-BT HDMI-M Encoder+Modulators

Model Selector

2 CHANNELS - HDMI - Modulator



SKU: 0649070906678 ULTRA-BT-2HDMI-M-ADVMUX - 2 HDMI In + 2 ASI In + 1 Broadcast Mux RF Out up to +5dBm adjustable selectable ATSC / QAM / ISDBT / DVBT Multi RF Out Mode up to 16 RF CARRIERS with 16 Muxers - 3 ASI Out + 4 IP 256 spts/mpts In Ea + 1 IP SPTS RJ+SFP Out + 1 IP MPTS RF-SFP Out - 3 Free Expansion Slots

4 CHANNELS - HDMI - Modulator



SKU: 0649070906685 ULTRA-BT-4HDMI-M-ADVMUX - 4 HDMI In + 2 ASI In + 1 Broadcast Mux RF Out up to +5dBm adjustable selectable ATSC / QAM / ISDBT / DVBT Multi RF Out Mode up to 16 RF CARRIERS with 16 Muxers - 3 ASI Out + 4 IP 256 spts/mpts In Ea + 1 IP SPTS RJ+SFP Out + 1 IP MPTS RF-SFP Out - 2 Free Expansion Slots

6 CHANNELS - HDMI - Modulator



SKU: 0649070906692 ULTRA-BT-6HDMI-M-ADVMUX - 6 HDMI In + 2 ASI In + 1 Broadcast Mux RF Out up to +5dBm adjustable selectable ATSC / QAM / ISDBT / DVBT Multi RF Out Mode up to 16 RF CARRIERS with 16 Muxers - 3 ASI Out + 4 IP 256 spts/mpts In Ea + 1 IP SPTS RJ+SFP Out + 1 IP MPTS RF-SFP Out - 1 Free Expansion Slots

8 CHANNELS - HDMI - Modulator



SKU: 0649070906708 ULTRA-BT-8HDMI-M-ADVMUX - 8 HDMI In + 2 ASI In + 1 Broadcast Mux RF Out up to +5dBm adjustable selectable ATSC / QAM / ISDBT / DVBT Multi RF Out Mode up to 16 RF CARRIERS with 16 Muxers - 3 ASI Out + 4 IP 256 spts/mpts In Ea + 1 IP SPTS RJ+SFP Out + 1 IP MPTS RF-SFP Out

10 CHANNELS - HDMI - Modulator



SKU: 0649070906715 ULTRA-BT-10HDMI-M - 10 HDMI In + 1 Broadcast Mux RF Out up to +5dBm adjustable selectable ATSC / QAM / ISDBT / DVBT Multi RF Out Mode up to 16 RF CARRIERS with 16 Muxers - 1 ASI Out + 4 IP 256 spts/mpts In Ea + 1 IP SPTS RJ+SFP Out + 1 IP MPTS RF-SFP Out

ULTRA-BT SDI-HDMI-M Encoder+Modulators



The ULTRA-BT-SDI-HDMI-M Broadcast Video Encoder & RF Modulator Series is the Perfect, Flexible & **Most cost-effective solution** to encode and broadcast a mix of any SDI & HDMI Video with perfect video quality, stereo or multi-channel audio, up to 10 independent channels per box, with ASI + IPTV + RF simultaneous out and Hot-Swap Cards.

Key Benefits

- Multi Broadcast Encoder Modulator in 1RU Rack
- Flexible Compression MPEG2/H264 per channel
- Stereo or Multi-Channel pass-through Audio
- Expandable on site by adding Hot-Swap Cards
- Statistical Remux with Multiple ASI & IPTV I-O
- Broadcast RF Out as ATSC / QAM / ISDBT / DVBT
- Completeness of features including EIT
- Ultimate Fiber & Optical Network Connections
- Hot-Swap serviceable cards & replacements
- Redundant Dual Power Supply
- Combine any feature you need in the same box



Key Facts

- Available with 2-4-6-8-10 SDI / HDMI Inputs
- Mpeg2 / H.264 Video selectable per channel
- Stereo / Dolby / Dolby Digital Pass-Through
- Mpeg / AC3 / AAC Selectable per channel
- CC TXT Captioning over BNC cvbs Capture
- SW Switch to ATSC - QAM - DVBT- DVBC - ISDBT
- Broadcast RF out up to +5 dBm >47dbMER
- Multiple Configurable ASI Stat Mux I-O / Remux
- Complete DVB PSI-SI - LCN - Static EIT
- Complete ATSC PSIP - TVCT - CVCT - Static EIT
- IPTV RJ45 + SFP Fiber I-O Multicast & Unicast
- Expandable On Site via Hot-Swap Cards
- Dual Redundant Power Supply
- Made in USA - 5 Years of Warranty

Block Diagram

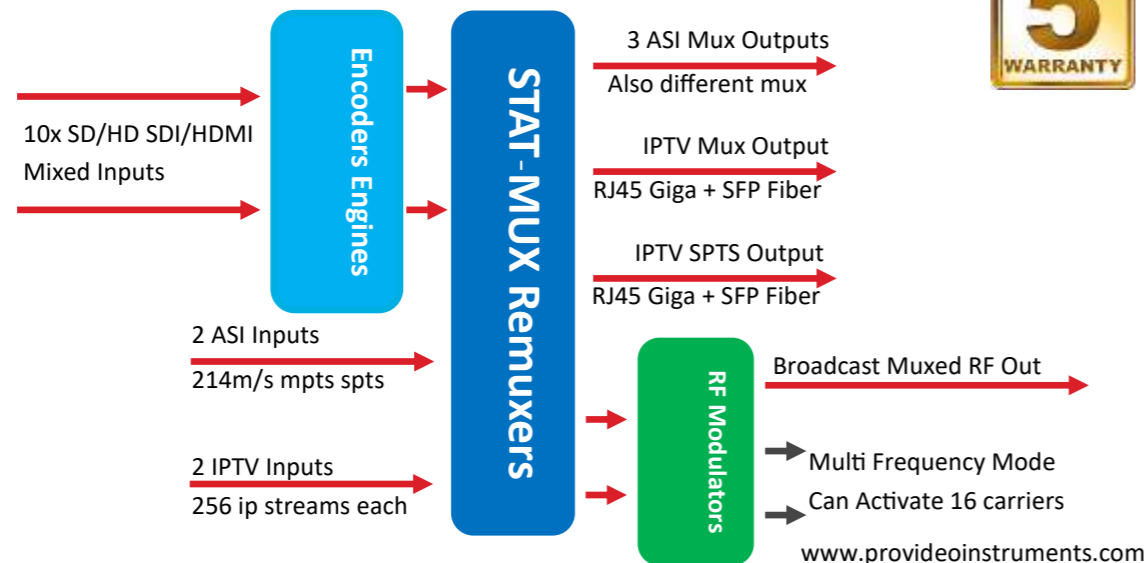

ULTRA-BT SDI-HDMI-M Encoder+Modulators Model Selector

2 SDI + 2 HDMI - 4 Channels Modulator



SKU: 0649070906722 ULTRA-BT-2SDI-2HDMI-M-ADVMUX - 2 SDI In + 2 HDMI In + 2 ASI In + 1 Broadcast Mux RF Out up to +5dBm adjustable selectable ATSC / QAM / ISDBT / DVBT - Multi RF Out Mode up to 16 RF CARRIERS with 16 Muxers - 3 ASI Out + 4 IP 256 spts/mpts In Ea + 1 IP SPTS RJ+SFP Out + 1 IP MPTS RF-SFP

2 SDI + 4 HDMI - 6 Channels Modulator



SKU: 0649070906739 ULTRA-BT-2SDI-4HDMI-M-ADVMUX - 2 SDI In + 4 HDMI In + 2 ASI In + 1 Broadcast Mux RF Out up to +5dBm adjustable selectable ATSC / QAM / ISDBT / DVBT - Multi RF Out Mode up to 16 RF CARRIERS with 16 Muxers - 3 ASI Out + 4 IP 256 spts/mpts In Ea + 1 IP SPTS RJ+SFP Out + 1 IP MPTS RF-SFP

2 SDI + 6 HDMI - 8 Channels Modulator



SKU: 0649070906746 ULTRA-BT-2SDI-6HDMI-M-ADVMUX - 2 SDI In + 6 HDMI In + 2 ASI In + 1 Broadcast Mux RF Out up to +5dBm adjustable selectable ATSC / QAM / ISDBT / DVBT - Multi RF Out Mode up to 16 RF CARRIERS with 16 Muxers - 3 ASI Out + 4 IP 256 spts/mpts In Ea + 1 IP SPTS RJ+SFP Out + 1 IP MPTS RF-SFP

4 SDI + 2 HDMI - 6 Channels Modulator



SKU: 0649070906753 ULTRA-BT-4SDI-2HDMI-M-ADVMUX - 4 SDI In + 2 HDMI In + 2 ASI In + 1 Broadcast Mux RF Out up to +5dBm adjustable selectable ATSC / QAM / ISDBT / DVBT - Multi RF Out Mode up to 16 RF CARRIERS with 16 Muxers - 3 ASI Out + 4 IP 256 spts/mpts In Ea + 1 IP SPTS RJ+SFP Out + 1 IP MPTS RF-SFP

4 SDI + 4 HDMI - 8 Channels Modulator



SKU: 0649070906760 ULTRA-BT-4SDI-4HDMI-M-ADVMUX - 4 SDI In + 4 HDMI In + 2 ASI In + 1 Broadcast Mux RF Out up to +5dBm adjustable selectable ATSC / QAM / ISDBT / DVBT - Multi RF Out Mode up to 16 RF CARRIERS with 16 Muxers - 3 ASI Out + 4 IP 256 spts/mpts In Ea + 1 IP SPTS RJ+SFP Out + 1 IP MPTS RF-SFP

6 SDI + 2 HDMI - 8 Channels Modulator



SKU: 0649070906777 ULTRA-BT-6SDI-2HDMI-M-ADVMUX - 6 SDI In + 2 HDMI In + 2 ASI In + 1 Broadcast Mux RF Out up to +5dBm adjustable selectable ATSC / QAM / ISDBT / DVBT - Multi RF Out Mode up to 16 RF CARRIERS with 16 Muxers - 3 ASI Out + 4 IP 256 spts/mpts In Ea + 1 IP SPTS RJ+SFP Out + 1 IP MPTS RF-SFP

ULTRA-BT CVBS-M Encoder+Modulators



The ULTRA-BT-CVBS-M Broadcast Video Encoder & RF Modulator Series is the Perfect, Flexible & **Most cost-effective solution** to encode and broadcast any 4:3 & 16:9 SD CVBS Video with perfect quality, up to 10 independent channels per box, with ASI + IPTV + RF simultaneous out and Hot-Swap Cards.

Key Benefits

- Multi Broadcast Encoder Modulator in 1RU Rack
- Flexible Compression MPEG2/H264 per channel
- Professional 4:4:4 Input processing + TBC DNR
- Expandable on site by adding Hot-Swap Cards
- Statistical Remux with Multiple ASI & IPTV I-O
- Broadcast RF Out as ATSC / QAM / ISDBT / DVBT
- Completeness of features including EIT
- Ultimate Fiber & Optical Network Connections
- Hot-Swap serviceable cards & replacements
- Redundant Dual Power Supply
- Combine any feature you need in the same box



Key Facts

- Available with 4-8-12-16-20 CVBS Inputs
- Mpeg2 / H.264 Video selectable per channel
- Stereo / Dolby Stereo audio
- Mpeg / AC3 / AAC Selectable per channel
- CC TXT Captioning over BNC cvbs Capture
- SW Switch to ATSC - QAM - DVBT- DVBC - ISDBT
- Broadcast RF out up to +5 dBm >47dbMER
- Multiple Configurable ASI Stat Mux I-O / Remux
- Complete DVB PSI-SI - LCN - Static EIT
- Complete ATSC PSIP - TVCT - CVCT - Static EIT
- IPTV RJ45 + SFP Fiber I-O Multicast & Unicast
- Expandable On Site via Hot-Swap Cards
- Dual Redundant Power Supply
- Made in USA - 5 Years of Warranty

Block Diagram

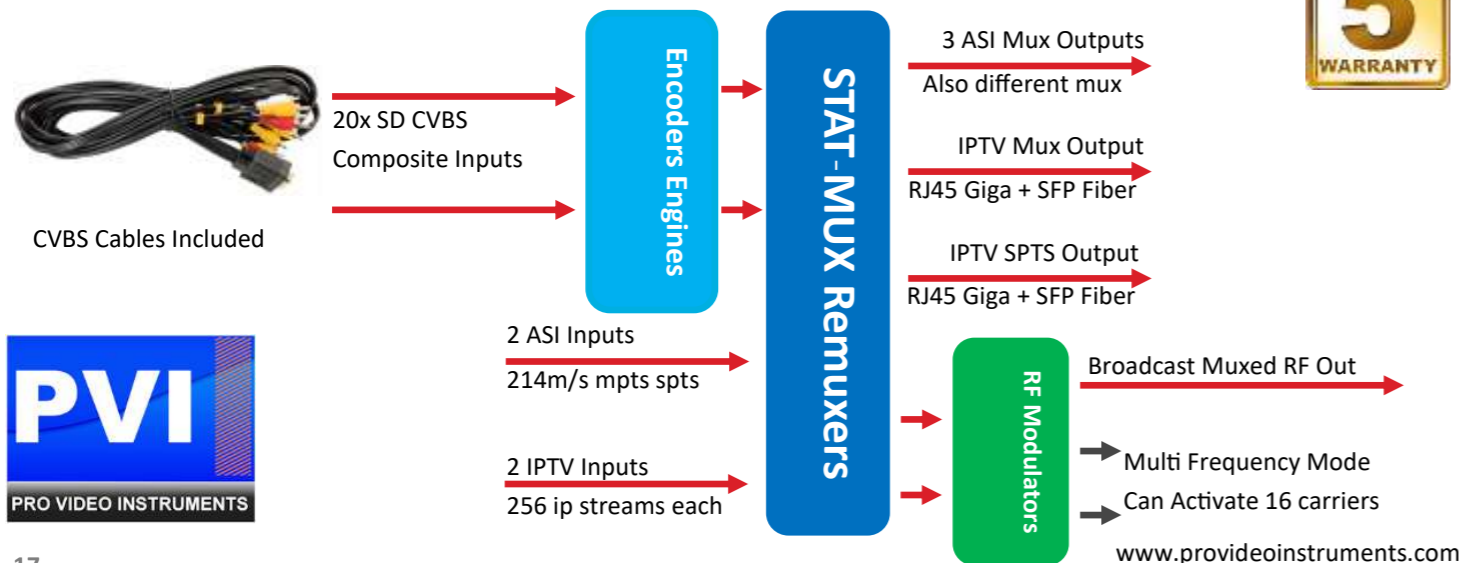

ULTRA-BT CVBS-M Encoder+Modulators Model Selector

4 CHANNELS - CVBS - Modulator



SKU: 0649070906784 ULTRA-BT-4CVBS-M-ADVMUX - 4 CVBS In + 2 ASI In + 1 Broadcast Mux RF Out up to +5dBm adjustable selectable ATSC / QAM / ISDBT / DVBT Multi RF Out Mode up to 16 RF CARRIERS with 16 Muxers - 3 ASI Out + 4 IP 256 spts/mpts In Ea + 1 IP SPTS RJ+SFP Out + 1 IP MPTS RF-SFP Out - 3 Free Expansion Slots

8 CHANNELS - CVBS - Modulator



SKU: 0649070906791 ULTRA-BT-8CVBS-M-ADVMUX - 8 CVBS In + 2 ASI In + 1 Broadcast Mux RF Out up to +5dBm adjustable selectable ATSC / QAM / ISDBT / DVBT Multi RF Out Mode up to 16 RF CARRIERS with 16 Muxers - 3 ASI Out + 4 IP 256 spts/mpts In Ea + 1 IP SPTS RJ+SFP Out + 1 IP MPTS RF-SFP Out - 2 Free Expansion Slots

12 CHANNELS - CVBS - Modulator



SKU: 0649070906807 ULTRA-BT-12CVBS-M-ADVMUX - 12 CVBS In + 2 ASI In + 1 Broadcast Mux RF Out up to +5dBm adjustable selectable ATSC / QAM / ISDBT / DVBT Multi RF Out Mode up to 16 RF CARRIERS with 16 Muxers - 3 ASI Out + 4 IP 256 spts/mpts In Ea + 1 IP SPTS RJ+SFP Out + 1 IP MPTS RF-SFP Out - 1 Free Expansion Slot

16 CHANNELS - CVBS - Modulator



SKU: 0649070906821 ULTRA-BT-16CVBS-M-ADVMUX - 16 CVBS In + 2 ASI In + 1 Broadcast Mux RF Out up to +5dBm adjustable selectable ATSC / QAM / ISDBT / DVBT Multi RF Out Mode up to 16 RF CARRIERS with 16 Muxers - 3 ASI Out + 4 IP 256 spts/mpts In Ea + 1 IP SPTS RJ+SFP Out + 1 IP MPTS RF-SFP Out

20 CHANNELS - CVBS - Modulator



SKU: 0649070906838 ULTRA-BT-20CVBS-M - 20 CVBS In + 2 ASI In + 1 Broadcast Mux RF Out up to +5dBm adjustable selectable ATSC / QAM / ISDBT / DVBT Multi RF Out Mode up to 16 RF CARRIERS with 16 Muxers - 3 ASI Out + 4 IP 256 spts/mpts In Ea + 1 IP SPTS RJ+SFP Out + 1 IP MPTS RF-SFP Out

ULTRA-BT IPTV-M

IPTV To RF Modulators



The ULTRA-BT-IPTV-M Broadcast IPTV To RF Modulator Series is the Perfect, Flexible & **Most cost-effective solution** to receive Hundreds of IPTV Streaming channels from any network, and convert them back into regular Broadcast RF Channels you can scan and watch on regular TVs, or Re-Multiplex and Re-Broadcast over the Air or any Cable Network.

Key Benefits

- Multi Channel IPTV to RF Modulator in 1RU Rack
- Up to 1024 IP Streams Input per each RF module
- Any Unicast & Multicast - SPTS & MPTS Stream
- Can Receive from any Lan / Wan / Internet
- Expandable on site by adding Hot-Swap Cards
- Set Module RF as ATSC / QAM / ISDBT / DVBT
- Activate up to 16 RF Channels per each Module
- Full Re-Multiplexer per each RF Channel Out
- Around 60 HD or 120 SD TV Services per module
- Redundant Dual Power Supply
- Simple Installation via Web Browser login



Key Facts

- Modular Design—16 RF Channels per Module
- Works in Adjacent and Non Adjacent RF modes
- Receive up to 1024 Streams per module
- Each RF out Channel has a Full Remultiplexer
- SW Switch to ATSC - QAM - DVBT- DVBC - ISDBT
- Support for any SD/HD/4K Services
- Broadcast RF out up to +5 dBm >47dbMER
- Complete DVB PSI-SI - LCN - Static EIT
- Complete ATSC PSIP - TVCT - CVCT - Static EIT
- Can Re-Mux and Re-Stream to IP network
- SimulCrypt CAS - up to 5 CAS Servers
- Dual Redundant Power Supply
- Made in USA - 5 Years of Warranty



Block Diagram per each Module

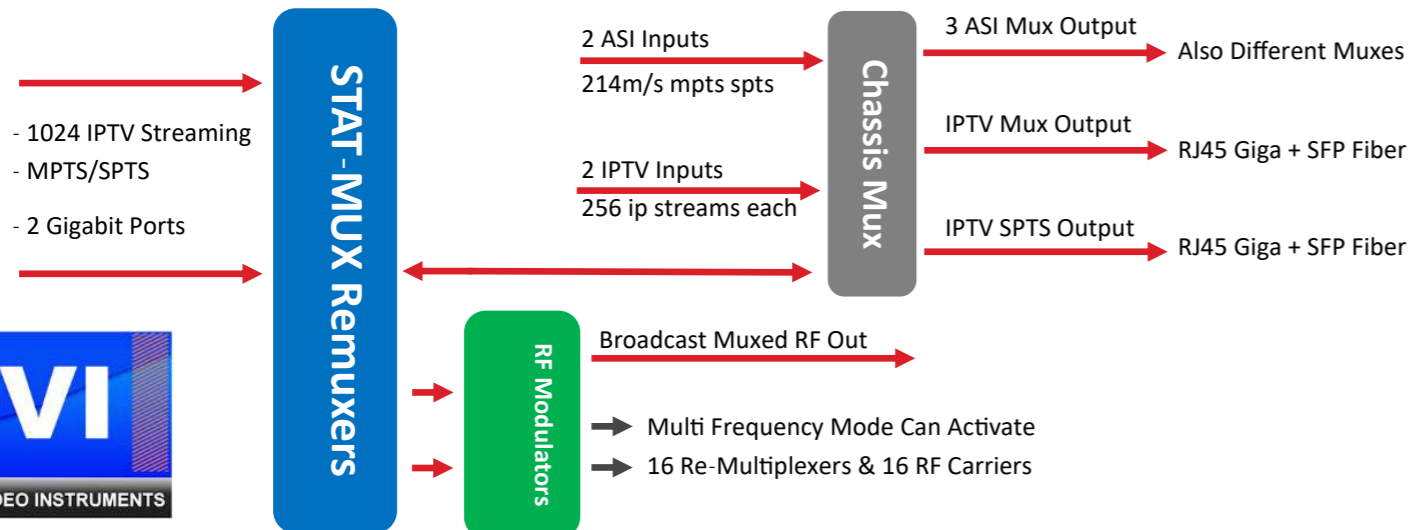

ULTRA-BT IPTV-M

IPTV To RF Modulators

Model Selector

60 HD / 120 SD IPTV to RF Modulator (16 CARRIERS)



SKU: 0649070906845 ULTRA-BT-ONEMOD-ADVMUX - 1024 IPTV IN over 2x RJ45 + 1 Broadcast RF Out up to +5dBm adjustable selectable ATSC / QAM / ISDBT / DVBT Multi RF Out Mode up to 16 RF CARRIERS with 16 Muxers - 2 ASI In + 3 ASI Out + 2 AUX 256 IP spts/mpts In + 1 IP SPTS RJ+SFP Out + 1 IP MPTS RF-SFP Out - 4 Free

120 HD / 240 SD IPTV to RF Modulator (32 CARRIERS)



SKU: 0649070906852 ULTRA-BT-TWOMOD-ADVMUX - 2048 IPTV IN over 4x RJ45 + 2 Broadcast RF Out up to +5dBm adjustable selectable ATSC / QAM / ISDBT / DVBT Multi RF Out Mode up to 32 RF CARRIERS with 32 Muxers - 2 ASI In + 3 ASI Out + 2 AUX 256 IP spts/mpts In + 1 IP SPTS RJ+SFP Out + 1 IP MPTS RF-SFP Out - 3 Free

180 HD / 360 SD IPTV to RF Modulator (48 CARRIERS)



SKU: 0649070906876 ULTRA-BT-THREEMOD-ADVMUX - 3072 IPTV IN over 6x RJ45 + 3 Broadcast RF Out up to +5dBm adjustable selectable ATSC / QAM / ISDBT / DVBT Multi RF Out Mode up to 48 RF CARRIERS with 48 Muxers - 2 ASI In + 3 ASI Out + 2 AUX 256 IP spts/mpts In + 1 IP SPTS RJ+SFP Out + 1 IP MPTS RF-SFP Out - 2 Free

240 HD / 480 SD IPTV to RF Modulator (64 CARRIERS)



SKU: 0649070906883 ULTRA-BT-FOURMOD-ADVMUX - 4096 IPTV IN over 8x RJ45 + 4 Broadcast RF Out up to +5dBm adjustable selectable ATSC / QAM / ISDBT / DVBT Multi RF Out Mode up to 64 RF CARRIERS with 64 Muxers - 2 ASI In + 3 ASI Out + 2 AUX 256 IP spts/mpts In + 1 IP SPTS RJ+SFP Out + 1 IP MPTS RF-SFP Out - 1 Free

300 HD / 600 SD IPTV to RF Modulator (80 CARRIERS)



SKU: 0649070906890 ULTRA-BT-FIVEMOD-ADVMUX - 5120 IPTV IN over 10x RJ45 + 5 Broadcast RF Out up to +5dBm adjustable selectable ATSC / QAM / ISDBT / DVBT Multi RF Out Mode up to 80 RF CARRIERS with 80 Muxers - 2 ASI In + 3 ASI Out + 2 AUX 256 IP spts/mpts In + 1 IP SPTS RJ+SFP Out + 1 IP MPTS RF-SFP Out

360 HD / 720 SD IPTV to RF Modulator (96 CARRIERS)



SKU: 0649070906906 ULTRA-BT-SIXMOD - 6144 IPTV IN over 12x RJ45 + 6 Broadcast RF Out up to +5dBm adjustable selectable ATSC / QAM / ISDBT / DVBT Multi RF Out Mode up to 96 RF CARRIERS with 96 Muxers - 1 ASI Out + 1 IP SPTS RJ+SFP Out + 1 IP MPTS RF-SFP Out

IPTV TO RF MODULATORS

ULTRA-BT ONAIR-M

Transmission RF Modulators



The ULTRA-BT-ONAIR-M Broadcast RF Modulator Series is the Perfect, Flexible & **Most cost-effective solution** to Broadcast On-air in ATSC / ISDBT / DVBT standard, with the ability to receive the services via STL, ASI, IP, Antenna, Remux with Descriptors and Channel information, and output one Full Broadcast RF Channel with level up to 0dBm, ready to pilot any existing Transmitter.

Key Benefits

- Broadcast RF Modulator in 1RU Rack
- Receive Services from ASI & IP
- Stat-Mux Re-Multiplexer to create the Local Mux
- Direct Drives any Amplifier providing 0dBm level
- Agile 30—1000 Mhz @ 1 KHz Steps
- Software Changeable RF out ATSC / ISDBT / DVBT
- Full Broadcast 47 dB MER - 55 dB Shoulders
- Zero Harmonics & Spurious - Full Digital
- 4 Free Slots to add special options
- Redundant Dual Power Supply

BROADCAST MODULATOR



Key Facts

- Up to 4 ASI SPTS/MPTS Inputs
- Up to 2 IPTV Network Inputs - SPTS/MPTS
- Stat Mux Re-Multiplexer to combine Services
- Complete DVB PSI-SI - LCN - Static EIT
- Complete ATSC PSIP - TVCT - Static EIT
- Support for any SD/HD/4K Services PAL/NTSC
- Broadcast RF out up to 0 dBm >47dbMER
- Software Load Switch to ATSC - DVBT – ISDBT
- ASI Mux Output & IPTV output to Re-Distribute
- Optional RF TUNER CARD for Antenna Feeds
- Optional Encoders & Transcoder Cards
- Dual Redundant Power Supply
- Made in USA - 5 Years of Warranty



Block Diagram

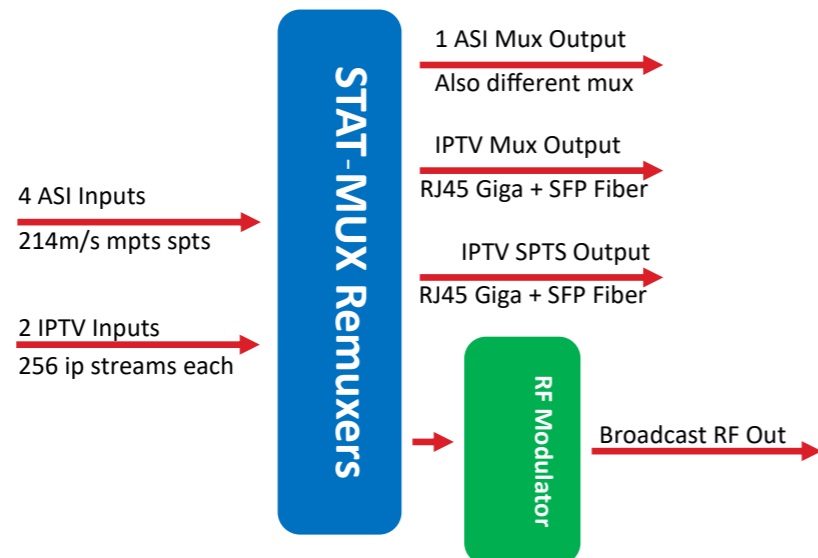

ULTRA-BT ONAIR-M

Transmission RF Modulators

Model Selector

IP/ASI IN—Broadcast Transmission RF Modulator



SKU: 0649070906920 ULTRA-BT-BROADCASTMOD-ADVMUX - 2x RJ45 IPTV SPTS/MPTS In + 4x ASI SPTS/MPTS In + 1 ASI MUX Out + 2 IP SPTS & 2 IP MPTS RJ45/SFP Out
1 Broadcast RF Out up to +0dBm adjustable selectable ATSC/ISDBT/DVBT via SW load - 30 to 950 Mhz @ 1 KHz step - MER 47dB - Shoulders 55 dB - 4 Free Expansion

Plug-In Options

RF TUNER IN OPTION



- SKU: 0649070903998 4x ATSC 8VSB TUNER CARD - Receives up to 4 simultaneous COMPLETE TRANSPONDERS (all services) from 4 different ATSC Off Air Frequencies
- SKU: 0649070904018 4x ISDBT TUNER CARD - Receives up to 4 simultaneous COMPLETE TRANSPONDERS (all services) from 4 different ISDBT Off Air Frequencies
- SKU: 0649070904025 4x DVBT TUNER CARD - Receives up to 4 simultaneous COMPLETE TRANSPONDERS (all services) from 4 different DVBT Off Air Frequencies
- SKU: 0649070904025 4x QAM CABLE TUNER CARD - Receives up to 4 simultaneous COMPLETE TRANSPONDERS (all services) from 4 different QAM Frequencies

Local Video Injection - VIDEO ENCODER OPTIONS



- SKU: 0649070903974 4x CVBS Composite via Cable Adaptor (included) 4:3 16:9 PAL/NTSC + CC - Selectable Mpeg2 / H.264 Video - Stereo MpegL2 / AC3 / AAC
- SKU: 0649070903844 4x Licensed HDMI Inputs - SD/HD/1080p - Stereo & Multi-Ch Audio—H.264 Video any Level/Profile - MpegL2 / AC3 / AAC / Dolby Pass Through
- SKU: 0649070903851 2x Licensed HDMI Inputs - SD/HD/1080p + CC - Stereo & Multi-Ch Audio - Selectable Mpeg2 / H.264 Video - MpegL2 / AC3 / AAC / Dolby Pass
- SKU: 0649070903967 2x SDI Embedded Inputs - SD/HD/1080p/CC - Stereo & Multi-Ch Audio - Selectable Mpeg2 / H.264 Video - MpegL2 / AC3 / AAC / Dolby Pass

2CH - MPEG & DOLBY TRANSCODER OPTION



- SKU: 0649070904056 2 Channels MPEG TO MPEG transcoder & Scaler Card - Ideal to Change MPEG4 H264 Video to MPEG-2 Video and any audio to Dolby AC3 Audio.
- Each Card can transcode TWO simultaneous HD / SD TV Services changing to the wanted MPEG2 or H.264 HD/SD format as well to Mpeg1L2 or AAC or AC3 Dolby
- Dolby Digital Plus and any Multi-Channel / Multi-Language audio can be passed-through as-is.
- Downscaling from HD to any Lower Resolution is also supported

ULTRA-BT ASI-IP

ASI Over IP Advanced Gateway



The ULTRA-BT-ASI-IP Broadcast ASI over IP Router Intelligent Gateway Series is the Perfect, Flexible & **Most cost-effective solution** for any ASI over IP professional TV Services routing, distribution, destination remultiplexing, Bi-Directional redistribution over digital STL, LAN, WAN, Internet VPN, with Advanced integrated Stat-Mux Re-Multiplexer and broadcast-grade packets timing control.

Key Benefits

- Bi-Directional Real Time operation TX / RX
- Send selected Services to IP from the 4 ASI inputs
- Compatible to STL / LAN / WAN / VPN links
- Receives from 2 IP Networks up to 512 Streams
- Full Featured Stat-Mux Re-Multiplexing
- ASI Mux output - AS Original or Re-Muxed
- Can Aggregate different Feeds to ASI Mux out
- Transparent Mode operation - ASI over IP AS IS
- 5 Free Slots to add special options
- Redundant Dual Power Supply
- Simple Installation via Web Browser login



Key Facts

- Real-Time Bi-Directional Operation Send/Receive
- 4 ASI SPTS/MPTS Inputs or 2IN/2OUT via SW
- 2 IPTV Inputs –Outputs - 512 SPTS/MPTS I/O
- Stat Mux Re-Multiplexer to combine Services
- Complete DVB PSI-SI - LCN - Static EIT
- Complete ATSC PSIP - TVCT - Static EIT
- Network Connection to STL / LAN / WAN / VPN
- Packets Recovery & PCR Precision Control
- ASI Output - Original or Remuxed
- 2 IPTV outputs to Re-Route services to others
- Optional Tuners/Transcoders/Decoders Cards
- Dual Redundant Power Supply
- Made in USA - 5 Years of Warranty

Block Diagram

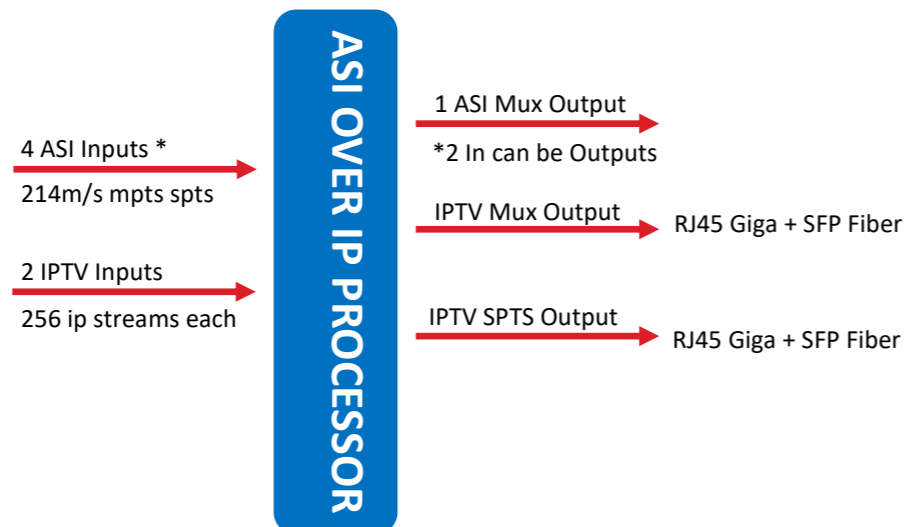

ULTRA-BT ASI-IP

ASI Over IP Advanced Gateway

Model Selector

ASI over IP Bi-Directional Gateway



SKU: 0649070906937 ULTRA-BT-ASI-IP - 2x RJ45 IPTV SPTS/MPTS In + 4x ASI SPTS/MPTS In + 1 ASI MUX Out + 2 IP SPTS & 2 IP MPTS RJ45/SFP Out - 5 Free Expansion

Plug-In Options

ASI I/O EXPANSION OPTION



- SKU: 0649070903868 4 ASI Ports SW Configurable each as Input or Output + 2x additional Gigabit Network Ports to Receive/Transmit MPTS/SPTS 512 IP Each

2 CH SD/HD SDI VIDEO DECODER OPTION



- SKU: 0649070903950 2 Channels 3GSDI Embedded Video Decoder Card (IRD) DECODES 2 SERVICES - MPEG2/4 + MPL2/AAC/AC3/PassThrough + CC

RF TUNER IN OPTION



- SKU: 0649070903998 4x ATSC 8VSB TUNER CARD - Receives up to 4 simultaneous COMPLETE TRANSPONDERS (all services) from 4 different ATSC Off Air Frequencies
- SKU: 0649070904018 4x ISDBT TUNER CARD - Receives up to 4 simultaneous COMPLETE TRANSPONDERS (all services) from 4 different ISDBT Off Air Frequencies
- SKU: 0649070904025 4x DVBT TUNER CARD - Receives up to 4 simultaneous COMPLETE TRANSPONDERS (all services) from 4 different DVBT Off Air Frequencies
- SKU: 0649070904025 4x QAM CABLE TUNER CARD - Receives up to 4 simultaneous COMPLETE TRANSPONDERS (all services) from 4 different QAM Frequencies

2CH - MPEG & DOLBY TRANSCODER OPTION



- SKU: 0649070904056 2 Channels MPEG TO MPEG transcoder & Scaler Card - Ideal to Change MPEG4 H264 Video to MPEG-2 Video and any audio to Dolby AC3 Audio.
- Each Card can transcode TWO simultaneous HD / SD TV Services changing to the wanted MPEG2 or H.264 HD/SD format as well to Mpeg1L2 or AAC or AC3 Dolby
- Dolby Digital Plus and any Multi-Channel / Multi-Language audio can be passed-through as-is.
- Downscaling from HD to any Lower Resolution is also supported

ULTRA-BT MUX

ASI & IP Re-Multiplexers



The ULTRA-BT-MUX Broadcast ASI & IP Stat-Mux Remultiplexer Series is the Perfect, Flexible & **Most cost-effective solution** for any ASI & IP SPTS MPTS Transport Stream Grooming, Restamping, Re-Multiplexing, with next-generation efficiency to manage Hi-Density of streams from/to ASI and IP Networks, supporting PSI & PSIP standard for any ATSC / QAM / ISDBT / DVBT / DVBC Transmission.

Key Benefits

- HI-Performance Stat-Mux Remultiplexer
- Manages SD / HD / 4K UHD TV Services
- Up to 1024 Streams per card MPTS/SPTS
- 4 Flexible ASI Ports configurable as In/Out
- 2 Gigabit IPTV RJ45 I/O Ports - 512 Streams Each
- 1 Fixed ASI Out port
- 1 SPTS / 1 MPTS Fiber + RJ45 outputs
- Simulcrypt CAS port Connects 5 CAS Servers
- 5 Free Slots to add special options
- Redundant Dual Power Supply
- Simple Control via Web Browser login



Key Facts

- 4 ASI I/O flex ports software configurable
- Can expand to 24 ASI I/O by adding cards
- 2 IPTV Inputs –Outputs - 512 SPTS/MPTS I/O
- Can expand to 12 IPTV ports by adding cards
- Complete DVB PSI-SI - LCN - Static EIT
- Complete ATSC PSIP - TVCT - Static EIT
- Network Connection to STL / LAN / WAN / VPN
- Packets Recovery & PCR Precision Control
- CAS Conditional Access Scrambling Ready
- 2 Fiber Optical SFP output port SPTS / MPTS
- Optional Tuners / Transcoders Cards
- Dual Redundant Power Supply
- Made in USA - 5 Years of Warranty

Block Diagram

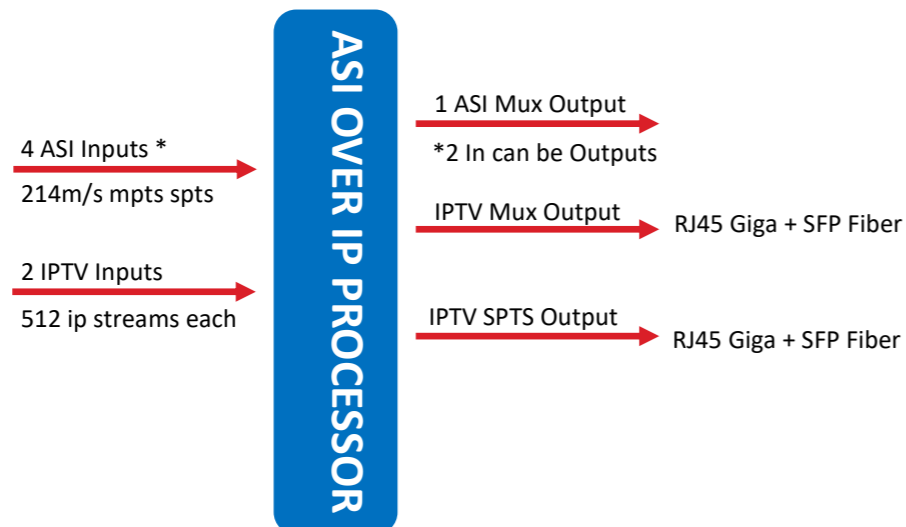

ULTRA-BT MUX

Model Selector

ASI & IP Re-Multiplexers

ASI & IP Stat-Mux Re-Multiplexer



SKU: 0649070906937 ULTRA-BT-ASI-IP - 2x RJ45 IPTV SPTS/MPTS In + 4x ASI SPTS/MPTS In + 1 ASI MUX Out + 2 IP SPTS & 2 IP MPTS RJ45/SFP Out - 5 Free Expansion

Plug-In Options

ASI I/O EXPANSION OPTION



- SKU: 0649070903868 4 ASI Ports SW Configurable each as Input or Output + 2x additional Gigabit Network Ports to Receive/Transmit MPTS/SPTS 512 IP Each

RF TUNER IN OPTION



- SKU: 0649070903998 4x ATSC 8VSB TUNER CARD - Receives up to 4 simultaneous COMPLETE TRANSPONDERS (all services) from 4 different ATSC Off Air Frequencies
- SKU: 0649070904018 4x ISDBT TUNER CARD - Receives up to 4 simultaneous COMPLETE TRANSPONDERS (all services) from 4 different ISDBT Off Air Frequencies
- SKU: 0649070904025 4x DVBT TUNER CARD - Receives up to 4 simultaneous COMPLETE TRANSPONDERS (all services) from 4 different DVBT Off Air Frequencies
- SKU: 0649070904025 4x QAM CABLE TUNER CARD - Receives up to 4 simultaneous COMPLETE TRANSPONDERS (all services) from 4 different QAM Frequencies

2CH - MPEG & DOLBY TRANSCODER OPTION



- SKU: 0649070904056 2 Channels MPEG TO MPEG transcoder & Scaler Card - Ideal to Change MPEG4 H264 Video to MPEG-2 Video and any audio to Dolby AC3 Audio.
- Each Card can transcode TWO simultaneous HD / SD TV Services changing to the wanted MPEG2 or H.264 HD/SD format as well to Mpeg1L2 or AAC or AC3 Dolby
- Dolby Digital Plus and any Multi-Channel / Multi-Language audio can be passed-through as-is.
- Downscaling from HD to any Lower Resolution is also supported

ASI IP RE-MULTIPLEXERS

ULTRA-BT IRD Receivers Decoders



The ULTRA-BT-IRD Broadcast Integrated Receiver Decoder Series is the Perfect, Flexible & **Most cost-effective solution** to receive and decode single or multiple channels of digital television SD/HD services with full broadcast video and sound quality, and flexible modularity on both input types and simultaneous services.

Key Benefits

- Modular Expandable IRD Receiver Decoder
- Up to 10 Simultaneous Channels Decoding
- Native Input from IP SPTS/MPTS and ASI
- OPTIONAL Tuners Cards & CAS modules
- BISS 0/1/E decryption per each decoder
- 3G-SDI output with Stereo or Pass-Through Audio
- MPEG2/H.264 SD/HD Video Decoding
- Mpeg / AAC / AC3 / Dolby audio
- Remultiplexer to Re-Stream to IP services
- ASI Mux Output
- Simple Control via Web Browser login

IRD DECODERS



Key Facts

- Can Receive from ASI or IP Inputs
- Mpeg2/H.264 CC L2/AC3/AAC/Dolby Pass AFD
- 2 Simultaneous HD/SD Broadcast Decoding
- Expandable to 10 Simultaneous Decoding
- ReMux Features to Re-Mux to ASI OUTs
- Complete PSI/PSIP management
- Network Connection to STL / LAN / WAN / VPN
- Can Re-Stream services to IP as MPTS or SPTS
- UP TO 1024 IP Streams I/O
- 2 Fiber Optical SFP output port SPTS / MPTS
- Optional Tuners / Transcoders Cards
- Dual Redundant Power Supply
- Made in USA - 5 Years of Warranty

Block Diagram

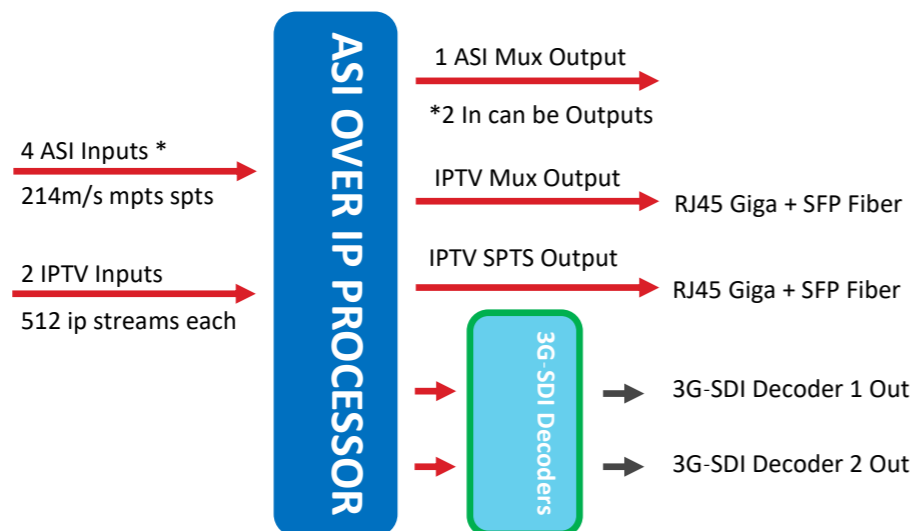

ULTRA-BT IRD Receivers Decoders Model Selector

Broadcast AFD IRD Dual Channel Decoder



SKU: 0649070906944 ULTRA-BT-IRD - 2x RJ45 IPTV SPTS/MPTS In + 4x ASI SPTS/MPTS In + 1 ASI MUX Out + 2 IP SPTS & 2 IP MPTS RJ45/SFP Out
2 Simultaneous 3G-SDI HD/SD Broadcast Video Decoders MPEG2/H.264 Video and Stereo Dolby AC3 AAC and pass-through multi channel audio - 4 Free Expansion

Plug-In Options

2 CH SD/HD SDI VIDEO DECODER OPTION



- SKU: 0649070903950 2 Channels 3GSDI Embedded Video Decoder Card (IRD) DECODES 2 SERVICES - MPEG2/4 + MPL2/AAC/AC3/PassThrough + CC

RF TUNER IN OPTION



- SKU: 0649070903998 4x ATSC 8VSB TUNER CARD - Receives up to 4 simultaneous COMPLETE TRANSPONDERS (all services) from 4 different ATSC Off Air Frequencies
- SKU: 0649070904018 4x ISDBT TUNER CARD - Receives up to 4 simultaneous COMPLETE TRANSPONDERS (all services) from 4 different ISDBT Off Air Frequencies
- SKU: 0649070904025 4x DVBT TUNER CARD - Receives up to 4 simultaneous COMPLETE TRANSPONDERS (all services) from 4 different DVBT Off Air Frequencies
- SKU: 0649070904025 4x QAM CABLE TUNER CARD - Receives up to 4 simultaneous COMPLETE TRANSPONDERS (all services) from 4 different QAM Frequencies

2CH - MPEG & DOLBY TRANSCODER OPTION



- SKU: 0649070904056 2 Channels MPEG TO MPEG transcoder & Scaler Card - Ideal to Change MPEG4 H264 Video to MPEG-2 Video and any audio to Dolby AC3 Audio.
- Each Card can transcode TWO simultaneous HD / SD TV Services changing to the wanted MPEG2 or H.264 HD/SD format as well to Mpeg1L2 or AAC or AC3 Dolby
- Dolby Digital Plus and any Multi-Channel / Multi-Language audio can be passed-through as-is.
- Downscaling from HD to any Lower Resolution is also supported

ULTRA-BT MODULAR HeadEnd Processor



The ULTRA-BT is a Modular Hi-Density Digital Television HeadEnd processor, Perfect, Flexible & **Most cost-effective solution** to manage route and Broadcast any SD/HD/4K digital Television service, over any existing IP and RF network, with the most advanced features and total reliability.

Key Benefits

- Hi-Density Broadcast Headend in 1RU Rack
- Combine Modules for unlimited features
- Connects to any RF and IP IN/OUT network
- Hot Swappable Cards for On-Site Maintenance
- 5 Year of Warranty—Total Reliability
- Compatible to ATSC/QAM /ISDBT/DVBT/DVBC
- Compatible to LAN/WAN/VPN/INTERNET
- Most advanced Video & Streams Control
- Simple Setup via Web Interface or SNMP
- Redundant Dual Power Supply
- Simple Installation via Web Browser login



Key Facts

- Main Chassis Includes the MAIN RE-Multiplexer
- Install Multi-Functional / Multi Channel Cards
- Tuners / Decoders / Encoders / Modulators
- Transcoders / CAS / Fiber IPTV / RJ45 IPTV / ASI
- Complete ATSC PSIP - TVCT - Static EIT
- Complete DVB PSI-SI - LCN - Static EIT
- MATRIX-Switch streams between cards & chassis
- Software set ATSC/QAM/DVBT/ISDBT/DVBC
- ASI Mux Output & IPTV output
- Dedicated WEB NMS SNMP Control port
- Multi-Gigabit capable stream switch
- Dual Redundant Power Supply
- Made in USA - 5 Years of Warranty



Block Diagram

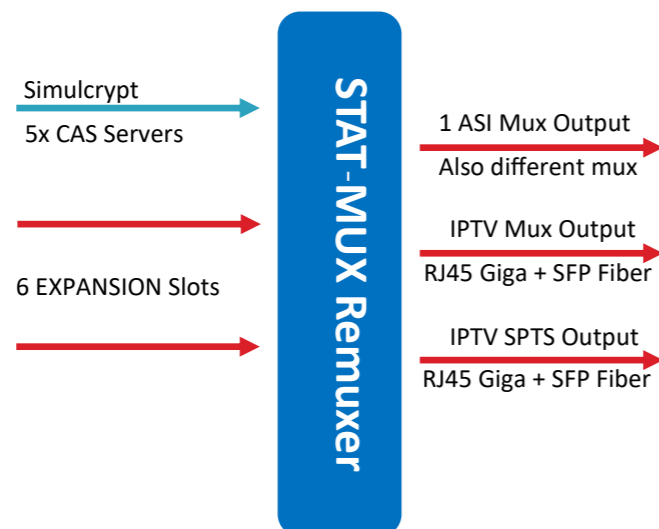

ULTRA-BT MODULAR HeadEnd Processor

Model Selector IP/ASI IN—Broadcast Transmission RF Modulator



SKU: 0649070906814 ULTRA-BT-CHASSIS 6x Hot-Swappable Multi-Channel Expansion Slots + Centralized Stat-Mux Re-Multiplexer + Dual Redundant Power Supply
1 ASI MUX Out + 1 IP 512 SPTS RJ45 + SFP Out + 1 IP 512 MPTS RJ45 + SFP Out + CAS Simulcrypt Conditional Access server port for 5 CAS Servers + NMS RJ45 port

Plug-In Options

RF TUNER IN OPTION



- SKU: 0649070903998 4x ATSC 8VSB TUNER CARD - Receives up to 4 simultaneous COMPLETE TRANSPONDERS (all services) from 4 different ATSC Off Air Frequencies
- SKU: 0649070904018 4x ISDBT TUNER CARD - Receives up to 4 simultaneous COMPLETE TRANSPONDERS (all services) from 4 different ISDBT Off Air Frequencies
- SKU: 0649070904025 4x DVBT TUNER CARD - Receives up to 4 simultaneous COMPLETE TRANSPONDERS (all services) from 4 different DVBT Off Air Frequencies
- SKU: 0649070904025 4x QAM CABLE TUNER CARD - Receives up to 4 simultaneous COMPLETE TRANSPONDERS (all services) from 4 different QAM Frequencies

VIDEO ENCODER OPTIONS



- SKU: 0649070903974 4x CVBS Composite via Cable Adaptor (included) 4:3 16:9 PAL/NTSC + CC - Selectable Mpeg2 / H.264 Video - Stereo MpegL2 / AC3 / AAC
- SKU: 0649070903844 4x Licensed HDMI Inputs - SD/HD/1080p - Stereo & Multi-Ch Audio—H.264 Video any Level/Profile - MpegL2 / AC3 / AAC / Dolby Pass Through
- SKU: 0649070903851 2x Licensed HDMI Inputs - SD/HD/1080p + CC - Stereo & Multi-Ch Audio - Selectable Mpeg2 / H.264 Video - MpegL2 / AC3 / AAC / Dolby Pass
- SKU: 0649070903967 2x SDI Embedded Inputs - SD/HD/1080p/CC - Stereo & Multi-Ch Audio - Selectable Mpeg2 / H.264 Video - MpegL2 / AC3 / AAC / Dolby Pass

2CH - MPEG & DOLBY TRANSCODER

- SKU: 0649070904056 2 Channels MPEG TO MPEG transcoder & Scaler Card - Ideal to Change MPEG4 H264 Video to MPEG-2 Video and any audio to Dolby AC3 Audio.
- Each Card can transcode TWO simultaneous HD / SD TV Services changing to the wanted MPEG2 or H.264 HD/SD format as well to Mpeg1L2 or AAC or AC3 Dolby
- Dolby Digital Plus and any Multi-Channel / Multi-Language audio can be passed-through as-is.
- Downscaling from HD to any Lower Resolution is also supported

2 CH SD/HD SDI VIDEO DECODER OPTION

- SKU: 0649070903950 2 Channels 3GSDI Embedded Video Decoder Card (IRD) DECODES 2 SERVICES - MPEG2/4 + MPL2/AAC/AC3/PassThrough + CC

ASI I/O MULTIPLEXER OPTION

- SKU: 0649070903868 4 ASI Ports SW Configurable each as Input or Output + 2x additional Gigabit Network Ports

RF MODULATOR OPTION

- SKU: 0649070906951 1 TO 16 CARRIERS - 16 Remuxers - 2x IPTV RJ45 In - 30-950Mhz Agile - 0dbm Adjustable level - sw load as ATSC QAM ISDBT DVBT DVBC DTMB
- SKU: 0649070906968 1 TO 32 CARRIERS QAM - 32 Remuxers - 2x IPTV RJ45 In - 30-950Mhz Agile - 0dbm Adj level - QAM J83B mode USA CABLE only
- SKU: 0649070903882 1 TO 16 CARRIERS - 16 Remuxers - 2x IPTV SFP In - 30-950Mhz Agile - 0dbm Adjustable level - sw load as ATSC QAM ISDBT DVBT DVBC DTMB

MODULAR HEADENDS

VIDEO DISTRIBUTION

Monitoring & Contribution

Video Over Coax

VeCOAX Minimod-2



- Licensed HDMI Input
- Real Time Encoding up to 1080P Full HD
- Output to RF Coax Direct to TV sets
- Scan & Find your channel on TVs
- Select ATSC/QAM/DVBT/DVBC/ISDBT
- SKU: 0649070909051

VeCOAX MICROMOD-3



- Licensed HDMI Input + CVBS + L/R Audio
- Real Time Encoding up to 1080P Full HD
- Output to RF Coax Direct to TV sets
- Scan & Find your channel on TVs
- Select ATSC/QAM/DVBT/DVBC/ISDBT
- SKU: 0649070909044

VeCOAX MICROMOD-3 SDI



- 3G SDI Embedded HDMI Input + CVBS
- Audio Embedded / HDMI / L-R RCA
- Real Time Encoding up to 1080P Full HD
- Output to RF Coax Direct to TV sets
- Scan & Find your channel on TVs
- Select ATSC/QAM/DVBT/DVBC/ISDBT
- SKU: 0649070906111

Rack Mount Options

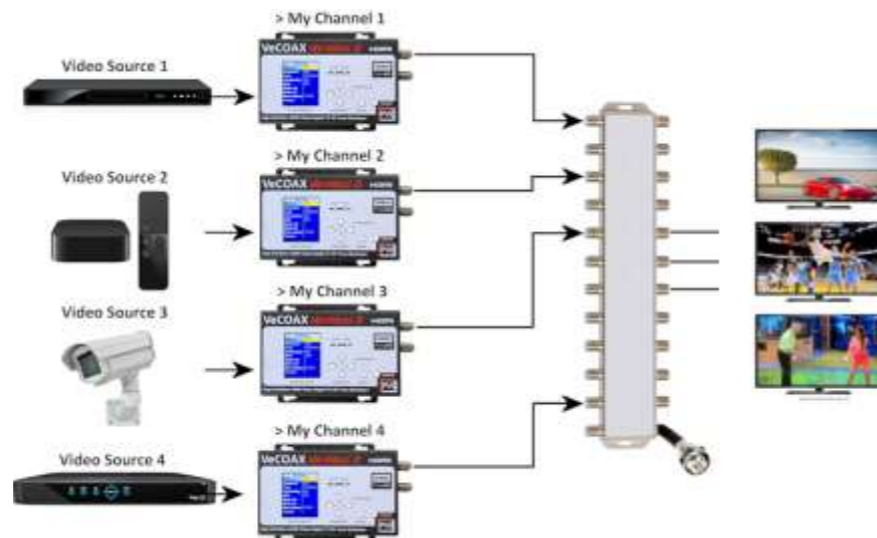

VIDEO DISTRIBUTION

Monitoring & Contribution

HD/4K Virtual Matrix Over IP

VuMATRIX 4K-60-4:4:4-POE



- HD/4K Video Over IP Real Time Distribution
- Works on existing Switches & Routers
- ZERO Configuration—Plug n Play
- Up to 99 Transmitters / Unlimited Receivers
- Can work over VPN & Internet between Locations
- Up to Full 4K 60 Frames 4:4:4 HDCP 2.2 HDMI 2.0
- Matrix Switch via Iphone / Ipad / Android / or API



HD/4K IPTV Streaming

VeCASTER 4K



- HD/4K Video Encoding & Streaming
- Direct Streaming to Lan, Wan Internet
- RTMP + M3U8 + RTSP + UDP + HLS + HTTP + ONIF
- 5 Logo Generators Inserters
- Multi-Rate: Simultaneous formats & scalers
- Modular, Add Unlimited Encoders anywhere
- Built In Gigabit Streaming Server
- Up to Full 4K 60 Frames 4:4:4 HDMI 2.0
- Super Ultra Low Delay—200ms in udp multicast
- Stream to YouTube / Facebook / Wowza etc.
- Receive DIRECT on Smart-TV via any IPTV Apps
- Receive directly on Iphones / Ipads / Android / VLC
- Rack Mountable via Rack Bars - 15 channels per kit
- SKU: 0649070905848



VIDEO DISTRIBUTION

VIDEO DISTRIBUTION

Monitoring & Contribution

Hi-Density Video Over Coax

VeCOAX-ULTRA



HDMI Over Coax Distribution

- Easy Installation - Perfect Full HD Quality
- Unlimited Televisions - Unlimited Channels
- Real Time - Any Distance - On Existing Coax

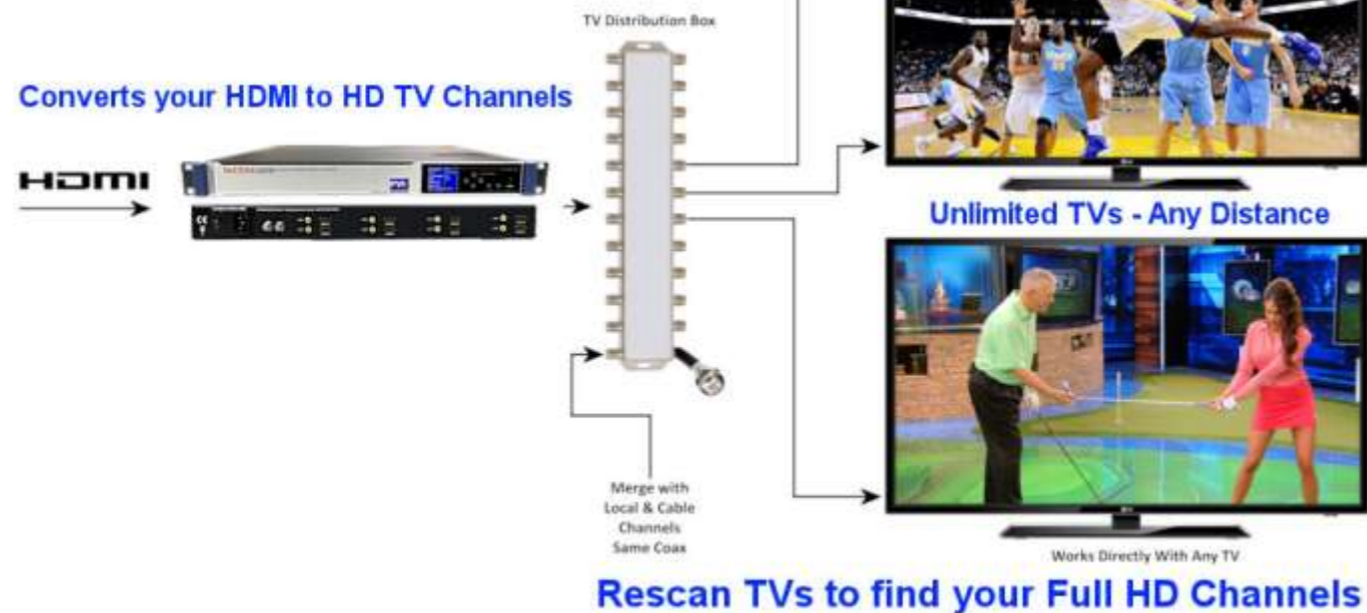

- SKU: 0649070907118 **VECOAX ULTRA-1-HDMI** 1x Licensed HDMI video input > 1x RF out selectable ATSC / QAM / ISDBT / DVBT / DVBC / DTMB
- SKU: 0649070904155 **VECOAX ULTRA-2-HDMI** 2x Licensed HDMI video inputs > 2x RF out selectable ATSC / QAM / ISDBT / DVBT / DVBC / DTMB
- SKU: 0649070903776 **VECOAX ULTRA-4-HDMI** 4x Licensed HDMI video inputs > 4x RF out selectable ATSC / QAM / ISDBT / DVBT / DVBC / DTMB
- SKU: 0649070903714 **VECOAX ULTRA-6-HDMI** 6x Licensed HDMI video inputs > 6x RF out selectable ATSC / QAM / ISDBT / DVBT / DVBC / DTMB
- SKU: 0649070903653 **VECOAX ULTRA-8-HDMI** 8x Licensed HDMI video inputs > 8x RF out selectable ATSC / QAM / ISDBT / DVBT / DVBC / DTMB

VIDEO DISTRIBUTION

Monitoring & Contribution

Hi-Density Video IPTV Streaming

VeCODER-ULTRA



SIMULTANEOUS M3U8 + HLS + RTMP + RTSP + RTP + HTTP + UDP

any IPTV APP

Any Format / Any Network
Anywhere

- SKU: 0649070905725 **VECODER-4-HDMI** 4x Licensed HDMI video inputs > SPTS RTMP + M3U8 + HLS + UDP + HTTP + RTP + RTSP + ONIF - Multi Rate - Logos
- SKU: 0649070905732 **VECODER-8-HDMI** 8x Licensed HDMI video inputs > SPTS RTMP + M3U8 + HLS + UDP + HTTP + RTP + RTSP + ONIF - Multi Rate - Logos
- SKU: 0649070905749 **VECODER-12-HDMI** 12x Licensed HDMI video inputs > SPTS RTMP + M3U8 + HLS + UDP + HTTP + RTP + RTSP + ONIF - Multi Rate - Logos
- SKU: 0649070905756 **VECODER-16-HDMI** 16x Licensed HDMI video inputs > SPTS RTMP + M3U8 + HLS + UDP + HTTP + RTP + RTSP + ONIF - Multi Rate - Logos



VIDEO DISTRIBUTION