

CP 3072



User Manual

- Manual #: RGB-RD-UM-CP3072 E001
- Revision: V1.1
- This User Manual Applies to CP 3072 and CP 3072S!



CP 3072-User Manual

Thank you for choosing our products!

In order to allow you to learn how to use the video processor quickly, we bring you the detailed user manual. You can read the introduction and directions before using the video processor, please read all the information we provide carefully to use our products correctly.

Copyright

©2012 All rights are reserved by RGBlink.

This document is done independently by Xiamen RGBlink Science & Technology Co.,LTD. No part can be copied, reproduced or translated without permission.

Notice

RGBlink provides this manual “as is” without warranty of any kind, no matter expressed or implied, including but not limited to the implied warranties or merchantability and fitness for a particular purpose. RGBlink may make improvements or changes to the products and the programs described in this publication at any time without notice.

This publication would contain technical inaccuracies or typographical errors. Changes are periodically made to the information in this publication; these changes are incorporated in new editions of this publication.

Federal Communications Commission

(FCC) Statement

This equipment has been tested and found to comply with the limits for a class A digital device, pursuant to Part 15 of the FCC rules. These limits are designed to provide reasonable protection against harmful interference when the equipment is operated in a commercial environment. This equipment generates, uses and radiates radio frequency energy and, if not installed or used in accordance with the instruction manual, may cause harmful interference to radio communications. Operation of this equipment in a residential area may cause harmful interference, in which case the user will be responsible for correcting any interference.

Guarantee and Compensation

RGBlink provides a guarantee related to perfect manufacturing as part of the legally stipulated terms of guarantee. On receipt, the purchaser must immediately inspect all delivered goods for damage incurred during transportation, as well as for material and manufacturing faults. Please complain to RGBlink by written notice.

The period of guarantee begins from the date of transfer of risks, in the case of special systems and software on the date of commissioning, at latest 30 days after the transfer of risks. In the event of justified notice of compliant, RGBlink can repair the fault or provide a replacement at its own discretion within an appropriate period. If this measure proves to be impossible or unsuccessful, the purchaser can demand a reduction in the purchase price or cancellation of the contract. All other claims, in particular those relating to compensation for direct or indirect damage, and also damage attributed to the operation of software as well as to other service provided by RGBlink, being a component of the system or independent service, will be deemed invalid provided the damage is not proven to be attributed to the absence of properties guaranteed in writing or due to the intent or gross negligence or part of RGBlink.

If the purchaser or a third party carries out modifications or repairs on goods delivered by RGBlink, or if the goods are handled incorrectly, in particular if the systems are commissioned operated incorrectly or if, after the transfer of risks, the goods are subject to influences not agreed upon in the contract, all guarantee claims of the purchaser will be rendered invalid. Not included in the guarantee coverage are system failures which are attributed to programs or special electronic circuitry provided by the purchaser, e.g. interfaces. Normal wear as well as normal maintenance are not subject to the guarantee provided by RGBlink either.

The environmental conditions as well as the servicing and maintenance regulations specified in this manual must be complied with the customer.

Trademark

Brand and product names mentioned in this manual may be trademarks, registered trademarks or copyrights of their respective holders. All brand and product names mentioned in this manual serve as comments or examples and are not to be understood as advertising for the products or their manufactures.

Company Address



Xiamen RGBlink Science & Technology Co., Ltd.

Headquarter: S603~604 Weiye Building Torch Hi-Tech Industrial Development Zone Xiamen, Fujian Province, P.R.C

Shenzhen office: Floor 11, A1 Building, Baiwang R&D Building, Shahe West Road, Xili Town, Nanshan District, Shenzhen, Guangdong Province, P.R.C

Beijing office: No. 2702, Sino-Light Building Tower B, Wang-Jing East Road, Chaoyang District, Beijing, P.R.C

Shanghai office: East Building F2, No. 88 Qinjiang Road, Shanghai, P.R.C

- **Tel:** +86-592-5771197
- **Fax:** +86-592-5771202
- **Customer Hotline:** 4008-592-315
- **Websites:**
 - ~ <http://www.rgblink.com>
 - ~ <http://www.rgblink.cn>
- **E-mail:** sales@rgblink.com

Operators Safety Summary

The general safety information in this summary is for operating personnel.

Do Not Remove Covers or Panels

There are no user-serviceable parts within the unit. Removal of the top cover will expose dangerous voltages. To avoid personal injury, do not remove the top cover. Do not operate the unit without the cover installed.

Power Source

This product is intended to operate from a power source that will not apply more than 230 volts rms between the supply conductors or between both supply conductor and ground. A protective ground connection by way of grounding conductor in the power cord is essential for safe operation.

Grounding the Product

This product is grounded through the grounding conductor of the power cord. To avoid electrical shock, plug the power cord into a properly wired receptacle before connecting to the product input or output terminals. A protective-ground connection by way of the grounding conductor in the power cord is essential for safe operation.

Use the Proper Power Cord

Use only the power cord and connector specified for your product. Use only a power cord that is in good condition. Refer cord and connector changes to qualified service personnel.

Use the Proper Fuse

To avoid fire hazard, use only the fuse having identical type, voltage rating, and current rating characteristics. Refer fuse replacement to qualified service personnel.

Do Not Operate in Explosive

Atmospheres

To avoid explosion, do not operate this product in an explosive atmosphere.

Terms in This Manual and Equipment Marking



WARNING

Highlight an operating procedure, practice, condition, statement, etc, which, if not strictly observed, could result in injury or death of personnel.

Note

Highlights an essential operating procedure, condition or statement.
--



CAUTION

The exclamation point within an equilateral triangle is intended to alert the user to the presence of important operating and maintenance (servicing) instructions in the literature accompanying the appliance.

Amendment Records

The table below lists the changes to the Video Processor User Manual.

Format	Time	ECO#	Description	Principal
V1.0	2015-03-30	0000#	Release	Vira
V1.1	2015-06-01	0001#	1. Add SDI input module. 2. Update the menu. 3. Update the common questions. 4. Add "Solution for weak damping effects of T-bar".	Vira

CONTENT



CONTENT	8
1. Brief Introduction.....	13
Chapter Structure	14
How to Use the Manual	15
Term and Definitions	16
System Overview	20
Application Questions	21
2. Hardware Orientation	22
In This Chapter	22
CP 3072 Back Panel.....	23
CONT Interface	23
19: Dial Switch.....	23
20: USB Interface.....	24
21. 22: RS-232 Interface.....	24
INPUT Interface.....	24
23. 25: Audio Input.....	24
1. 5. 9. 13: USB Input	24
2. 6. 10. 14: CVBS Input	25
3. 7. 11. 15: HDMI/3G-SDI Input.....	25
4. 8. 12. 16: VGA Input.....	25

OUTPUT Interface	25
27: HDMI Program Output.....	25
29: VGA Program Output.....	25
31: CVBS Program Output.....	25
26: HDMI Preview Output.....	25
28: VGA Preview Output.....	25
30: HDMI PVW Output.....	26
Switch and Power	26
17. 18: Switch and Power.....	26
TALLY Light.....	26
24: TALLY Light	26
CP 3072 Front Panel	27
PVW Out Area	28
Save/Load Area.....	29
Function Edit Area.....	30
Input Source Edit Area	31
DSK, BLEND and PIP Area.....	33
Effects Operation Area	34
Output Format Setting Area	35
Lock Top Panel Area.....	35
Transition Time Control Area.....	36
T-bar Control Area.....	36

Auto Switch Button	36
3. Hardware Installation	37
In This Chapter	37
Safety Precautions	38
Unpacking and Inspection.....	38
Site Preparation.....	38
4. Menu Orientation	39
In This Chapter	39
MENU	40
INPUT	40
OUTPUT.....	41
SYSTEM.....	42
LANGUAGE	43
FACTORY RESET	43
5. System Setup and Operations.....	44
In This Chapter	44
Interface and Input Signal Option.....	45
How to Change the Transition Effects.....	47
How to Choose the Output Format	48
How to Edit the Channel Signal.....	49
How to Realize Single Image Switching.....	50

How to Scale the Image	51
How to Crop the Image.....	52
How to Set the Position of the Image	53
How to Set up the PIP	54
How to Use Black Out.....	55
How to Realize the BLEND Setting.....	56
How to Realize the DSK Setting.....	57
How to Save the Parameter.....	58
How to Load the Saved Parameter.....	59
6. Common Questions and Solutions	60
In This Chapter	60
The USB doesn't Play Video Well	61
Confirm if There are Multiple Videos in USB Root Directory	61
Confirm If There is Signal Output.....	61
Flash Point in LED Display Output.....	61
Confirm If Monitor Output is Normal	61
The HDMI Input Signal of Blu-ray DVD cannot be Shown	61
Choose HDMI Signal as HDMI Input	61
No Sound Output from Output Port.....	62
Confirm if the DVI Mode of PGM Output is HDMI	62
VGA Input Offset or cannot be Full Size Shown.....	62
Set Auto Adjust for VGA Input.....	62

A. Specification	63
B. Contact Information.....	66
C. Software Upgrade.....	67
D. Solution for Weak Damping Effects of T-bar	72

1. Brief Introduction

This chapter is designed to introduce you to the CP 3072 User Manual.

Areas to be covered are:

- Chapter Structure
- How to Use the Manual
- Terms and Definitions
- System Overview
- Application Questions

1. Brief Introduction

Chapter Structure

Chapter Structure

The following chapters provide instructions for all aspects of CP 3072 operations.

Chapter 1 [Brief Introduction](#)

Chapter 2 [Hardware Orientation](#)

Chapter 3 [Hardware Installation](#)

Chapter 4 [Menu Orientation](#)

Chapter 5 [System Setup and Operations](#)

Chapter 6 [Common Questions and Solution](#)

Appendix A [Specification](#)

Appendix B [Contact Information](#)

Appendix C [Software Upgrade](#)

Appendix D [Solution for Weak Damping Effects of T-bar](#)

1. Brief Introduction

How to Use the Manual

How to Use the Manual

Followings are important tips for streamlining your use of this User's Manual in its electronic "PDF" form.

Navigation

Use Acrobat Reader's "bookmarks" to navigate to the desired location. All chapter files have the same bookmark structure for instant navigation to any section. Please note:



- Extensive hyperlinks are provided within the chapters.
- Use Acrobat's "**Go to Previous View**" and "**Return to next View**" buttons to trace your complete navigational path.



- Use the "**Previous Page**" and "**Next Page**" buttons to go to the previous or next page within a file.
- Use Acrobat's extensive search capabilities, such as the "**Find**" tool and "**Search Index**" tool to perform comprehensive searches as required.

Table of Contents and Index

Use the Table of Contents bookmarks to navigate a desired topic. Click any item to instantly jump to that section of the guide. You can also use the **Index** to jump to specific topics within a chapter. Each page number in the **Index** is a hyperlink.

General Operations

To ensure trouble-free operation, please follow all procedures as listed below:

- For detailed installation instructions, refer to chapter 3 "Hardware Installation" on page 37.
- For system setup and operations, refer to Chapter 5, "System Setup and Operations" on page 44.

Should you have any questions regarding the installation or operation of CP 3072, please consult with the factory. Refer to Appendix B on page 66 for contact information.

1. Brief Introduction

Terms and Definitions

Term and Definitions

The following terms and definitions are used throughout this guide.

- **“Aspect ratio”**: The relationship of the horizontal dimension to the vertical dimension of an image. In viewing screens, standard TV is 4:3, or 1.33:1; HDTV is 16:9, or 1.78:1. Sometimes the “:1” is implicit, making TV = 1.33 and HDTV = 1.78.
- **“AV”**: Audio visual or audio video.
- **“Baudrate”**: Named of J.M.E. Baudot, the inventor of the Baudot telegraph code. The number of the electrical oscillations per second, called baud rate. Related to, but not the same as, transfer rate in bits per second (bps).
- **“BNC”**: Bayonet Neill-Concelman. A cable connector used extensively in television and named for its inventors. A cylindrical bayonet connector that operates with a twist-locking motion. To make the connection, align the two curved grooves in the collar of the male connector with the two projections on the outside of the female collar, push, and twist. This allows the connector to lock into place without tools.
- **“Brightness”**: Usually refers to the amount or intensity of video light produced on a screen without regard to color. Sometimes called “black level.”
- **“Color bars”**: A standard test pattern of several basic colors (white, yellow, cyan, green, magenta, red, blue, and black) as a reference for system alignment and testing. In NTSC video, the most commonly.
- **“DVI”**: Digital Visual Interface. The digital video connectivity standard that was developed by DDWG (Digital Display Work Group). This connection standard offers two different connectors: one with 24 pins that handles digital video signals only, and one with 29 pins that handles both digital and analog video.
- **“EDID”**: Extended Display Identification Data – EDID is a data structure used to communicate video display information, including native resolution and vertical interval refresh rate requirements, to a source device. The source device will then output the optimal video format for the display based on the provided EDID data, ensuring proper video

1. Brief Introduction

Terms and Definitions

image quality. This communication takes place over the DDC – Display Data Channel.

- **“Frame”**: In interlaced video, a frame is one complete picture. A video frame is made up of two fields, or two sets of interlaced lines. In a film, a frame is one still picture of a series that makes up a motion picture.
- **“HDMI” - High – Definition Multimedia Interface**: An interface used primarily in consumer electronics for the transmission of uncompressed high definition video, up to 8 channels of audio, and control signals, over a single cable. HDMI is the de facto standard for HDTV displays, Blu-ray Disc players, and other HDTV electronics. Introduced in 2003, the HDMI specification has gone through several revisions.
- **“HDSDI”**: The high-definition version of SDI specified in SMPTE-292M. This signal standard transmits audio and video with 10 bit depth and 4:2:2 color quantization over a single coaxial cable with a data rate of 1.485 Gbit/second. Multiple video resolutions exist including progressive 1280x720 and interlaced 1920x1080 resolutions. Up to 32 audio signals are carried in the ancillary data.
- **“JPEG” (Joint photographic Expects Group)**: Commonly used method of loss compression for photographic images using a discreet cosine transfer function. The degree of compression can be adjusted, allowing a selectable tradeoff between storage size and image quality. JPEG typically achieves 10:1 compression with little perceptible loss in image quality. Produces blocking artifacts.
- **“MPEG”**: Motion Picture Expect Group. A standard committee under the auspices of the International Standards Organization working on algorithm standards that allows digital compression, storage and transmission of moving image information such as motion video, CD-quality audio, and control data at CD-ROM bandwidth. The MPEG algorithm provides inter-frame compression of video images and can have an effective compression rate of 100:1 to 200:1.
- **“NTSC”**: The color video standard used in North America and some other parts of the world created by the National Television Standards Committee in the 1950s. A color signal must be compatible with black-and-white TV sets. NTSC utilizes an interlaced video signals, 525 lines of resolution with a refresh rate of 60 fields per second (60 Hz). Each frame is comprised of two fields of 262.5 lines each, running at an effective rate of 30 frames per second.

1. Brief Introduction

Terms and Definitions

- **“PAL”**: Phase Alternate Line. A television standard in which the phase of the color carrier is alternated from line to line. It takes four full pictures (8 fields) for the color-to-horizontal phase relationship to return to the reference point. This alternation helps cancel out phase errors. For this reason, the hue control is not needed on a PAL TV set. PAL, in many transmission forms, is widely used in Western Europe, Australia, Africa, the Middle East, and Micronesia. PAL uses 625-line, 50-field (25 fps) composite color transmission system.
- **“Operator”**: Refers to the person who uses the system.
- **“PIP”**: Picture-in-Picture. A small picture within a larger picture created by scaling down one of the images to make it smaller. Each picture requires a separate video source such as a camera, VCR, or computer. Other forms of PIP displays include Picture-by-Picture (PBP) and Picture-with-Picture (PWP), which are commonly used with 16:9 aspect display devices. PBP and PWP image formats require a separate scaler for each video window.
- **“Polarity”**: The positive and negative orientation of a signal. Polarity usually refers to the direction or a level with respect to a reference (e.g. positive sync polarity means that sync occurs when the signal is going in the positive direction).
- **“RS-232”**: An Electronic Industries Association (EIA) serial digital interface standard specifying the characteristics of the communication path between two devices using either DB-9 or DB-25 connectors. This standard is used for relatively short-range communication and does not specify balanced control lines. RS-232 is a serial control standard with a set number of conductors, data rate, word length, and type of connector to be used. The standard specifies component connection standards with regard to the computer interface. It is also called RS-232-C, which is the third version of the RS-232 standard, and is functionally identical to the CCITT V.24 standard.
- **“Scaling”**: A conversion of a video or computer graphic signal from a starting resolution to a new resolution. Scaling from one resolution to another is typically done to optimize the signal for input to an image processor, transmission path or to improve its quality when presented on a particular display.
- **“SDI”**: Serial Digital Interface. The standard based on a 270 Mbps

1. Brief Introduction

Terms and Definitions

transfer rate. This is a 10-bit, scrambled, polarity independent interface with common scrambling for both component ITU-R 601 and composite digital video and four channels of (embedded) digital audio.

- **“Seamless Switching”**: A feature found on many video switchers. This feature causes the switcher to wait until the vertical interval to switch. This avoids a glitch (temporary scrambling) which normally is seen when switching between sources.
- **“SMPTE”**: Society of Motion Picture and Television Engineers. A global organization, based in the United States that sets standards for base band visual communications. This includes film as well as video and television standards.
- **“USB”**: Universal Serial Bus. USB was developed by seven PC and telecom industry leaders (Compaq, DEC, IBM, Intel, Microsoft, NEC, and Northern Telecom). The goal was easy plug-and-play expansion outside the box, requiring no additional circuit cards. Up to 127 external computer devices may be added through a USB hub, which may be conveniently located in a keyboard or monitor. USB devices can be attached or detached without removing computer power. The number of devices being designed for USB continues to grow, from keyboards, mice, and printers to scanners, digital cameras, and ZIP drives.
- **“VESA”**: Video Electronics Standards Association. A nonprofit number organization dedicated to facilitating and promoting personal computer graphics through improved standards for the benefit of the end-user. www.vesa.org
- **“VGA”**: Video Graphics Array. Introduced by IBM in 1987, VGA is an analog signal with TTL level separate horizontal and vertical sync. The video outputs to a 15-pin HD connector and has a horizontal scan frequency of 31.5 kHz and vertical frequency of 70 Hz (Mode 1, 2) and 60 Hz (Mode 3). The signal is non-interlaced in modes 1, 2, and 3 and interlaced when using the 8514/A card (35.5 kHz, 86 Hz) in mode 4. It has a pixel by line resolution of 640×480 with a color palette of 16 bits and 256,000 colors.

1. Brief Introduction

System Overview

System Overview

CP 3072 is a multiviewer and presentation mixer with multi-layers preview function that support analog and digital video graphics to be mixed together and seamlessly switched to program outputs. User can realize the switching effects by using the interactive control panel, including the buttons, knobs, T-BAR, slider control, OLED panel, the indicator light etc. The CP 3072 supports the multi-layers preview, preview edit, and realize the audio and video sync control. Quick function control and professional appearance make CP 3072 the preferred introductory proAV switcher for application including stage performance, broadcasting and TV.

1. Brief Introduction

Application Questions

Application Questions

RGBlink offers solutions to demand technical problems. Any application questions, or required further information, please contact with our Customer Support Engineers. Refer to Appendix B for contact details.

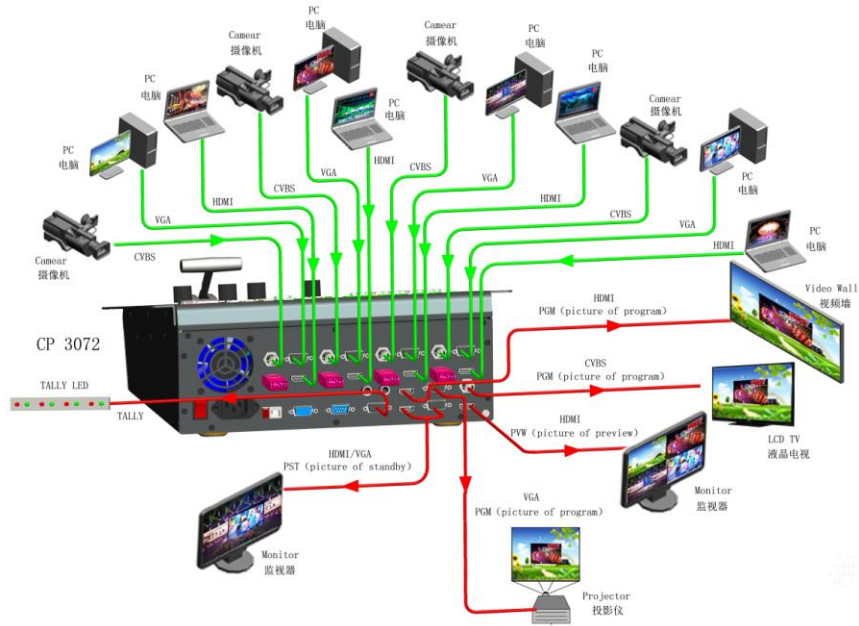

(CP 3072 System Connection Diagram)

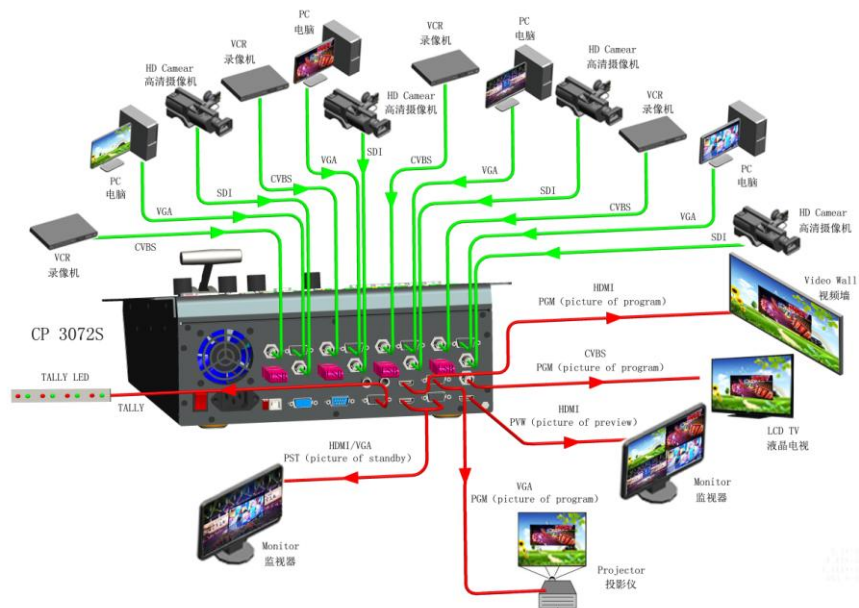

(CP 3072S System Connection Diagram)

2. Hardware Orientation



In This Chapter

This chapter provides detailed information about the CP 3072 hardware.
The following topics are discussed:

- [CP 3072 Back Panel](#)
- [CP 3072 Front Panel](#)

2. Hardware Orientation

CP 3072 Back Panel

CP 3072 Back Panel

The figure below illustrates the professional interface and control signals of CP 3072 back panel.

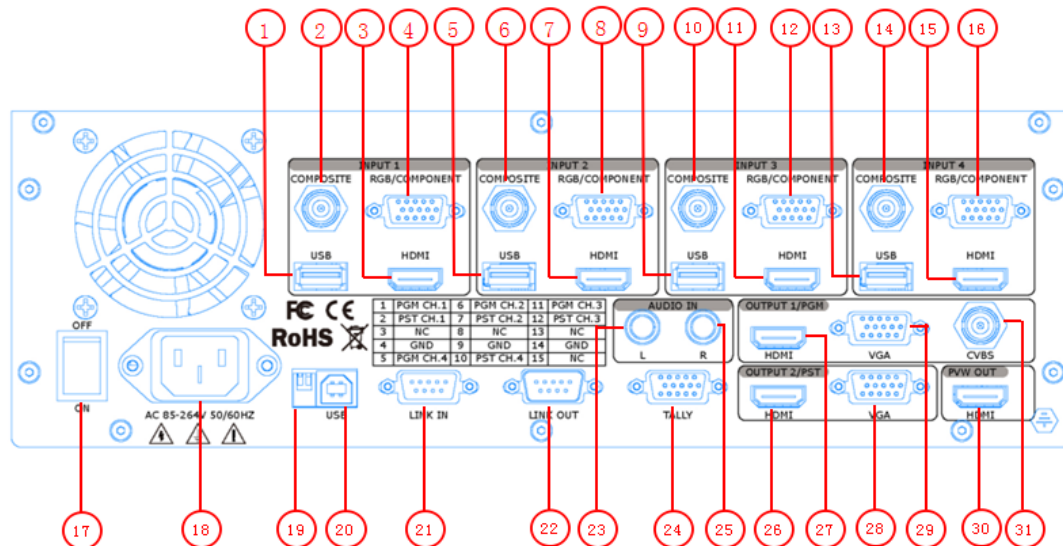

NO	INTERFACE	NO	INTERFACE
1. 5. 9. 13	USB input USB-B port	23. 25	Audio input port
2. 6. 10. 14	CVBS input BNC port	24	TALLY light
3. 7. 11. 15	HDMI/3G-SDI input	27	HDMI program output HDMI-A port
4. 8. 12. 16	VGA input DB15 port	29	VGA program output DB15 port
17	Switch	31	CVBS program output BNC port
18	Power IEC-3	26	HDMI preview output HDMI-A port
19	Dial Switch	28	VGA preview output DB15 port
20	USB Interface	30	HDMI PVW output HDMI-A port
21. 22	RS-232 Interface		

CONT Interface

19: Dial Switch

If the two dial switches are downwards, the device is in normal work, and if they are upwards, the device is in upgrade state. OLED module light is

2. Hardware Orientation

CP 3072 Back Panel

off when the device is in upgrade state. Some of the button lights turn on, and the device will not work.

20: USB Interface

Used for firmware upgrade.

21. 22: RS-232 Interface

Used for cascade and firmware upgrade.

21: LINK IN is serial male port.

22: LINK OUT is serial female port.

LINK IN is the serial communication interface of RS-232 control protocol and multiple cascading control.

LINK OUT is the serial communication interface of multiple devices cascading control, connect devices through DB9 serial cable.

Note

CP 3072 V1.1 cannot support this function.

INPUT Interface

It includes 4 CVBS inputs by BNC port, 4 USB inputs, 4 HDMI inputs (only for CP 3072), 4 3G-SDI inputs (only for CP 3072S), 4 VGA inputs by DB15 port, and 1 group of Audio L and Audio R input.

23. 25: Audio Input

Audio input, connect the audio signals of the DVD player, hardware player and digital box.

1. 5. 9. 13: USB Input

USB input, can access the USB device or mobile hard disk with USB storage function. Support general image and video formats.

Note

CP 3072 V1.1 can only support video formats.

2. Hardware Orientation

CP 3072 Back Panel

2. 6. 10. 14: CVBS Input

CVBS input, input standard video signal from players, cameras etc. Support resolution 480i and 576i via BNC. Support standards include: PAL and NTSC.

3. 7. 11. 15: HDMI/3G-SDI Input

HDMI input, input the image signal from computer.

3G-SDI input, input video signal from HD camera and radio processing equipment, connect SDI interface via 75 ohms impedance BNC port.

4. 8. 12. 16: VGA Input

VGA input, input the video signal from HD player and Computer, etc. Compatible with YPbPr signal, input signal via the DB15 interface.

OUTPUT Interface

27: HDMI Program Output

HDMI output interface, used to connect to the display device, video processor or matrix.

29: VGA Program Output

Connect to the monitor or LED display which has VGA interface.

(This VGA connector does not support hot-plugging)

31: CVBS Program Output

CVBS can output PAL and NTSC, output signal can access to TV, and the device with CVBS input. Can choose aspect ratio 4:3 or 16:9.

26: HDMI Preview Output

HDMI output interface, used to connect to the display device, video processor or matrix.

28: VGA Preview Output

2. Hardware Orientation

CP 3072 Back Panel

Connect to the monitor or LED display which has VGA interface.

(This VGA connector does not support hot-plugging)

30: HDMI PVW Output

HDMI output interface, used to connect to the display device, video processor or matrix.

Switch and Power

17. 18: Switch and Power

AC 85-264V, 50/60Hz, IEC-3 Power Interface.

TALLY Light

24: TALLY Light

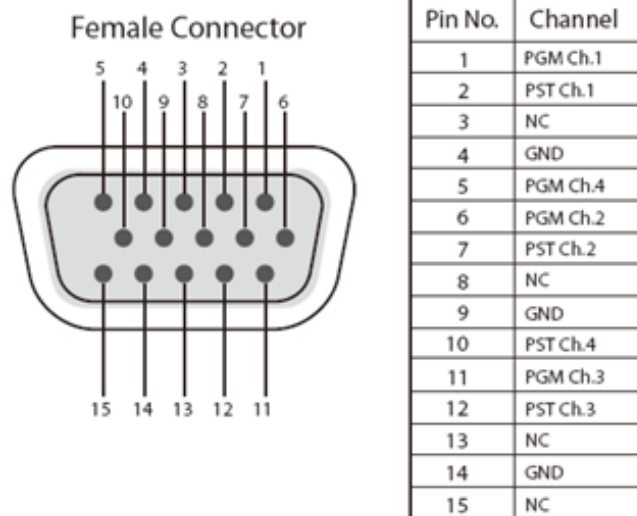

2. Hardware Orientation

CP 3072 Front Panel

CP 3072 Front Panel

Plug into the power cord, OLED panel on the front panel will show RGBlink and go into self verification before it load last setting and send processed image to the target monitor. For the first setup, HDMI input is default source. With front panel keyboard, user can operate CP 3072 through the menus on OLED panel. CP 3072 front panel as shown in figure:

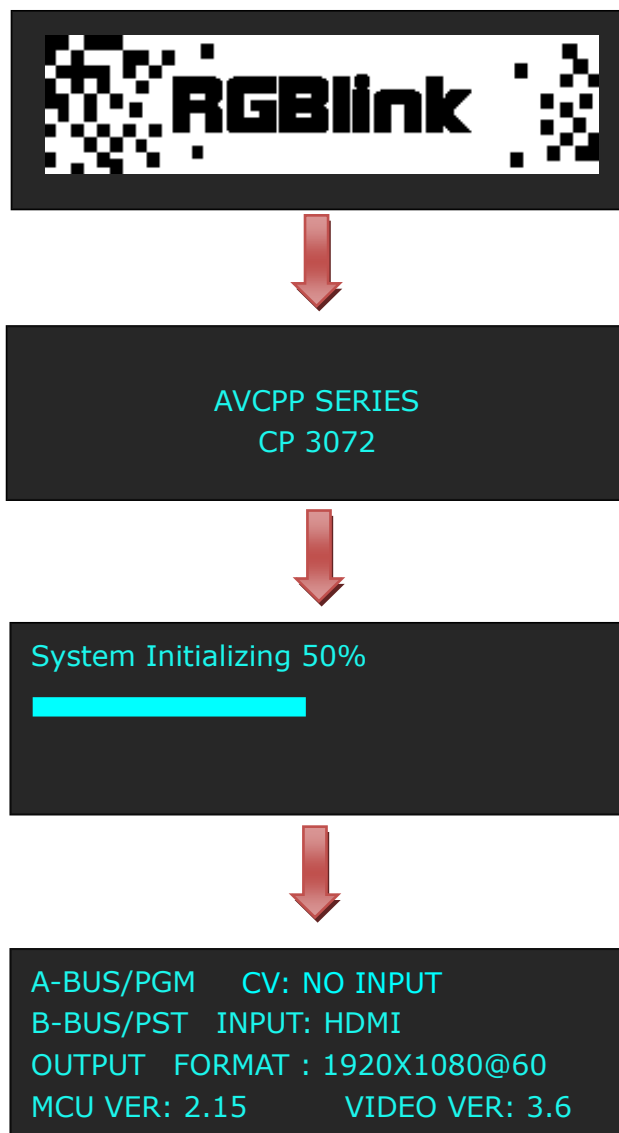

2. Hardware Orientation

CP 3072 Front Panel

CP 3072 front panel is as following:

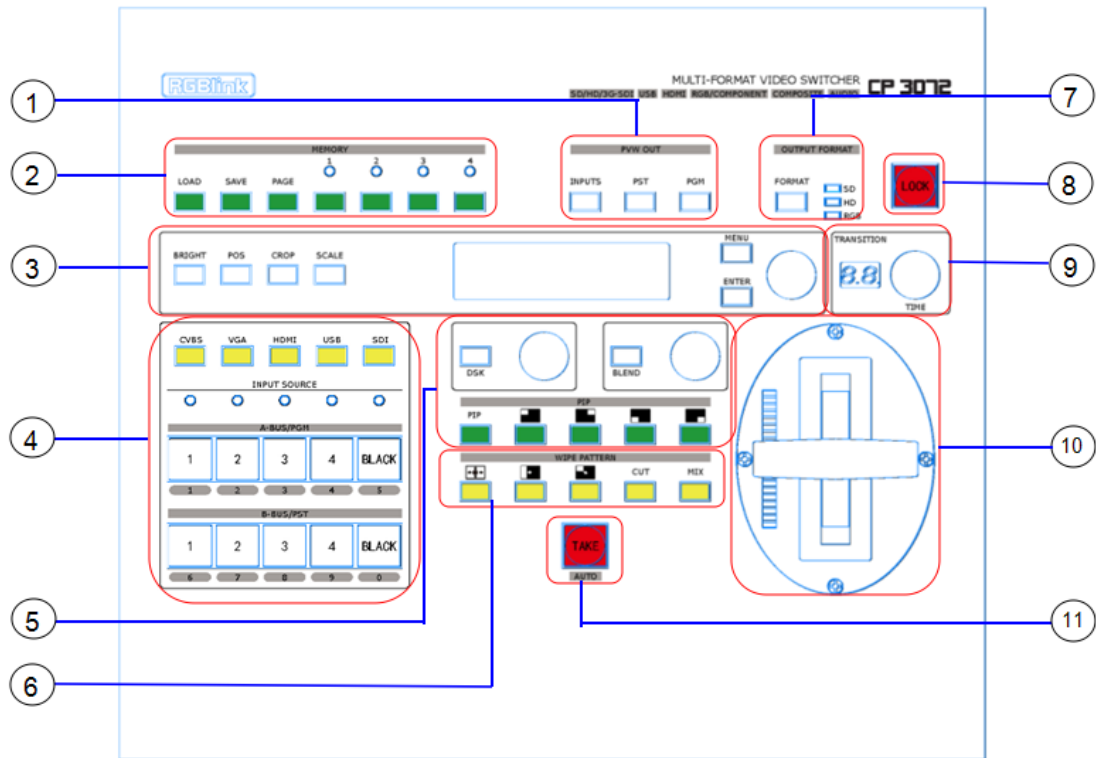

Panel Instruction			
1	PVW out area	7	Output format setting area
2	Save/Load area	8	Lock top panel area
3	Function edit area	9	Transition time control area
4	Input sources edit area	10	T-bar control area
5	DSK, BLEND and PIP area	11	Auto take button
6	Effects operation area		

PVW Out Area

PVW OUT

INPUTS PST PGM

INPUTS
 4 layers preview signal, push the button, the button light is on, and PVW out will be switched to this channel.

PST
 Preview edit signal, push the button, the button light is on, and PVW out will be switched to this channel.

2. Hardware Orientation

CP 3072 Front Panel

 PGM Program output signal, push the button, the button light is on, and PVW out will be switched to this channel.

Save/Load Area

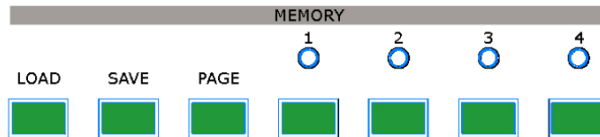

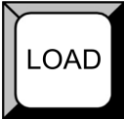
 Load button, push the button, and combined with PAGE button to load the saving parameters, users can load data from SAVE1 or SAVE16.

 Save button: push the button, and combined with PAGE button to save the current parameters to SAVE 1 to SAVE 16.

 PAGE button, use for save the parameters or load the saved parameters, total for 4 pages, and each page with 4 banks.

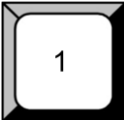
 Number button 1, use for save or load.

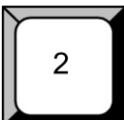
 Number button 2, use for save or load.

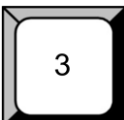
 Number button 3, use for save or load.

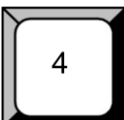
 Number button 4, use for save or load.

2. Hardware Orientation

CP 3072 Front Panel

Function Edit Area



OLED Panel, used for show button menu and menus for interactive communication.

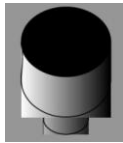

Knob, used to adjust OLED menu and information interaction and with the same function with enter to confirm current options.



Menu button, push the button to enter the menu items. Turn the knob to select the relevant submenu.

For details, please refer to [MENU](#) in menu orientation.



Confirm button.



Push the button and turn the knob to adjust the brightness, the adjustment range is 0~100.



Position adjustment button, push the button, the button light is on, turn the knob to adjust the position of the image.

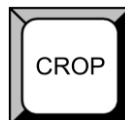

Crop button, push the button, the button light is on, turn the knob to crop the size and position of the image.

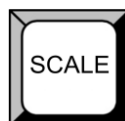

Scale button. Push the button for scale control. Turn the knob, user can change the size of the image. It is mainly used for LED display.

2. Hardware Orientation

CP 3072 Front Panel

Input Source Edit Area

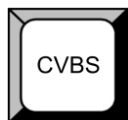
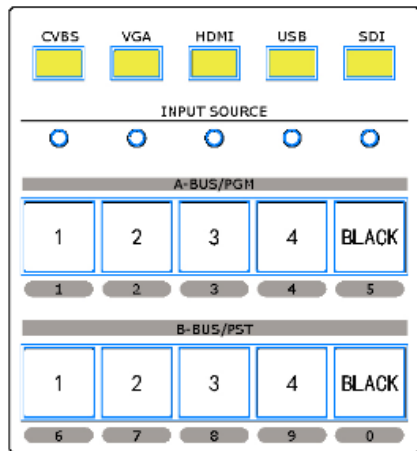

CVBS signal source button, push the button, the signal will be edited to preview channel.



VGA signal source button, push the button, the signal will be edited to preview channel.



HDMI signal source button, push the button, the signal will be edited to preview channel. For CP 3072S, the OLED screen will remind: CP 3072S!
There is no HDMI input module, Any question, please contact: 4008-592-114

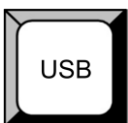

USB signal source button, push the button, the signal will be edited to preview channel.



SDI signal source button, push the button, the signal will be edited to preview channel. For CP 3072, the OLED screen will remind: CP 3072 standard version! There is no SDI input module, Any question, please contact: 4008-592-114

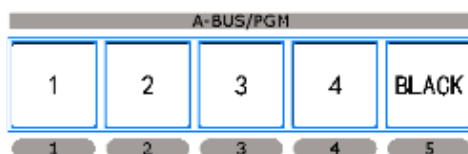

2. Hardware Orientation

CP 3072 Front Panel

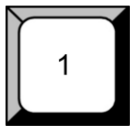

Reuse button 1: In one window mode, it is the output indicator button. In PIP mode, push the button, the preview sub-image signal will be switched to this channel. In adjustment mode, it is the number reuse button.

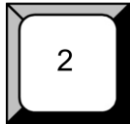

Reuse button 2: In one window mode, it is the output indicator button. In PIP mode, push the button, the preview sub-image signal will be switched to this channel. In adjustment mode, it is the number reuse button.

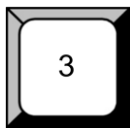

Reuse button 3: In one window mode, it is the output indicator button. In PIP mode, push the button, the preview sub-image signal will be switched to this channel. In adjustment mode, it is the number reuse button.

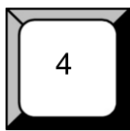

Reuse button 4: In one window mode, it is the output indicator button. In PIP mode, push the button, the preview sub-image signal will be switched to this channel. In adjustment mode, it is the number reuse button.

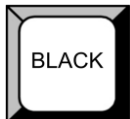

Black button, in PIP/DSK mode, push the button, program will be switched to back signal.

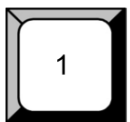
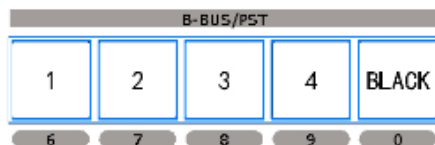

Reuse button 1: In one window mode, it is the preview edit channel indicator button. In PIP mode, push the button, the preview will be switched to this channel. In adjustment mode, it is the number reuse button.

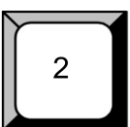

Reuse button 2: In one window mode, it is the preview edit channel indicator button. In PIP mode, push the button, the preview will be switched to this channel. In adjustment mode, it is the number reuse button.

2. Hardware Orientation

CP 3072 Front Panel

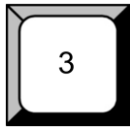

Reuse button 3: In one window mode, it is the preview edit channel indicator button. In PIP mode, push the button, the preview will be switched to this channel. In adjustment mode, it is the number reuse button.



Reuse button 4: In one window mode, it is the preview edit channel indicator button. In PIP mode, push the button, the preview will be switched to this channel. In adjustment mode, it is the number reuse button.

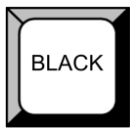

Black button, push the button, preview will be switched to this channel.

DSK, BLEND and PIP Area

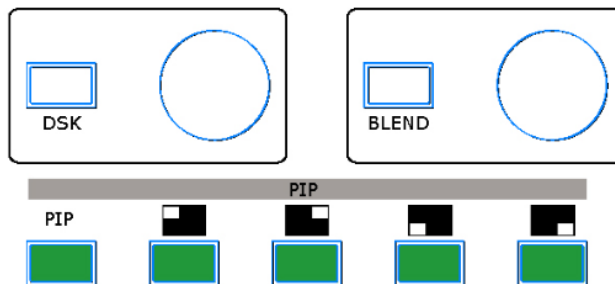

DSK effect button. In PIP mode, push the button to set the DSK effect. Details please refer to the instructions: [How to Realize the DSK Setting](#).

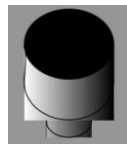

KEY LEVEL knob, in DSK mode, turn the knob to adjust the ALPHA value.



Blend effect button, in PIP mode, push the button, and enter to the BLEND effect mode. Turn the knob to set the blend width.

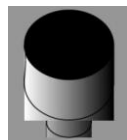

BLEND WIDTH knob, in BLEND mode, turn the knob to adjust the blend width. The adjustment range is according to the size of the image.

2. Hardware Orientation

CP 3072 Front Panel

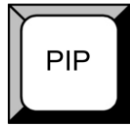

PIP function button: Single or dual image selection button, push the button, its LED light turns on, PIP function is open. Push the button again, its LED light turns off, PIP function is close, and return to single image.



PIP layout shortcut button: PIP L+T.



PIP layout shortcut button: PIP R+T.



PIP layout shortcut button: PIP L+B.



PIP layout shortcut button: PIP R+B.

Effects Operation Area



Wipe pattern shortcut button, there are 5 kinds of mode: $\leftarrow \square \rightarrow$, $\rightarrow \square \leftarrow$, $\leftarrow + \rightarrow$, $\rightarrow + \leftarrow$, $\leftarrow 0 \rightarrow$.



Wipe pattern shortcut button, there are 5 kinds of mode: L \rightarrow R, L \leftarrow R, T \rightarrow B, B \rightarrow T, I \rightarrow .



Wipe pattern shortcut button, there are 3 kinds of mode: LT \rightarrow RB, L \leftarrow M \rightarrow R, T \leftarrow M \rightarrow B.

2. Hardware Orientation

CP 3072 Front Panel

CUT Wipe pattern shortcut button: CUT.



MIX Wipe pattern shortcut button: FADE.



Output Format Setting Area

OUTPUT FORMAT

FORMAT



 SD

 HD

 RGB



Output format button. Push the button to enter to the output format, and turn the knob to choose the different output formats. CP 3072 supports 5 kinds of output formats, including: 1024x768@60, 1280x768@60, 1280x1024@60, 1440x900@60, 1920x1080@60.

 **SD** The indicator is on when the output format is SD.

 **HD** The indicator is on when the output format is HD.

 **RGB** The indicator is on when the output format is RGB.

Lock Top Panel Area



Lock button, push the button, its LED light turns on, and the buttons in the top panel are locked, push the button again, its LED light turns off, and unlock the top panel.

2. Hardware Orientation

CP 3072 Front Panel

Transition Time Control Area

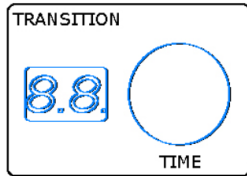

OLED panel: Show the transition switch time.

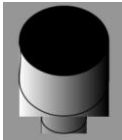

TIME knob, turn the knob to adjust the transition time.

T-bar Control Area

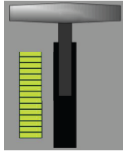
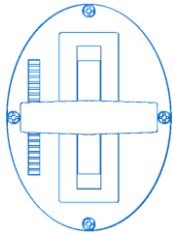

T-bar switcher, choose the effect modes, and then push the T-bar switcher up or down to switch the effects to output.

Auto Switch Button



Preview seamless effect switch button, choose the preview effect mode, and then push the button to switch the effects to output.

3. Hardware Installation



In This Chapter

This chapter provides comprehensive installation instruction for CP 3072 hardware:

CP 3072 is specified flight case packing, and following are the size of CP 3072 (Figure 1) and flight case (Figure 2) for your reference.

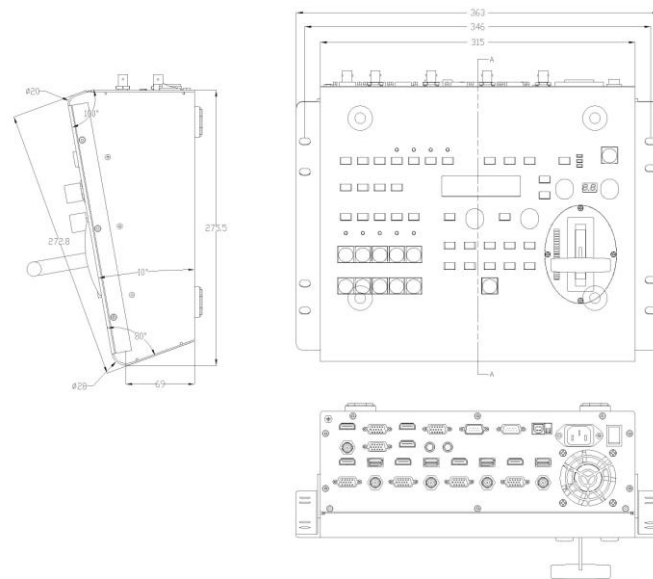

(Figure 1)

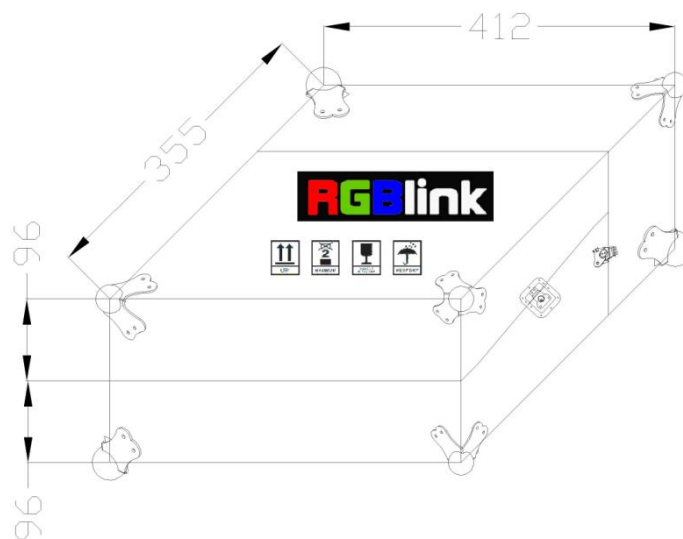

(Figure 2)

Safety Precautions

For all CP 3072 processor installation procedures, please observe the following important safety and handling rules to avoid damage to yourself and the equipment.

- To protect users from electric shock, ensure that the chassis connects to earth via the ground wire provided in the AC power Cord.
- The AC Socket-outlet should be installed near the equipment and be easily accessible.

Unpacking and Inspection

Before opening CP 3072 process shipping box, inspect it for damage. If you find any damage, notify the shipping carrier immediately for all claims adjustments. As you open the box, compare its contents against the packing slip. The packing slip includes 1 power cord, 1 USB cable, 1 9-pin serial cable, 2 HDMI to DVI cables, 1 U disk and 1 parts bag, which include 1 PVC bag, 1 CP 3072 silkscreen, 1 standard screwdriver, 2 blank key caps and 2 T-bar gasket. If you find any shortages, contact your sales representative.

Once you have removed all the components from their packaging and checked that all the listed components are present, visually inspect the system to ensure there was no damage during shipping. If there is damage, notify the shipping carrier immediately for all claims adjustments.

To prevent the damage, we pack the flight case in an additional carton. Carton damage is not within the scope of warranty.

Site Preparation

The environment in which you install your CP 3072 should be clean, properly lit, free from static, and have adequate power, ventilation, and space for all components.

4. Menu Orientation

In This Chapter

This chapter describes all CP 3072 processor menus, including how they are accessed, the functions that are available, and descriptions of each menu tree (in block diagram format).

The following topics are discussed:

- **MENU**
 - INPUT
 - OUTPUT
 - SYSTEM
 - LANGUAGE
 - FACTORY RESET

4. MENU Orientation

MENU

MENU

Push **MENU** button to enter to menu item, menu shown as follows. Turn the knob to select menu item. After the menu means it's in selected state.

Turn the knob to enter corresponding for setting or view the menu.

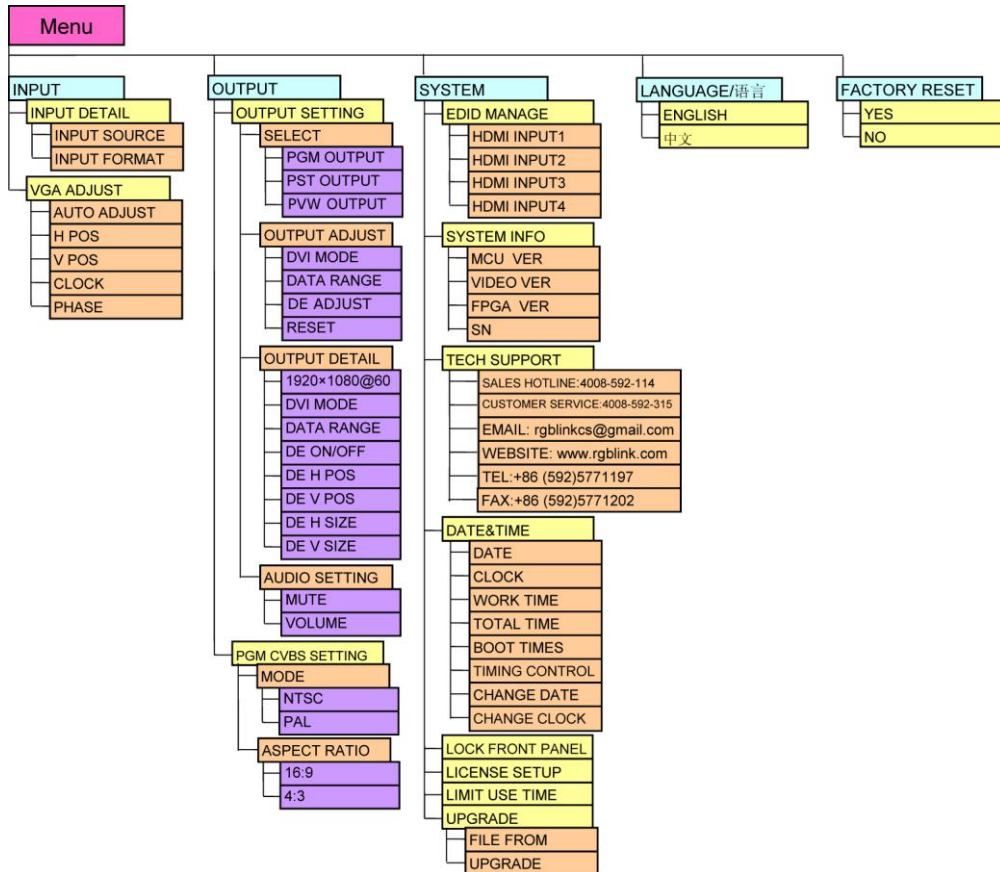

INPUT

Select <INPUT>, push the knob to confirm, show level 2 menus as follows:

INPUT DETAIL: Display input source and input format.

VGA ADJUST: Adjust VGA input signal, sub menu as follows:

AUTO ADJUST: Auto adjust VGA input signal H POS, V POS, CLOCK,

PHASE, auto adjust to display in full screen image.

Note

Comments customers to use this operation in adjusting the VGA input shiftment.

H POS: Image horizontal position.

V POS: Image vertical position.

4. MENU Orientation

MENU

CLOCK: Input signal clock.

PHASE: Input image phase.

Note

Only comments to professional operator.

OUTPUT

Select <OUTPUT>, push the knob to confirm, show level 2 menus as follows:

OUTPUT SETTING: Output setting menu, including sub-menu as follows:

1. SELECT: User can choose PGM output, PST output and PVW output.

2. OUTPUT ADJUST: Output adjust menu, including sub-menu as follows:

DVI MODE: Can set the protocol as HDMI or DVI, default is DVI output, HDMI signal output will enable when HDMI option checked.

DATA RANGE: DVI1 output range, can set as RGB (graphic mode or YCbCr (video mode), RGB output scale adjustment range is 0~255, YCbCr adjustment range is 16 to 235.

DE ADJUST: DE adjust, the sub-menu as following:

DE ON/OFF: Can choose to open or closed when choose "ON", user can set H SIZE, V SIZE, H POS, V POS, V SIZE, H POLARITY and V POLARITY.

When the signal source of the screen appear black side, user can adjust by this function to achieve the image full size display.

RESET: If image quality distorts by improper operation, it can be recover by reset.

3. OUTPUT DETAIL: Output detail menu, the sub-menu as following:

FORMAT: Show the current output format.

DVI MODE: Show the DVI mode.

DATE RANGE: Show the date range as VIDEO or IMAGE.

4. MENU Orientation

MENU

DE: Show the DE state.

DE H POS: Show the horizontal phase.

DE V POS: Show the vertical phase.

DE H SIZE: Show the horizontal size.

DE V SIZE: Show the vertical size.

4. AUDIO SETTING: User can choose open or close the audio function and set the volume, the volume adjustment range is 0~100.

PGM CVBS SETTING: User can choose the mode and aspect ratio.

MODE: Including NTSC or PAL.

ASPECT RATIO: Including 16:9 and 4:3.

SYSTEM

Select <SYSTEM>, push the knob to confirm, show level 2 menus as follows:

EDID MANAGE: User can choose HDMI INPUT1, 2, 3, or 4, and set the input source as DVI or HDMI.

SYSTEM INFO: System information.

MCU VER: Information of MCU version.

VIDEO VER: Information of VIDEO version.

FPGA VER: Information of FPGA version.

SN: Factory serial number of CP 3072.

TECH SUPPORT: Including sales hotline, custom service, web site, email and telephone.

DATE&TIME: Display date or time, including the following items:

DATE: Display date.

CLOCK: Display clock.

WORK TIME: Display the working time from boot to present.

TOTAL TIME: Total working time.

BOOT TIMES: Boot times.

4. MENU Orientation

MENU

TIMING CONTROL: Timing control switch.

CHANGE DATE.

CHANGE CLOCK.

LOCK FRONT PANEL: Through this setting can choose whether to lock the keys, if the key is locked, the device will remind: "LOCK PANEL, PRESS LOCK KEY TO RELEASE!" User can push the [LOCK] key to release device.

LICENSE SETUP: The device will not work if excess the prescribed time, there are no signal output, it needs to input password and modify the using time to continue to work.

LIMIT USE TIME: Display the rest of the working time.

UPGRADE: Choose the file and update the device.

LANGUAGE

Through this option, user can choose Chinese or English according to their needs to operate the interface more quickly.

FACTORY RESET

Enter FACTORY RESET to reset the device, choose YES and push the knob to confirm, then CP 3072 is reset to its factory settings. It is ready for more operations after completing factory setting.

5. System Setup and Operations

In This Chapter

This chapter provides comprehensive instructions for system setup and operations. The following topics are discussed:

- [Interface and Input Signal Option](#)
- [How to Change the Transition Effects](#)
- [How to Choose the Output Format](#)
- [How to Edit the Channel Signal](#)
- [How to Realize Single Image Switching](#)
- [How to Scale the Image](#)
- [How to Crop the Image](#)
- [How to Set the Position of the Image](#)
- [How to Set up the PIP](#)
- [How to Use Black Out](#)
- [How to Realize the BLEND Setting](#)
- [How to Realize the DSK Setting](#)
- [How to Save the Parameter](#)
- [How to Load the Saved Parameter](#)

5. System Setup and Operations

Interface and Input Signal Option

Interface and Input Signal Option

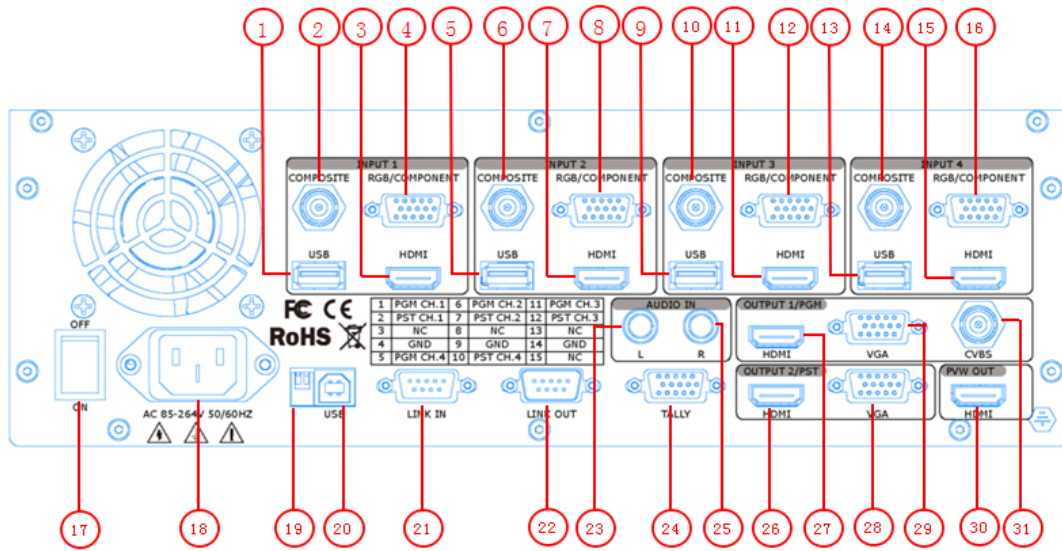

NO	INTERFACE	NO	INTERFACE
1. 5. 9. 13	USB input USB-B port	23. 25	Audio input port
2. 6. 10. 14	CVBS input BNC port	24	TALLY light
3. 7. 11. 15	HDMI/3G-SDI input	27	HDMI program output HDMI-A port
4. 8. 12. 16	VGA input DB15 port	29	VGA program output DB15 port
17	Switch	31	CVBS program output BNC port
18	Power IEC-3	26	HDMI preview output HDMI-A port
19	Dial Switch	28	VGA preview output DB15 port
20	USB Interface	30	HDMI PVW output HDMI-A port
21. 22	RS-232 Interface		

27. HDMI program output, used to connect to the display device, video processor or matrix.

29. VGA program output, connect to monitor or projector which with VGA interface. Support the following output resolutions:

1024×768@60, 1280×768@60, 1280×1024@60, 1440×900@60,

1920×1080@60.

31. CVBS Program output, connect to TV, and the device with CVBS input.

5. System Setup and Operations

Interface and Input Signal Option

26. HDMI preview output, used to connect to the display device, video processor or matrix.

28. VGA preview output, connect to monitor or projector which with VGA interface.

30. HDMI PVW output, used to connect to the display device, video processor or matrix.

1. 5. 9. 13. USB input, can access the USB device or mobile hard disk with USB storage function. Support general image and video formats. (CP 3072 V1.1 can only support video formats)

2. 6. 10. 14. CVBS output, receive standard video signal from players, cameras etc. Input supported resolution 480i and 576i via BNC. Supported standards include: PAL and NTSC.

3. 7. 11. 15. HDMI Input, input the video signal from HD player, DVD, computer, set top box and hard disk, etc. (Only for CP 3072)

3. 7. 11. 15. 3G-SDI Input, input video signal from HD camera and radio processing equipment, connect SDI interface via 75 ohms impedance BNC port. (Only for CP 3072S)

4. 8. 12. 16. VGA (DB15 Port), can support HD player, computer, video signal. Through the DB15 interface input signal.

18. Power: AC 85-264V, 50/60Hz, IEC-3 power interface.

5. System Setup and Operations

How to Change the Transition Effects

How to Change the Transition Effects

1. Push the Effect Modes button in Effects Operation Area, there are 15 kinds of effect modes:

Push the wipe pattern shortcut button  , there are 5 kinds of mode: $\leftarrow \square \rightarrow$, $\rightarrow \square \leftarrow$, $\leftarrow + \rightarrow$, $\rightarrow + \leftarrow$ and $\leftarrow 0 \rightarrow$.

Push the wipe pattern shortcut button  , there are 5 kinds of mode: L→R, L←R, T→B, B→T and III→.

Push the wipe pattern shortcut button  , there are 3 kinds of mode: LT→RB, L←M→R and T←M→B.

Push the wipe pattern shortcut button  , user can choose cut mode.

Push the wipe pattern shortcut button  , user can choose fade in fade out mode.

2. Push the [TAKE] button, or use T-bar switcher to switch between the image with effects.

Note: T-bar is only available for fade.

5. System Setup and Operation

How to Choose the Output Format

How to Choose the Output Format

1. Push the [FORMAT] button in Output Format Setting Area, the button light is on, and enter to the output formats menu items.



OUTPUT FORMAT
>1920x1080@60

2. Turn the knob and choose the output format according to actual need, for example, choose 1024x768@60:



OUTPUT FORMAT
*1024x768@60

3. Push the knob to confirm.

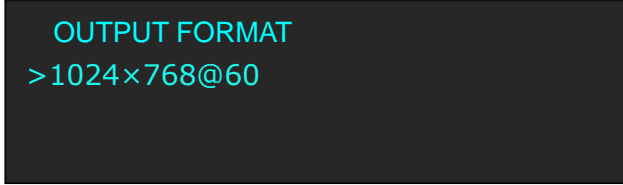

OUTPUT FORMAT
>1024x768@60

5. System Setup and Operation

How to Edit the Channel Signal

How to Edit the Channel Signal

1. Push any button of 1~4 in B-BUS/PST bar in Input Sources Edit Area, the button light flashes, which means the button can be edited. For example, push button 2:

```
B-BUS INPUT   : INPUT 2  
INPUT SOURCE: HDMI  
RESOLUTION   : NO INPUT
```

2. Push any signal button in Input Sources Edit Area, For example, push [VGA] button, then the signal of channel 2 will be switched to VGA.

```
B-BUS INPUT   : INPUT 2  
INPUT SOURCE: VGA  
RESOLUTION   : NO INPUT
```

5. System Setup and Operation

How to Realize Single Image Switching

How to Realize Single Image Switching

CP 3072 can realize seamless effects switch between two channels, choose the channel in B-BUS/PST area, then push the [TAKE] button, the signal will be switched to LED display.

For example, switch channel 2 to LED display, first push the [2] button in B-BUS/PST area, then push the [TAKE] button or T-bar in T-bar control area, and the LED display will show the signal of channel 2.

System default the switch time is 1 second for [TAKE] button, if need to adjust the fade time, turn the knob in transition time control area, and set according to actual need, push the [TAKE] button again, the signal will be switched to the LED display with the adjusted time.

5. System Setup and Operation

How to Scale the Image.

How to Scale the Image

1. Push the [SCALE] button in Function Edit Area and enter to the scale function menus.
2. Turn the knob, choose H SIZE or V SIZE and set according to actual need, user can adjust the items by the knob or number buttons, after setting, push the knob to confirm.
3. If image quality distorts by improper operation, it can be recover by reset.



>H SIZE	1920
V SIZE	1080
RESET	

5. System Setup and Operation

How to Crop the Image

How to Crop the Image

1. Push the [CROP] button in Function Edit Area and enter to the crop function menus.
2. Turn the knob, choose H SIZE, V SIZE, H POS or V POS, and set according to actual need, user can adjust the items by the knob or number buttons, after setting, push the knob to confirm.
3. If image quality distorts by improper operation, it can be recover by reset.

```
>H SIZE      1024
V SIZE       768
H POS        0
V POS        0
```

```
>RESET
```

5. System Setup and Operation

How to Set the Position of the Image

How to Set the Position of the Image

1. Push the [POS] button in Function Edit Area and enter to the position adjustment function menus.
2. Turn the knob, choose H POS or V POS, and set according to actual need.
User can adjust the items by the knob or number buttons, after setting, push the knob to confirm.
3. If image quality distorts by improper operation, it can be recover by reset.

```
>H POS      0
V POS      0
RESET
```

5. System Setup and Operation

How to Set up the PIP

How to Set up the PIP

Push the [PIP] button in PIP Operation Area, and enter to the PIP function menus. Turn the knob and choose <PIP> option, push the knob to confirm. Turn the knob, choose ON to enable the PIP function.



LAYOUT: There are 7 kinds of PIP layouts, PIP L+T, PIP R+T, PIP L+B, PIP R+B, PIP CENT, PBP L+R and PBP T+B. Take 3 results for example, shown as follows:

PIP L+T



PBP L+R



PBP T+B



SELECT: Choose the channel for operation, user can choose the channel of A BUS or B BUS.

5. System Setup and Operation

How to Use Black Out

How to Use Black Out

Black out descriptions:

Black signal realizes one-key-touch to a black screen.

CP 3072 provides black effect processing for program output and preview output, with cut black effect. Operation is as below:

Push the [BLACK] button in A-BUS/PGM bar, the button light is on, then the program output is cut to black.

Push the [BLACK] button in B-BUS/PST bar, the button light is on, then the preview output is cut to black.

The effect is shown as below:

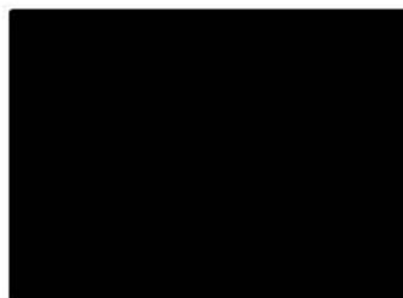

5. System Setup and Operation

How to Realize the BLEND Setting

How to Realize the BLEND Setting

1. First, set PIP mode, or user can not set blend.
2. Push the [BLEND] button in BLEND Operation Area, the OLED panel shows as follows:

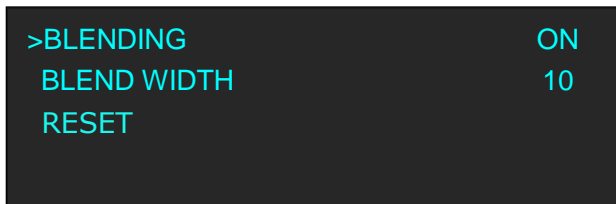

The screenshot shows the OLED panel with the following text displayed in cyan on a black background:

>BLENDING	ON
BLEND WIDTH	10
RESET	

3. Turn the knob, and choose <BLENDING>, push the knob to confirm.
Turn the knob, choose “ON”, push the knob to confirm.
4. Turn the knob, and choose <BLEND WIDTH>, push the knob to confirm. Turn the knob to set the blend width.
5. If image quality distorts by improper operation, it can be recover by reset.

5. System Setup and Operation

How to Realize the DSK Setting

How to Realize the DSK Setting

1. First, set PIP mode, or user can not set DSK.
2. Push the [DSK] button in DSK Operation Area, the OLED panel show as follows:

SELECT	A BUS
>MODE	DSK
COLOR	WHITE
BACKDROUND:	BLACK/BLUE

>Y OFFSET	0
Cb OFFSET	0
Cr OFFSET	0
RESET	

SELECT: User can choose the signal of A BUS channel or B BUS channel.

MODE: There are 2 kinds of preset modes, DSK and KEY.

COLOR: The colors include white, yellow, cyan, green, red, blue and black.

BACKGROUND: User can choose black or blue.

Y, Cb, Cr OFFSET. User can optimize the effect if DSK or KEY is poor by color offset setting. Suggest priority setting of Y offset. If image quality distorts by improper operation, it can be recover by reset

3. Turn the KEY LEVEL knob to set the Alpha, the adjustment range is 0 to 100.

5. System Setup and Operation

How to Save the Parameter

How to Save the Parameter

There are 4 pages and each page has 4 save modes, CP 3072 provides 16 save modes.

1. Push the [SAVE] button, the button light turns on, and PAGE, 1, 2, 3 and 4 button lights flash.

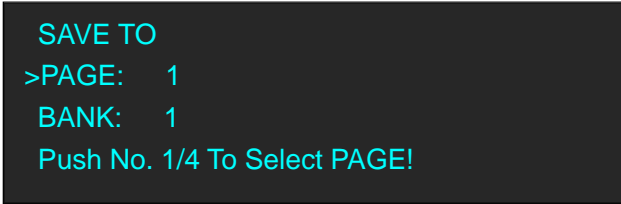

```
SAVE TO
>PAGE:  1
BANK:   1
Push No. 1/4 To Select PAGE!
```

2. First set PAGE, for example, choose 1:

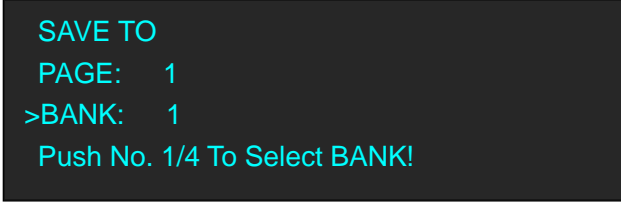

```
SAVE TO
PAGE:   1
>BANK:  1
Push No. 1/4 To Select BANK!
```

3. Then set BANK, buttons 1 to 4 are on or flash, the button on can be saved and flash will be overwrite, push the button on to save. For example, choose 1:

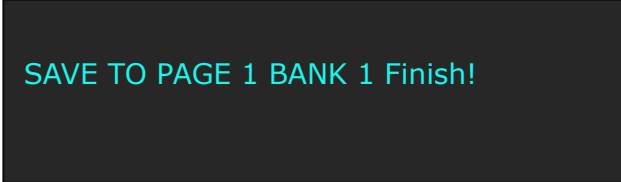

```
SAVE TO PAGE 1 BANK 1 Finish!
```

4. Push the [SAVE] button again, the button light turns off, and close the SAVE function.

5. System Setup and Operation

How to Load the Saved Parameter

How to Load the Saved Parameter

There are 4 pages and each page has 4 save modes, CP 3072 provides 16 save modes for load.

1. Push the [LOAD] button, the button light turns on, and PAGE, 1, 2, 3 and 4 button light flash.

```
LOAD FROM
>PAGE:  1
BANK:   1
Push No. 1/4 To Select PAGE!
```

2. First set PAGE, for example, choose 1:

```
LOAD FROM
PAGE:   1
>BANK:  1
Push No. 1/4 To Select BANK!
```

3. Then set BANK, buttons 1 to 4 are on or flash, the button on is ready for recall and flash means just recall, push the button on to recall. For example, choose 1:

```
LOAD FROM PAGE 1 BANK 1 Finish!
```

6. Common Questions and Solutions

In This Chapter

This chapter provides the common questions and solution for the video processor. The following topics are provided:

- [The USB doesn't Play Video Well](#)
- [Flash Point in LED Display Output](#)
- [The HDMI Input Signal of Blu-ray DVD cannot be Shown](#)
- [No Sound Output from Output Port](#)
- [VGA Input Offset or cannot be Full Size Shown](#)

The USB doesn't Play Video Well

Confirm if There are Multiple Videos in USB Root Directory

Pull out the USB from CP 3072 and plug in to the computer, check if there is video in USB root directory, do not save other non-video files at the same time. User can also copy some video files to the USB after formatting it.

Confirm If There is Signal Output

If CP 3072 works well before, but the USB can't play after restart, user can pull and plug the USB for test under normal operation and UPS.

Flash Point in LED Display Output

Confirm If Monitor Output is Normal

Find a belt VGA input (best for DVI) display, connect to the corresponding output port of processor, and check whether the signal is correct on the monitor. If display normally shows and no flash point, please check whether DVI outlets put tight. If display flashes point, please judge if input signal, wire, and interface are normal.

The HDMI Input Signal of Blu-ray DVD cannot be Shown

Choose HDMI Signal as HDMI Input

Choose HDMI signal as HDMI input. Push the [MENU] button, then choose <SYSTEM>, turn the knob and choose <EDID MANAGE>, choose the HDMI input and set the input source as HDMI. User need to restart the blu-ray DVD.

No Sound Output from Output Port

Confirm if the DVI Mode of PGM Output is HDMI

System default the DVI mode of PGM output is DVI, this format cannot support the digital audio signal, user should set the format as HDMI, specific operations as follows: Push the [MENU] button, then choose <OUTPUT>, turn the knob and choose <OUTPUT SETTING>, push the knob to confirm. Turn the knob to choose PGM OUTPUT in <SELECT> option, then set the DVI mode as HDMI in <OUTPUT ADJUST>.

VGA Input Offset or cannot be Full Size Shown

Set Auto Adjust for VGA Input

Push the [MENU] button, then choose <INPUT>, turn the knob and choose <VGA ADJUST>, push the knob to confirm. Turn the knob and choose <AUTO ADJUST>, the auto adjust time is about 10 seconds. If auto adjust cannot solve the problem, please manually adjust in <VGA ADJUST>.

A. Specification



CVBS BNC Input	
Number of Inputs	4
Supported Standards	PAL/NTSC/SECAM
Signal Level	1Vpp±3db (0.7V Video+0.3v Sync) 75 ohm
Multiplex	480i,576i
VGA DB15 Input	
Number of Inputs	4
Connector	Standard DB15 Socket
Supported Standard	VGA-UXGA
Signal Level	R、G、B、Hsync、Vsync:0 to1Vpp±3dB (0.7V Video+0.3v Sync) 75 ohm black level: 300mV Sync-tip: 0V
Supported Resolution	VGA-UXGA
USB Input	
Number of Inputs	4
Connector	Standard USB port
Supported Standard	Support general Image and video formats (CP 3072 V1.1 can only support video formats)
HDMI Input (Only for CP 3072)	
Number of Inputs	4
Connector	HDMI standard type A interface
Supported Resolution	SMPTE: 625/25 PAL, 525/29.97 NTSC, 625/50p PAL, 525/59.94p NTSC 720p50,720p59.94/60, 1080i50, 1080i59.94/60 VESA: 1024×768@60Hz, 1280×768@60Hz, 1280×1024@60Hz, 1920×1080@60Hz, 1920×1080@50Hz
Embedded Audio Channels	Choose 1 in 2
Format Standard	HDMI 1.3
3G-SDI Input (Only for CP 3072S)	
Number of Inputs	4
Connector	BNC
Data Rate	2.97Gb/s, 2.97/1.001Gb/s, 1.485Gb/s, 1.485/1.001Gb/s and 270Mb/s
Supported Standard	SMPTE 425M (Level A and Level B), SMPTE424M, SMPTE 292M, SMPTE 259M-C and DVB-ASI
Balance	Belden 1694A cable: 150m at 2.97Gb/s

	250m at 1.485Gb/s 480m at 270Mb/s
CVBS Program Output	
Number of Outputs	1
Supported Standards	PAL/NTSC/SECAM
Signal Level	1Vpp±3db (0.7V Video+0.3v Sync) 75 ohm
HDMI Program Output	
Number of Outputs	1
Connector	HDMI standard type A interface
Supported Resolution	VESA: 1024×768@60Hz, 1280×768@60Hz, 1280×1024@60Hz, 1920×1080@60Hz, 1920×1080@50Hz
Format Standard	HDMI 1.3, DVI 1.0
VGA Program Output	
Number of Outputs	1
Connector	Standard DB15 Socket
Supported Resolution	VESA: 1024×768@60Hz, 1280×768@60Hz, 1280×1024@60Hz, 1920×1080@60Hz, 1920×1080@50Hz
Signal Level	R、G、B、Hsync、Vsync:0 to1Vpp±3dB (0.7V Video+0.3v Sync) 75 ohm black level: 300mV Sync-tip: 0V
HDMI Preview Output	
Number of Outputs	1
Connector	HDMI standard type A interface
Supported Resolution	VESA: 1024×768@60Hz, 1280×768@60Hz, 1280×1024@60Hz, 1920×1080@60Hz, 1920×1080@50Hz
Format Standard	HDMI 1.3, DVI 1.0
VGA Preview Output	
Number of Outputs	1
Connector	Standard DB15 Socket
Supported Resolution	VESA: 1024×768@60Hz, 1280×768@60Hz, 1280×1024@60Hz, 1920×1080@60Hz, 1920×1080@50Hz
Signal Level	R、G、B、Hsync、Vsync:0 to1Vpp±3dB (0.7V Video+0.3v Sync) 75 ohm black level: 300mV Sync-tip: 0V
HDMI PVW Output	
Number of Outputs	1
Connector	HDMI standard type A interface
Supported Resolution	1024×768@60Hz

Format Standard	HDMI 1.3
Function	
Input channel configuration	Support each input channel signal programming configuration
PIP	Support PIP, PBP for any two inputs
Audio sync switch	support
Extras	
Communication	Top panel operation
Power Supply	85-264V, IEC-3
Working Environment	0°C~45°C
Stored Environment	10% to 90%
Product Warranty	3-year parts and labor warranty

B. Contact Information



Warranty:

All video products are designed and tested to the highest quality standard and backed by a full 3-year parts and labor warranty. Warranties are effective upon delivery date to customer and are non-transferable. RGBlink warranties are only valid to the original purchase/owner. Warranty related repairs include parts and labor, but do not include faults resulting from user negligence, special modification, lighting strikes, abuse(drop/crush), and/or other unusual damages.

The customer shall pay shipping charges when unit is returned for repair.

Headquarter: S603~604 Weiye Building Torch Hi-Tech Industrial Development Zone Xiamen, Fujian Province, P.R.C.

- **Tel:** +86-592-5771197
- **Fax:** +86-592-5771202
- **Customer Hotline:** 4008-592-315
- **Websites:**
 - ~ <http://www.rgblink.com>
 - ~ <http://www.rgblink.cn>
- **E-mail:** support@rgblink.com

C. Software Upgrade

The CP 3072 software upgrade steps are as follows:

1. Communication Firmware Upgrade

Upgrade by “DfuSe Demonstration”, the form of the file is .dfu (as shown in Figure 1), and the upgrade steps are as follows:



Figure 1

(1) Connect the USB interface of CP 3072 to the computer with a USB cable (as shown in Figure 2).



Figure 2

(2) Dial the red dial switch behind the device upwards (as shown in Figure 3).



Figure 3

(3) Plug in the power cord, and make sure the device is in normal operation.

(4) Open the upgrade file, and enter to the “DfuSe Demonstration” interface (as shown in Figure 4). If connect to the device successfully, the area marked with red box will show connect, or it is empty.

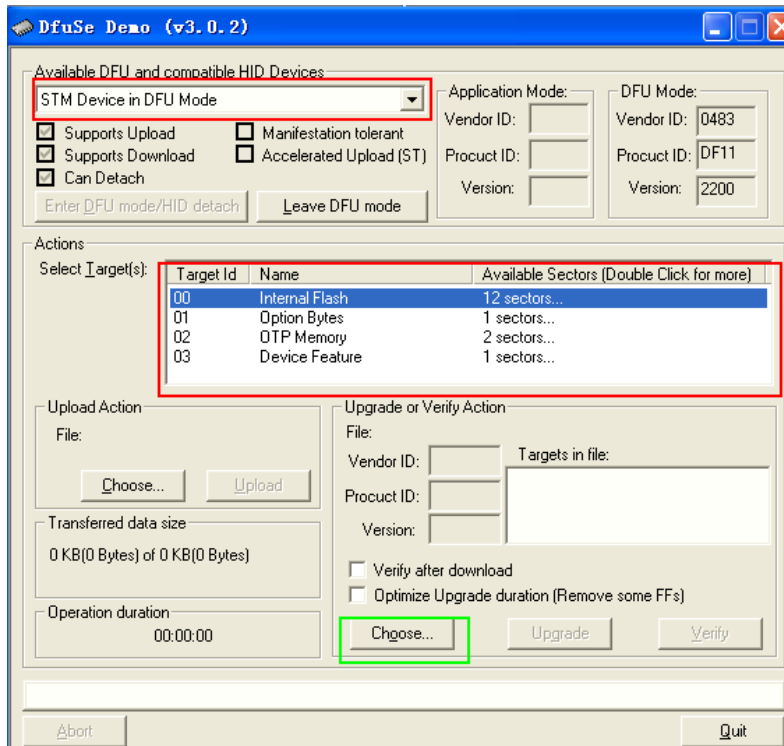

Figure 4

- (5) Click the button marked by green box after connection, choose the upgrade file, and click “Upgrade”, then pop up the confirmation window as shown in Figure 5, it will show as Figure 6 if upgrade successful.



Figure 5

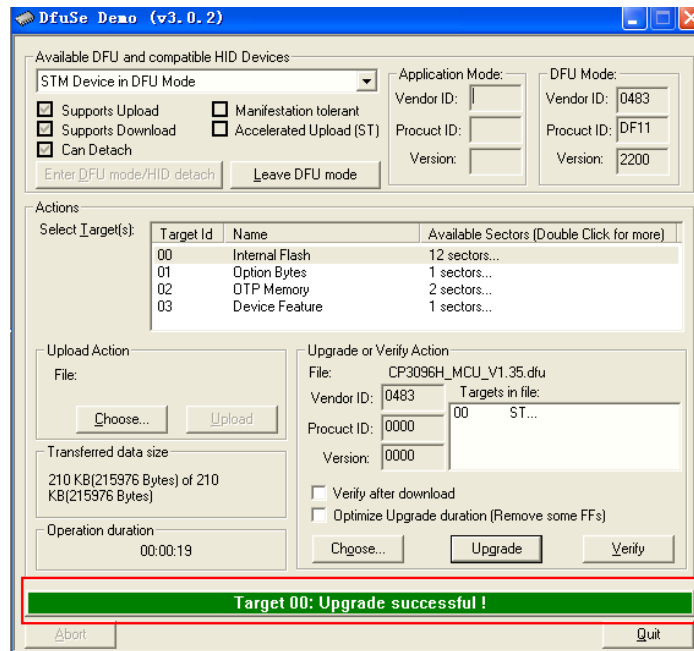

Figure 6

(6) Exit the program after upgrade, and power off, then dial the dial switch downwards.

2. Core Processing Firmware Upgrade

Upgrade by windows control program "UpdateProgram.exe", the form of the file is .bin.bin, and upgrade steps are as follows:

(1) Connect the USB interface of CP 3072 to the computer with a USB cable.





(2) Plug in the power cord, and make sure the device is in normal operation.

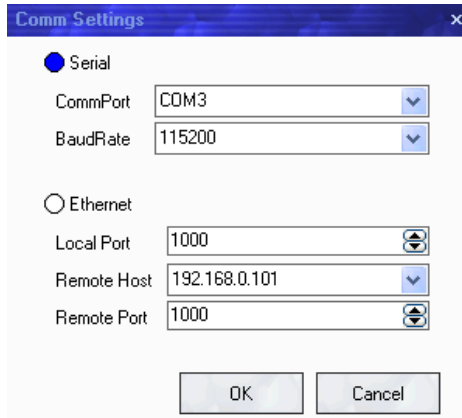

(3) Open the windows control program, click the serial icon on top left corner to set the serial, choose the serial port that connected to the computer, and set BaudRate as 115200, click "OK" after setting.

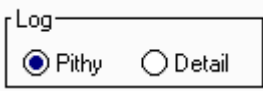
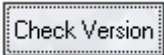

Note: If not recognize the serial port, please check if install the USB driver correctly. User can download the VCP_V1.3.1_Setup.exe file after install the USB driver. Choose the system type (32 bit or 64 bit). User can also download the driver wizard or driver home on internet to test and install the driver.

(4) After choose the serial port, show the log option as  , choose "Pithy", then click  button, when prompt  , choose the upgrade file, (the form of the file is .bin.bin), and click "Start" to upgrade core processing firmware.

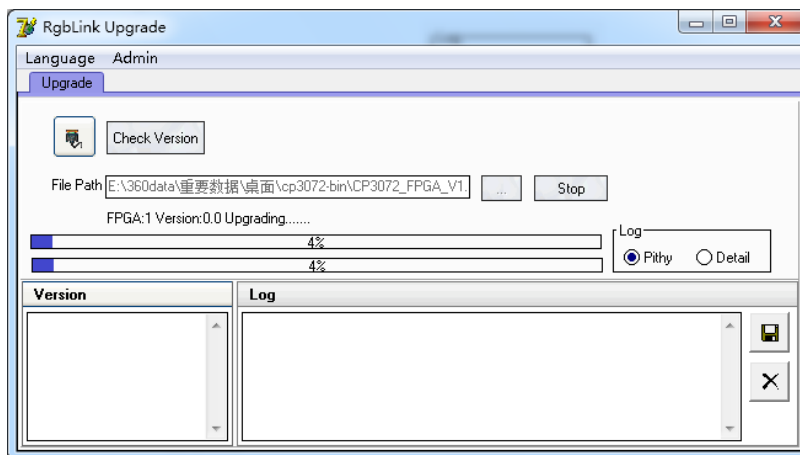

(5) When prompt "Down Load Success", it means load is successful.

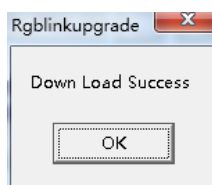

(6) Reboot the device.

3. Player Firmware Upgrade

Upgrade by USB, the upgrade steps are as follows:

- (1) Copy the program "MERGE.bin" to the USB. (Note: In order to avoid the program loading errors, empty the USB before copying the program)
- (2) Insert the USB to the USB 1 port of CP 3072.
- (3) Boot the device, push the [MENU] button, turn the knob, choose <SYSTEM>, push the knob to confirm, turn the knob again, choose <UPGRADE>, the OLED panel show as follows:

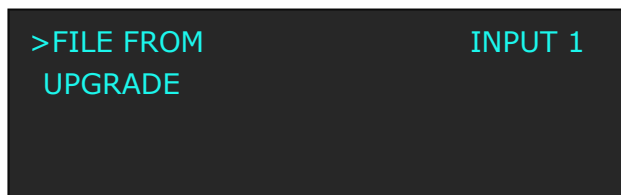

>FILE FROM INPUT 1
UPGRADE

Choose <INPUT 1> as the file, then choose <UPGRADE>, push the knob to upgrade USB 1, pull out the USB after finish, and insert the USB to the USB 2 port of CP 3072, boot the device, choose MENU-SYSTEM-UPGRADE-INPUT 2, then choose <UPGRADE> to upgrade USB 2. Same operation for USB 3 and USB 4.

- (4) After upgrade all the 4 USB ports, check the program of the device. First, switch the preview signal to channel 1, then push the [MENU] button for two times, the OLED panel will show the main menus. If the VIDEO VER is 3.6, it means USB 1 upgrade is successful.

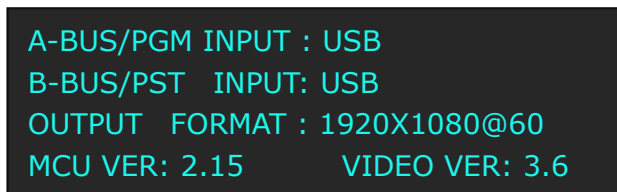

A-BUS/PGM INPUT : USB
B-BUS/PST INPUT: USB
OUTPUT FORMAT : 1920X1080@60
MCU VER: 2.15 VIDEO VER: 3.6

Same as above, switch the preview signal to channel 2, channel 3 and channel 4, USB 2, USB 3 and USB 4 are upgrade successful if VIDEO VER is 3.6.

D. Solution for Weak Damping Effects of T-bar

First, Remove the T-bar handle (unscrew loose):



Remove the screw from the opposite side, and take the square silver box down:

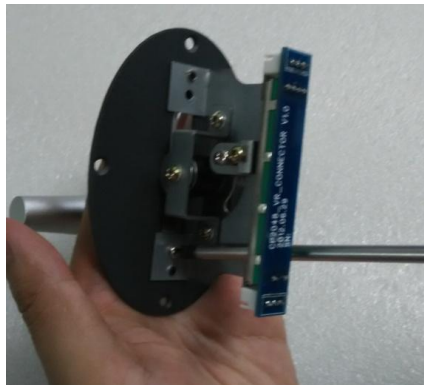

Remove the black oval plate:



Remove the four white screws, as shown below:

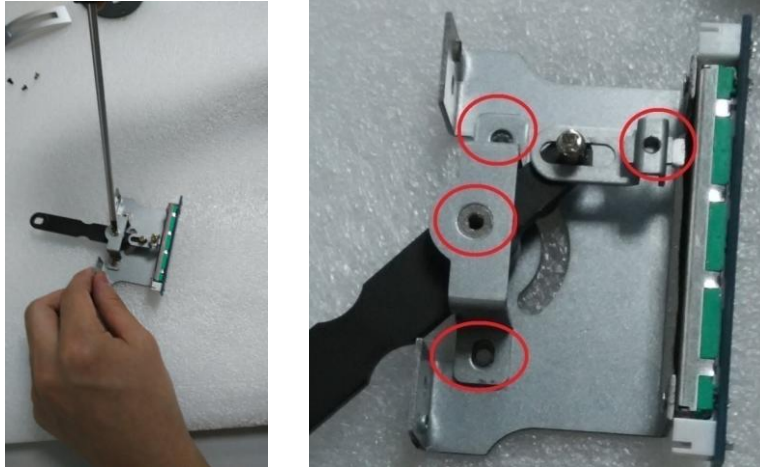

Detach the block plate, remove the gaskets, and then remove the T-bar.

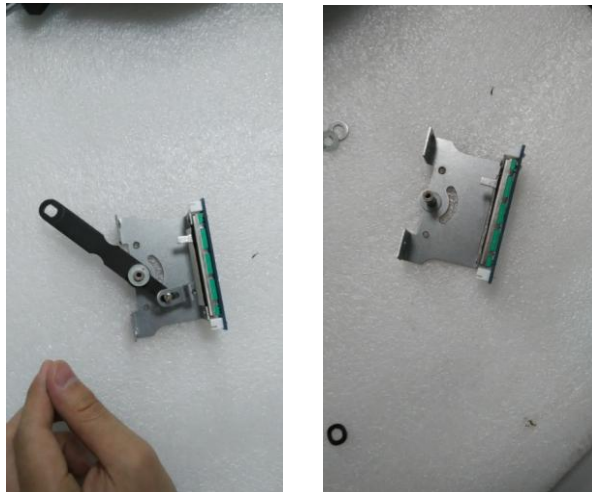

Add a black gasket, a white gasket, as shown below:



Install the T-bar, screw the two white screws first (fixed slightly):

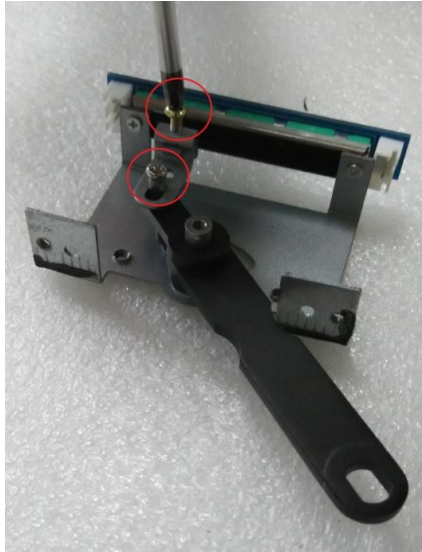
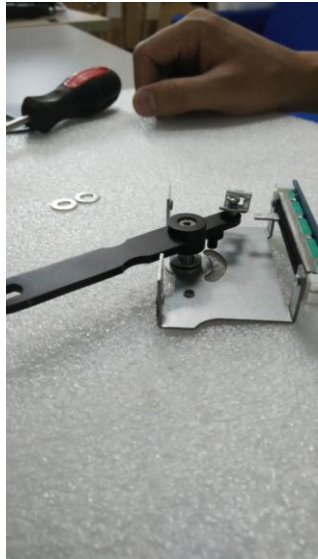

Straighten the T-bar, and add three gaskets as the following sequence: white, black, white.



Screw and fasten all the three screws.

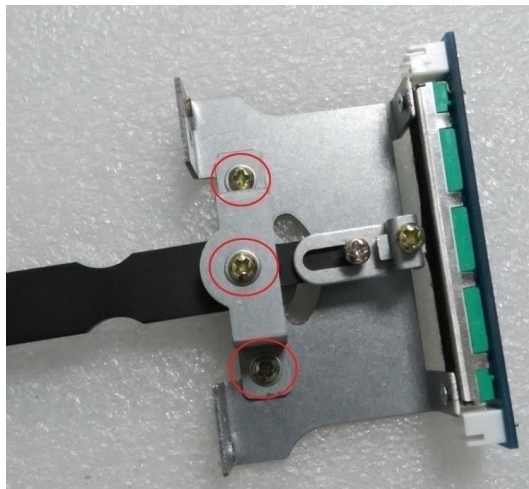

Screw the oval plate again.



Screw the square silver box from the opposite side, and then screw the handle.

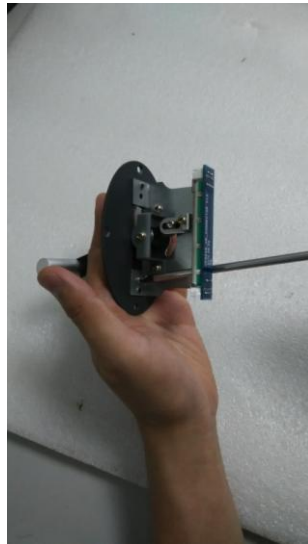

Above all steps are completed as following:

