

# RANE MP2015 MIXER MANUAL



# Important Safety Instructions



1. Read these instructions.
  2. Keep these instructions.
  3. Heed all warnings.
  4. Follow all instructions.
  5. Do not use this apparatus near water.
  6. Clean only with a dry cloth.
  7. Do not block any ventilation openings. Install in accordance with manufacturer's instructions.
  8. Do not install near any heat sources such as radiators, registers, stoves, or other apparatus (including amplifiers) that produce heat.
  9. Do not defeat the safety purpose of the polarized or grounding-type plug. A polarized plug has two blades with one wider than the other. A grounding-type plug has two blades and a third grounding prong. The wide blade or third prong is provided for your safety. If the provided plug does not fit into your outlet, consult an electrician for replacement of the obsolete outlet.
  10. Protect the power cord and plug from being walked on or pinched particularly at plugs, convenience receptacles, and the point where it exits from the apparatus.
  11. Only use attachments and accessories specified by Rane.
  12. Use only with the cart, stand, tripod, bracket, or table specified by the manufacturer, or sold with the apparatus. When a cart is used, use caution when moving the cart/apparatus combination to avoid injury from tip-over.
  13. Unplug this apparatus during lightning storms or when unused for long periods of time.
  14. Refer all servicing to qualified service personnel. Servicing is required when the apparatus has been damaged in any way, such as power supply cord or plug is damaged, liquid has been spilled or objects have fallen into the apparatus, the apparatus has been exposed to rain or moisture, does not operate normally, or has been dropped.
  15. The plug on the power cord is the AC mains disconnect device and must remain readily operable. To completely disconnect this apparatus from the AC mains, disconnect the power supply cord plug from the AC receptacle.
  16. This apparatus shall be connected to a mains socket outlet with a protective earthing connection.
  17. When permanently connected, an all-pole mains switch with a contact separation of at least 3 mm in each pole shall be incorporated in the electrical installation of the building.
  18. If rackmounting, provide adequate ventilation. Equipment may be located above or below this apparatus, but some equipment (like large power amplifiers) may cause an unacceptable amount of hum or may generate too much heat and degrade the performance of this apparatus.
  19. This apparatus may be installed in an industry standard equipment rack. Use screws through all mounting holes to provide the best support.
- WARNING:** To reduce the risk of fire or electric shock, do not expose this apparatus to rain or moisture. Apparatus shall not be exposed to dripping or splashing and no objects filled with liquids, such as vases, shall be placed on the apparatus.

## WARNING



To reduce the risk of electrical shock, do not open the unit. No user serviceable parts inside. Refer servicing to qualified service personnel.

The symbols shown below are internationally accepted symbols that warn of potential hazards with electrical products.



This symbol indicates that a dangerous voltage constituting a risk of electric shock is present within this unit.



This symbol indicates that there are important operating and maintenance instructions in the literature accompanying this unit.

**WARNING:** This product may contain chemicals known to the State of California to cause cancer, or birth defects or other reproductive harm.

**NOTE:** This equipment has been tested and found to comply with the limits for a Class B digital device, pursuant to part 15 of the FCC Rules. These limits are designed to provide reasonable protection against harmful interference in a residential installation. This equipment generates, uses and can radiate radio frequency energy and, if not installed and used in accordance with the instructions, may cause harmful interference to radio communications. However, there is no guarantee that interference will not occur in a particular installation. If this equipment does cause harmful interference to radio or television reception, which can be determined by turning the equipment off and on, the user is encouraged to try to correct the interference by one or more of the following measures:

- Reorient or relocate the receiving antenna.
- Increase the separation between the equipment and receiver.
- Connect the equipment into an outlet on a circuit different from that to which the receiver is connected.
- Consult the dealer or an experienced radio/TV technician for help.

**CAUTION:** Changes or modifications not expressly approved by Rane Corporation could void the user's authority to operate the equipment. CAN ICES-3 (B)/NMB-3(B)

# Instructions de Sécurité



1. Lisez ces instructions.
2. Gardez précieusement ces instructions.
3. Respectez les avertissements.
4. Suivez toutes les instructions.
5. Ne pas utiliser près d'une source d'eau.
6. Ne nettoyer qu'avec un chiffon doux.
7. N'obstruer aucune évacuation d'air. Effectuez l'installation en suivant les instructions du fabricant.
8. Ne pas disposer près d'une source de chaleur, c-à-d tout appareil produisant de la chaleur sans exception.
9. Ne pas modifier le cordon d'alimentation. Un cordon polarisé possède 2 lames, l'une plus large que l'autre. Un cordon avec tresse de masse possède 2 lames plus une 3<sup>e</sup> pour la terre. La lame large ou la tresse de masse assurent votre sécurité. Si le cordon fourni ne correspond pas à votre prise, contactez votre électricien.
10. Faites en sorte que le cordon ne soit pas piétiné, ni au niveau du fil, ni au niveau de ses broches, ni au niveau des connecteurs de vos appareils.
11. N'utilisez que des accessoires recommandés par Rane.
12. N'utilisez que les éléments de transport, stands, pieds ou tables spécifiés par le fabricant ou vendu avec l'appareil. Quand vous utilisez une valise de transport, prenez soin de vous déplacer avec cet équipement avec prudence afin d'éviter tout risque de blessure.
13. Débranchez cet appareil pendant un orage ou si vous ne l'utilisez pas pendant un certain temps.
14. Adressez-vous à du personnel qualifié pour tout service après vente. Celui-ci est nécessaire dans n'importe quel cas où l'appareil est abîmé : si le cordon ou les fiches sont endommagés, si du liquide a été renversé ou si des objets sont tombés sur l'appareil, si celui-ci a été exposé à la pluie ou l'humidité, s'il ne fonctionne pas correctement ou est tombé.
15. La fiche du cordon d'alimentation sert à brancher le courant alternatif AC et doit absolument rester accessible. Pour déconnecter totalement l'appareil du secteur, débranchez le câble d'alimentation de la prise secteur.
16. Cet appareil doit être branché à une prise terre avec protection.
17. Quand il est branché de manière permanente, un disjoncteur tripolaire normalisé doit être incorporé dans l'installation électrique de l'immeuble.
18. En cas de montage en rack, laissez un espace suffisant pour la ventilation. Vous pouvez disposer d'autres appareils au-dessus ou en-dessous de celui-ci, mais certains (tels que de gros amplificateurs) peuvent provoquer un buzz ou générer trop de chaleur au risque d'endommager votre appareil et dégrader ses performances.
19. Cet appareil peut-être installé dans une baie standard ou un châssis normalisé pour un montage en rack. Visser chaque trou de chaque oreille de rack pour une meilleure fixation et sécurité.

**ATTENTION:** afin d'éviter tout risque de feu ou de choc électrique, gardez cet appareil éloigné de toute source d'humidité et d'éclaboussures qu'elles soient. L'appareil doit également être éloigné de tout objet possédant du liquide (boisson en bouteilles, vases,...).

## ATTENTION



Afin d'éviter tout risque de choc électrique, ne pas ouvrir l'appareil. Aucune pièce ne peut être changée par l'utilisateur. Contactez un SAV qualifié pour toute intervention.

Les symboles ci-dessous sont reconnus internationalement comme prévenant tout risque électrique.



Ce symbole indique que cette unité utilise un voltage élevé constituant un risque de choc électrique.



Ce symbole indique la présence d'instructions d'utilisation et de maintenance importantes dans le document fourni.

REMARQUE: Cet équipement a été testé et approuvé conforme aux limites pour un appareil numérique de classe B, conformément au chapitre 15 des règles de la FCC. Ces limites sont établis pour fournir une protection raisonnable contre tout risque d'interférences et peuvent provoquer une énergie de radiofréquence s'il n'est pas installé et utilisé conformément aux instructions, peut également provoquer des interférences aux niveaux des équipements de communication. Cependant, il n'existe aucune garantie que de telles interférences ne se produiront pas dans une installation particulière. Si cet équipement provoque des interférences en réception radio ou télévision, ceci peut être détecté en mettant l'équipement sous/ hors tension, l'utilisateur est encouragé à essayer de corriger cette interférence par une ou plusieurs des mesures suivantes:

- Réorienter ou déplacer l'antenne de réception.
- Augmenter la distance entre l'équipement et le récepteur.
- Connecter l'équipement à une sortie sur un circuit différent de celui sur lequel le récepteur est branché.
- Consulter un revendeur ou un technicien radio / TV expérimenté.

**ATTENTION:** Les changements ou modifications non expressément approuvés par Rane Corporation peuvent annuler l'autorité de l'utilisateur à manipuler cet équipement et rendre ainsi nulles toutes les conditions de garantie.

CAN ICES-3 (B)/NMB-3(B)



Cartons et papier à recycler.

## Copyright Notices

©2015 Rane Corporation. All rights reserved. Windows® is a registered trademark of Microsoft Corporation in the United States and other countries. Apple, Mac, Macintosh, iTunes, Safari, QuickTime, GarageBand, and OS X are registered trademarks of Apple Inc., registered in the United States and other countries. ASIO is a trademark of Steinberg Media Technologies GMBH. Traktor, Traktor Pro and Maschine are trademarks of Native Instruments GMBH. Virtual DJ is a registered trademark of Atomix Productions Inc. Ableton is a trademark of Ableton AG.

## Check List

**These items are included in the box:**

- **MP2015 Mixer.**
- **1 USB cable.**
- **1 control panel install disc.**
- **IEC C5 line cord.**
- **This MP2015 Mixer Manual.**

## Wear Parts

The MP2015 Mixer contains no wear parts. See "Limited Warranties" on page 26.

This product is engineered, manufactured and supported by Rane Corporation in Mukilteo, WA, USA, using globally sourced materials.

## **Contents**

- 2 Important Safety Instructions**
- 4 Copyright Notices**
- 4 Check List**
- 6 MP2015 Overview**
- 8 Connections**
- 9 Deck Input Channels**
- 10 Session Input and Output**
- 10 Submix**
- 13 Headphone Cueing**
- 13 Microphone Input**
- 13 Main Mix Outputs**
- 14 USB Audio**
- 15 DJ Changeover**
- 16 Class Compliant USB Ports**
- 16 Control Panel**
- 18 MIDI Mapping**
- 20 MIDI Implementation**
- 23 Technical Specifications**
- 24 Mounting Ears Accessory**
- 25 EU Declaration of Conformity**
- 26 Limited Warranties**

# MP2015 Overview

## Highest quality user control surface

- Excellent control ergonomics with intuitive and comfortable layout.
- Potentiometers with exceptional feel and 1 million cycle life.
- Studio console grade backlit push switches.

## Digital Signal Processing

- A/D and D/A dynamic range 116 dB A-weighted, THD+N 0.0009%.
- All audio processing is 32-bit floating point with supported sample rates: 44.1 kHz, 48 kHz or 96 kHz.
- S/PDIF inputs for each Deck and Session input with
  - Dynamic range 128 dB with ultra-low jitter and 16:1 SRC conversion range.
- S/PDIF Session output to record mix or chain mixers together without analog conversion.

## 2 USB ports allow simultaneous connection of 2 computers

- Each USB port supports 10 playback and 14 record channels.
  - Simultaneously record 4 Decks, Submix, Session In and Main mix.
- USB 2.0 high-speed class compliant MIDI and Audio
  - Driver installation is not required for Mac OSX.
  - High-performance universal ASIO driver is provided for Windows.
- User control panel supports user options and status.

## Analog I/O designed with attention to detail

- Accurate, low noise RIAA stages with 3rd-order Infrasonic (rumble) and 2nd order low-pass filters.
- Transient voltage and EMI protection, turn on muting and overload protection.
- 8 Vrms balanced outputs, 4 Vrms unbalanced I/O.

## Four Deck inputs with these features:

- Select USB A, PH/CD, AUX or USB B input with Gain trim and RIAA Phono sensitivity.
  - Deck 1 USB playback channels 1-2
  - Deck 2 USB playback channels 3-4
  - Deck 3 USB playback channels 5-6
  - Deck 4 USB playback channels 7-8
- 3-band full-cut EQ with 2 selectable crossover points: Linkwitz-Riley 2nd-order
- 4th-Order Selectable Low-pass, Low/High-pass, or High-pass filter with Mode, Resonance and on/off controls.
- Main Mix Level control, Headphone Cue, Submix assign, 16-segment Q-peak meter with Peak-hold.

## Session Input with Level control

- Source may be unbalanced RCA, S/PDIF or USB AUX playback channels 9-10.
- Assigned to Main Mix or Submix, where the submix can act as a fifth input channel.

## Microphone input with 48 volt phantom power and Line-level switches

- Combo XLR and 1/4" TRS input jack.
- May be used with a condenser mic, dynamic mic or line-level (wireless) input.
- Input Level control, 1-knob Tone control, on/off switch and Duck controls.

## Unique Submix feature

- Group any number of inputs for easy and intuitive multi-source mixing.
- Channels assigned to the Submix share a common set of controls, similar to the Deck inputs.
- Assignable external Effects Loop with sensitivity, in/out and wet/dry control.

## High performance Integrated Isolator EQ

- 4th-order Linkwitz-Riley 3-band Isolator with adjustable crossover points. Exceptionally smooth.

## Main Mix with 16-segment stereo Meter

- Balanced XLR Main Output with Level control.
- Balanced 1/4" TRS Booth Output with Level control.
- Session Output with Level control.
  - S/PDIF output for digital recording or chaining mixers together.
  - Unbalanced RCA analog output.
- Effects Loop may be assigned to the Main Mix or just the Submix.

## Headphone monitor

- Level Control, Cue/Main Pan, Mono Split or Stereo Cue.
- Conveniently located 3.5 mm and 1/4" jacks on the top plate and front panel.

**USB Record outputs:**

- USB record channels 1-2: Deck 1 post-fader by default, pre-fader option in the control panel.
- USB record channels 3-4: Deck 2 post-fader by default, pre-fader option in the control panel.
- USB record channels 5-6: Deck 3 post-fader by default, pre-fader option in the control panel.
- USB record channels 7-8: Deck 4 post-fader by default, pre-fader option in the control panel.
- USB record channels 9-10: Main Mix.
- USB record channels 11-12: Submix.
- USB record channels 13-14: Session Input.

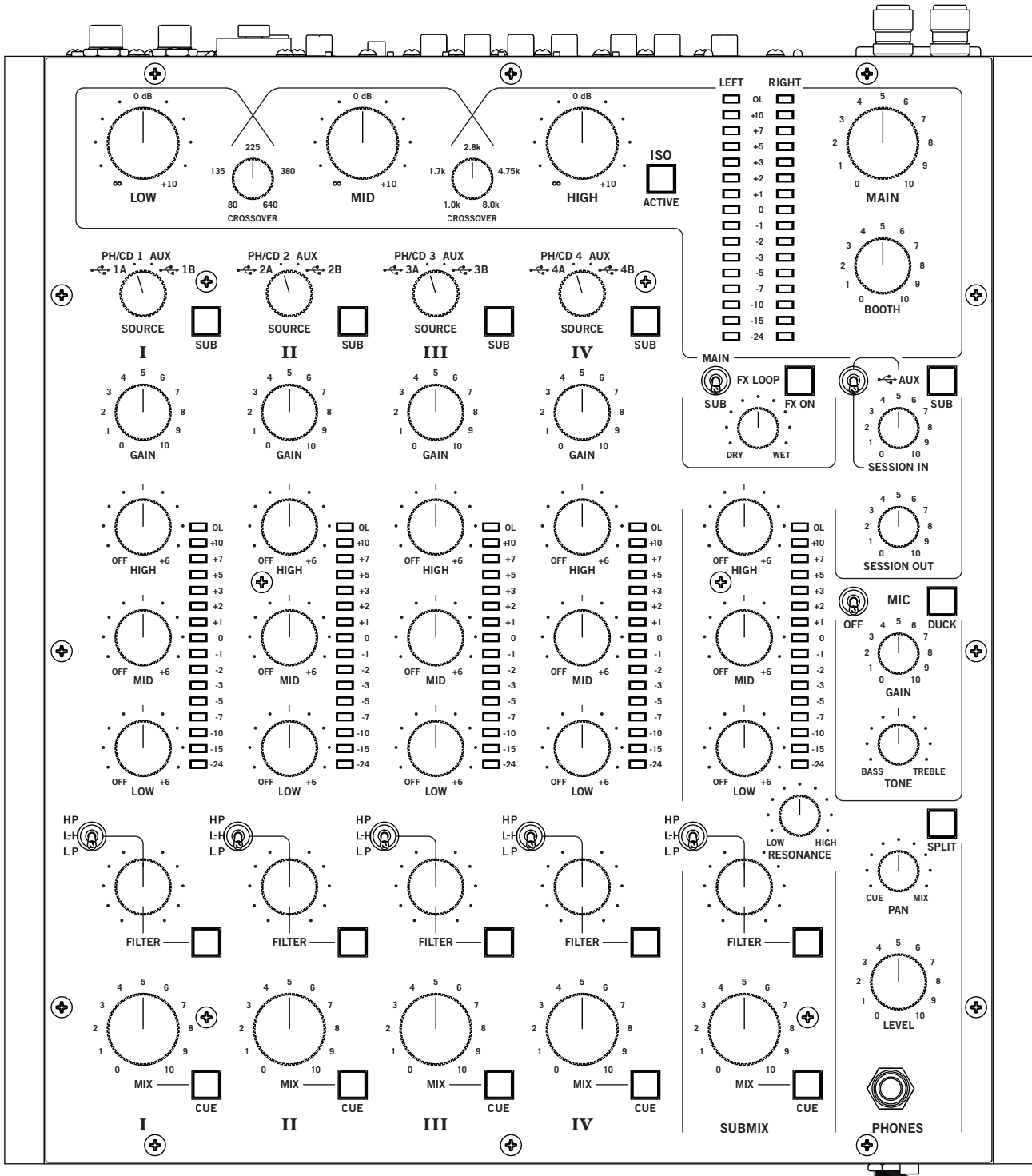

# Connections

## Mixer Inputs

- One stereo Phono / CD input is provided for each of the four channels on a red and white pair of RCA jacks. If your CD players have S/PDIF outputs, connect these to the orange S/PDIF inputs. Each channel may be set for PH, CD or SP using rear panel slide switches. Set unused inputs to CD. Connect your turntable ground wires to the ground posts provided on the rear panel when using PH inputs.
  - Computer control panel: Phono Sensitivity adjustment to match source levels. See "Control Panel" on page 16.
- There is one stereo unbalanced AUX IN on RCA jacks. This input may be selected by any of the four Deck channels.
- One stereo Session Input is available as analog on a pair of red and white RCA jacks, or digitally using the orange S/PDIF jack. Select the input type with the LINE / S/PDIF switch. Use this input to connect two mixers together. Using S/PDIF Session Input with another mixer's S/PDIF Session Output can digitally link mixers without converting to analog.
  - This input may also be a general purpose auxiliary input to the mixer, assigned to the Main mix or Submix. If it's assigned to the Submix, it can be a 5th input with it's own tone and filter controls like the first 4 channels.
- The balanced microphone input on a combination TRS / XLR jack can be switched to:
  - LINE level for the output of a wireless mic receiver.
  - MIC level for a regular dynamic microphone.
  - +48 V Phantom power for a condenser microphone.
- Stereo FX Loop Return input is on a pair of unbalanced RCA jacks. The FX Return input is normally used in combination with the FlexFX Send output to connect an outboard effects processor.

## Mixer Outputs

All of these outputs carry the same Main mix signal, each with its own Level control:

- MAIN Output is on a pair of balanced XLR jacks.
- BOOTH Output is on a pair of balanced 1/4" TRS jacks.
- SESSION Out is on a pair of unbalanced RCA jacks, and digitally via S/PDIF on an RCA jack.

The FX Loop Send output is available on a pair of unbalanced RCA jacks. The FlexFX Send output is normally used in combination with the FlexFX Loop Return input to connect outboard analog effects. The Main mix is sent to effects.

- The SEND output level can be switched to -10 (for unbalanced devices) or +4 (for balanced devices).

**Cabling Note:** When using unbalanced 1/4" tip-sleeve cables from the Booth Outputs, or RCA cables from the analog Session Outputs, keep cables short, less than 3 meters (10 feet) to avoid hum and interference. Balanced 1/4" TRS or XLR cables are the best choice, allowing greater distance runs without problems.

## Two USB Ports

The MP2015 allows simultaneous connection of two computers, each port completely independent. The USB ports are 100% class compliant, allowing hook-up to Mac OSX without the need for an additional driver. A high-performance ASIO driver connects the audio in most Windows DAW and DJ software. MIDI end points are class compliant with both OSX and Windows devices. Connect either port to a single computer. See "Class Compliant USB Ports" on page 16.

## Power Supply

The MP2015 Mixer features an internal universal switching power supply that operates on any AC mains 100 to 240 VAC, 50 or 60 Hz (most places in the world). All that is required when traveling is the appropriate IEC line cord, available from a local electronics store. The universal supply is a major plus for the traveling DJ. Though this mixer has turn on/off muting, it's smart to leave the power unplugged until everything else is connected.

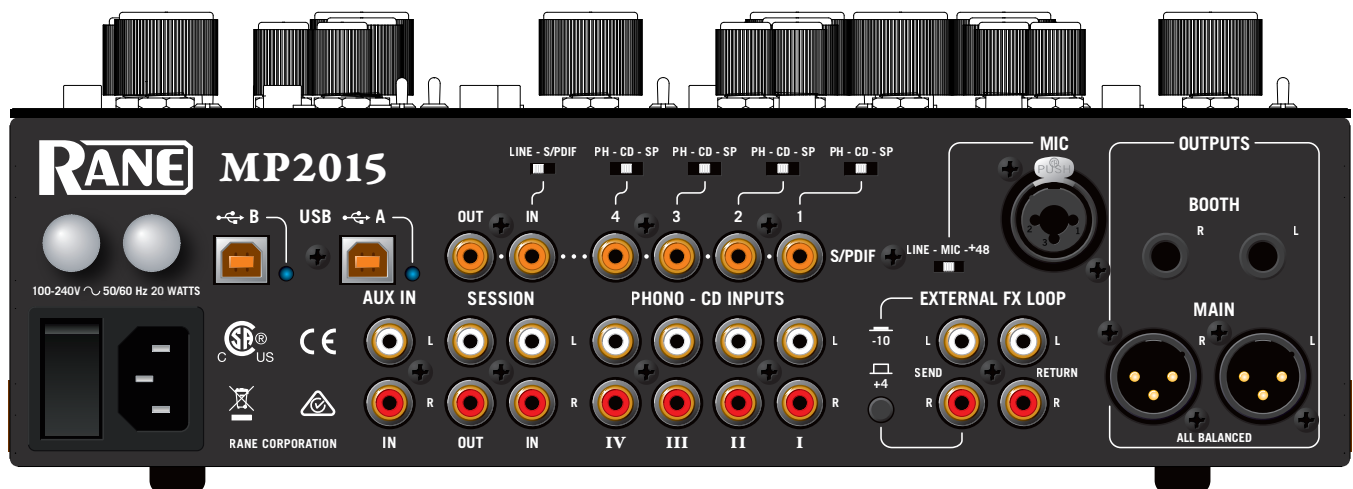

# Deck Input Channels

## Source Selectors

The source selectors choose the active USB port, USB audio slot or analog input for each input channel. To use USB playback you must assign the USB slots in your DJ or DAW software preferences panel.

Deck 1 Source Selections	Deck 2 Source Selections	Deck 3 Source Selections	Deck 4 Source Selections
<p><b>Port A playback for Deck 1</b></p> <ul style="list-style-type: none"> <li>• USB audio slots 1-2.</li> <li>• Routes audio and MIDI for Deck 1 only to/from USB Port A.</li> </ul>	<p><b>Port A playback for Deck 2</b></p> <ul style="list-style-type: none"> <li>• USB audio slots 3-4.</li> <li>• Routes audio and MIDI for Deck 2 only to/from USB Port A.</li> </ul>	<p><b>Port A playback for Deck 3</b></p> <ul style="list-style-type: none"> <li>• USB audio slots 5-6.</li> <li>• Routes audio and MIDI for Deck 3 only to/from USB Port A.</li> </ul>	<p><b>Port A playback for Deck 4</b></p> <ul style="list-style-type: none"> <li>• USB audio slots 7-8.</li> <li>• Routes audio and MIDI for Deck 4 only to/from USB Port A.</li> </ul>
<p><b>Phono / CD 1</b></p> <ul style="list-style-type: none"> <li>• Set the PH-CD-SP switch on the rear panel.</li> </ul>	<p><b>Phono / CD 2</b></p> <ul style="list-style-type: none"> <li>• Set the PH-CD-SP switch on the rear panel.</li> </ul>	<p><b>Phono / CD 3</b></p> <ul style="list-style-type: none"> <li>• Set the PH-CD-SP switch on the rear panel.</li> </ul>	<p><b>Phono / CD 4</b></p> <ul style="list-style-type: none"> <li>• Set the PH-CD-SP switch on the rear panel.</li> </ul>
<p>• <b>Aux Input</b> (common to all selectors).</p>			
<p><b>Port B playback for Deck 1</b></p> <ul style="list-style-type: none"> <li>• USB audio slots 1-2.</li> <li>• Routes audio and MIDI for Deck 1 only to/from USB Port B.</li> </ul>	<p><b>Port B playback for Deck 2</b></p> <ul style="list-style-type: none"> <li>• USB audio slots 3-4.</li> <li>• Routes audio and MIDI for Deck 2 only to/from USB Port B.</li> </ul>	<p><b>Port B playback for Deck 3</b></p> <ul style="list-style-type: none"> <li>• USB audio slots 5-6.</li> <li>• Routes audio and MIDI for Deck 3 only to/from USB Port B.</li> </ul>	<p><b>Port B playback for Deck 4</b></p> <ul style="list-style-type: none"> <li>• USB audio slots 7-8.</li> <li>• Routes audio and MIDI for Deck 4 only to/from USB Port B.</li> </ul>

For details on sharing the MP2015 with a second computer, see "DJ Changeover" on page 15.

### Deck Source Selection is followed by:

- GAIN trim
  - Off to +15 dB with unity gain at 12 o'clock.
- 3-band HIGH / MID / LOW tone controls
  - Off to +6 dB with unity gain at 12 o'clock.
  - Linkwitz-Riley 2nd-order isolator full-cut filters (LR-2).
  - Crossover points for Low/Mid and Mid/High default at 300 Hz between Low and Mid, 3 kHz between Mid and High. This can be changed for each Deck. See "Control Panel" on page 16.
- High-Pass / Low-High-Pass / Low-Pass Sweep FILTER
  - LP: Low-pass filter cutoff moves from 20 kHz toward 20 Hz as the knob is turned CCW.
  - HP: High-pass filter cutoff moves from 20 Hz toward 20 kHz as the knob is turned CW.
  - L-H: In Low-High mode, there is no effect at the center (flat response).
    - Low-pass increases CCW from the center.
    - High-pass increases CW from the center.
  - Resonance can be adjusted for all Sweep Filters with the RESONANCE control.
- CUE select
  - Assigns a Deck to the headphone monitor.
- Q-peak meter with peak hold
  - Adjust the GAIN trim to get the signal into the yellow during peaks, and to prevent overload.
- MIX control
  - Adjusts the channel level feeding the USB record outputs, Submix or Main mix.
- Submix
  - When the SUB button (next to the Source selector) is pressed and lit blue, the Deck is sent to the Submix. When this button is off, the channel is sent to the Main Mix. See "Submix" on page 10. See "Main Mix Outputs" on page 13.

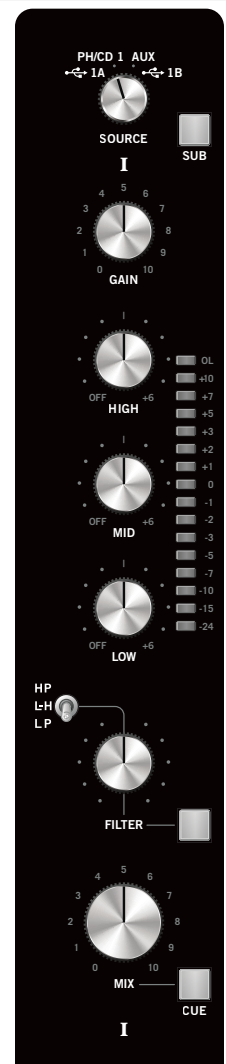

## Session Input and Output

Session input sources may be unbalanced RCA, digital S/PDIF, or USB audio channels 9/10. Session input can be used independently to provide an additional stereo input to the mixer, or in conjunction with Session Out to chain mixers together.

Connect any line-level device (e.g., a CD player, another DJ mixer, an iPod, iPhone, etc.) to the Session In RCA white and red jacks. The orange S/PDIF input connects a digital device (e.g., a CDJ 2000 or another MP2015 mixer) using a single RCA cable. Use the switch above the jacks to select the S/PDIF input or the RCA inputs as a source. Alternatively, USB Aux audio channels 9/10 can be selected as the Session input source using the toggle switch next to the Session In level control.

Session Output is available on unbalanced analog white and red RCA jacks and an orange digital S/PDIF jack. These outputs can be used for auxiliary zone output, in combination with Session Input when chaining mixers together or for external digital S/PDIF main mix recording. Both of these outputs are active at the same time.

Note: Using S/PDIF provides better sound and higher performance when connecting an available S/PIDF source like an equipped CDJ or another mixer.

To play audio coming from a device plugged into the RCA or S/PDIF Session Inputs, set the USB AUX toggle switch to SESSION IN (down position). To play audio from USB audio channels 9/10 set the USB AUX switch to USB AUX (up position). To use USB AUX playback, you must assign USB channels 9/10 in your DJ or DAW software preferences panel.

Assigning the Session Input to the Submix (press the SUB button) essentially turns this 4-channel mixer into a full-featured 5-channel mixer with the Submix channel providing independent 3-band EQ, Filter, Mix Level and Cue.

You can simultaneously record the Session Input, channels 1, 2, 3, 4, Submix, and the Main output through USB audio channels. Multitrack recording allows you to “fix” a recording in the studio. See "USB Audio" on page 14.

The Session Out control affects the level of audio output on the Session Out RCA jacks, S/PDIF jack and USB Record channels 13-14.

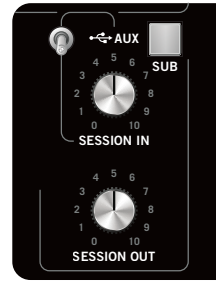

### Real World Session I/O Application

If you are a Traktor and Maschine user, you may typically use a combination of four track decks and/or remix decks within Traktor as well as hits, loops, and samples coming from Maschine.

Route your four tracks/remix decks to the four channels on the MP2015 and then route the main output of Maschine through the Session Input via USB AUX channels 9/10. Set the audio routing in the Traktor Preferences.

Use the Session In gain to control the audio volume coming from Maschine. You can send the audio from Maschine to the Submix by pressing the Session In SUB button, giving you full Mix level, EQ, and Filtering. Alternatively, you can take advantage of Maschine's discrete audio through the Deck channels to the Submix for ease of multi-source mixing and/or to add an external effect.

## Submix

The Submix is a channel that you can send any or all audio to, just as you do with the main mix. The Submix may include any combination of the four Deck Inputs and the Session Input. Press the SUB button on any Deck or the Session In to assign it to the Submix, lighting the button blue. This allows grouping any number of inputs for easy and intuitive multi-source mixing. The concept is identical to a Submix or bus track on a typical audio mixing console. This capability is important for grouping a number of tracks together onto one channel for ease of control and processing.

- Channels assigned to the Sub Mix share a common set of controls:
  - Main MIX Level.
  - 3-band full-cut tone controls. Crossover points for Low/Mid and Mid/High can be changed. See "Control Panel" on page 16.
  - 16-segment Q-peak meter with peak hold.
  - Headphone CUE.
  - Selectable High-Pass / Low-High-Pass / Low-Pass Sweep FILTER.
    - Note: The Resonance control affects all Sweep Filters for Decks 1, 2, 3, 4 and the Submix.
- Assignable external Effects Loop:
  - The FX Send level can be switched on the rear panel to -10 (for low-voltage devices) or +4 (for higher-voltage devices).
  - FX ON button activates the effects loop when lit, receiving input from the FX RETURN jacks.
  - Wet / Dry controls the ratio of FX to the mix.
  - This Loop may be switched to process the Main Mix or the Submix.
- USB Record output for the Submix is on channels 11-12.

## Why add a Submix to a DJ mixer?

One huge leap forward in DJ technology is the introduction of auto sync. Using CDJs, Traktor, Virtual DJ, Ableton, or most any DJ software, the sync feature opens the gates to creative multi-source mixing. New technology offers new possibilities, and might make you rethink how you mix. A Submix removes the burden of having to simultaneously manage separate gain, EQ, and filter controls for multiple channels when mixing multiple sources. Grouping the tracks together within the Submix allows one simple set of controls to easily control Mix level, EQ and Filter settings for multiple channels, turning one control instead of 2, 3 or 4 all at once.

When mixing two sources, you probably won't use the Submix, unless you want to add an external effect to one or both of the channels. The Submix is key for DJs needing to easily and intuitively mix multiple sources at once.

## Using the Submix

Let's look at an example with three sources of audio coming from software:

- The main track is on channel 1, a drum loop on channel 2, and a looped sample on channel 3.
- There is a breakdown coming up in the main track and you want to filter out the Low/Mid range while turning down the gain of the tracks on channels 2 and 3 going into the breakdown.
- Before assigning channels to the Submix, make certain that doing so initially has a neutral affect on what is being played. Turn the Submix Mix control all the way up, set the tone controls at 12 o'clock, and turn off the Filter within the Submix channel. This ensures that the audio sent to the Submix is initially unaffected by the Submix routing.
- Press the SUB buttons next to the Source selector on both channels 2 and 3. This sends the audio of both channels to the Submix.
- Now you can control both tracks on channels 2 and 3 using the Submix control strip.
- As you get closer to the breakdown about to happen on the channel 1 track:
  - Turn on the Filter within the Submix channel.
  - Start filtering out the Low and Mid range frequencies with the Filter control.
  - Turn down the level of both tracks with the MIX knob in the Submix.

Mix successfully executed!

Without a Submix, you would need to turn on two Filters, adjust two Filter controls and turn down two Mix controls to execute the same mix. Adding more tracks to the mix makes this process even harder to manage and could land in a sea of uncontrolled sound and a confused dance floor.

## Submix and the External FX Loop

The Submix features an external effects insert, allowing you to add effects to assigned channels. The external FX controls are located at the top of the Submix channel strip:

1. FX ON button: sends and returns audio from an outboard effects processor.
2. MAIN / SUB switch: allows you to choose whether you want to add an effect to audio coming into the Submix or to the Main mix.
3. WET / DRY: controls the amount of the effect.

You'll find the RCA Send and Return jacks and a level switch on the rear panel. Here's how it works:

1. Connect the MP2015 SEND to the input of your external effects processor.
2. Connect the output of the effects processor to the MP2015 RETURN.
  - a. If you use a consumer-grade effects processor, such as the Korg Kaoss Pad, engage the -10 switch by pressing it in. This matches the I/O level of the external effects processor to the MP2015.
3. Select SUB or MAIN mix as the location for the effects insert:
  - If you want the effect on everything, select MAIN.
  - If you want the effect only on the Submix selected inputs, select SUB.
  - a. For the Main mix, set the effects assign toggle to MAIN then simply press the FX ON button to engage the FX Loop and rotate the control toward WET until you hear the desired effect amount.
  - b. To apply an effect to channels assigned to the Submix, set the FX Loop assign to SUB. Send the desired channels to the Submix. Turn the FX ON and adjust WET / DRY as desired.
  - c. To avoid any change in your mix when sending channels to the Submix, make sure the MIX knob in the Submix is turned all the way up, the tone controls are dead center at 12 o'clock, and the FILTER switch is turned off.

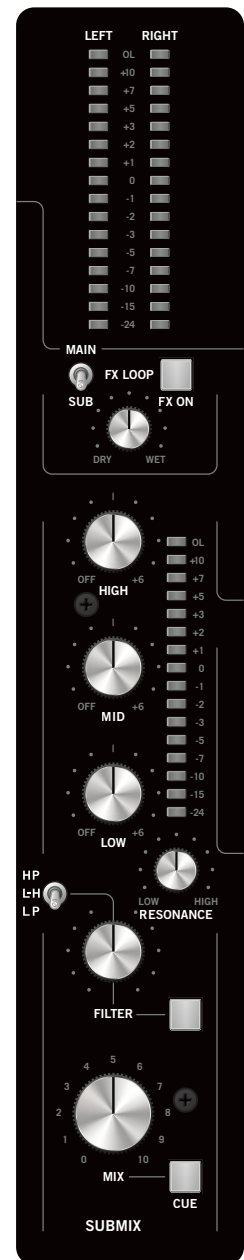

## Submix Signal Flow

Starting from the Source selectors, the signal passes through the Gain, Tone, Filter and Mix controls. This graphic has the SUB buttons, Session In and FX control positions re-arranged to more easily see the signal flow.

- If SUB is not pressed (see Decks 1 and 2) then the signal goes to the FX Loop (if it's on), then the ISO EQ (if it's on), then to the Main Outputs.
- If SUB is pressed (see Decks 3, 4, and Session In) then the signals are combined and go through another set of Tone, Filter and Mix controls. From here, the Submix can go through the FX Loop (if it's on), then the ISO EQ (if it's on), then to the Main Outputs.

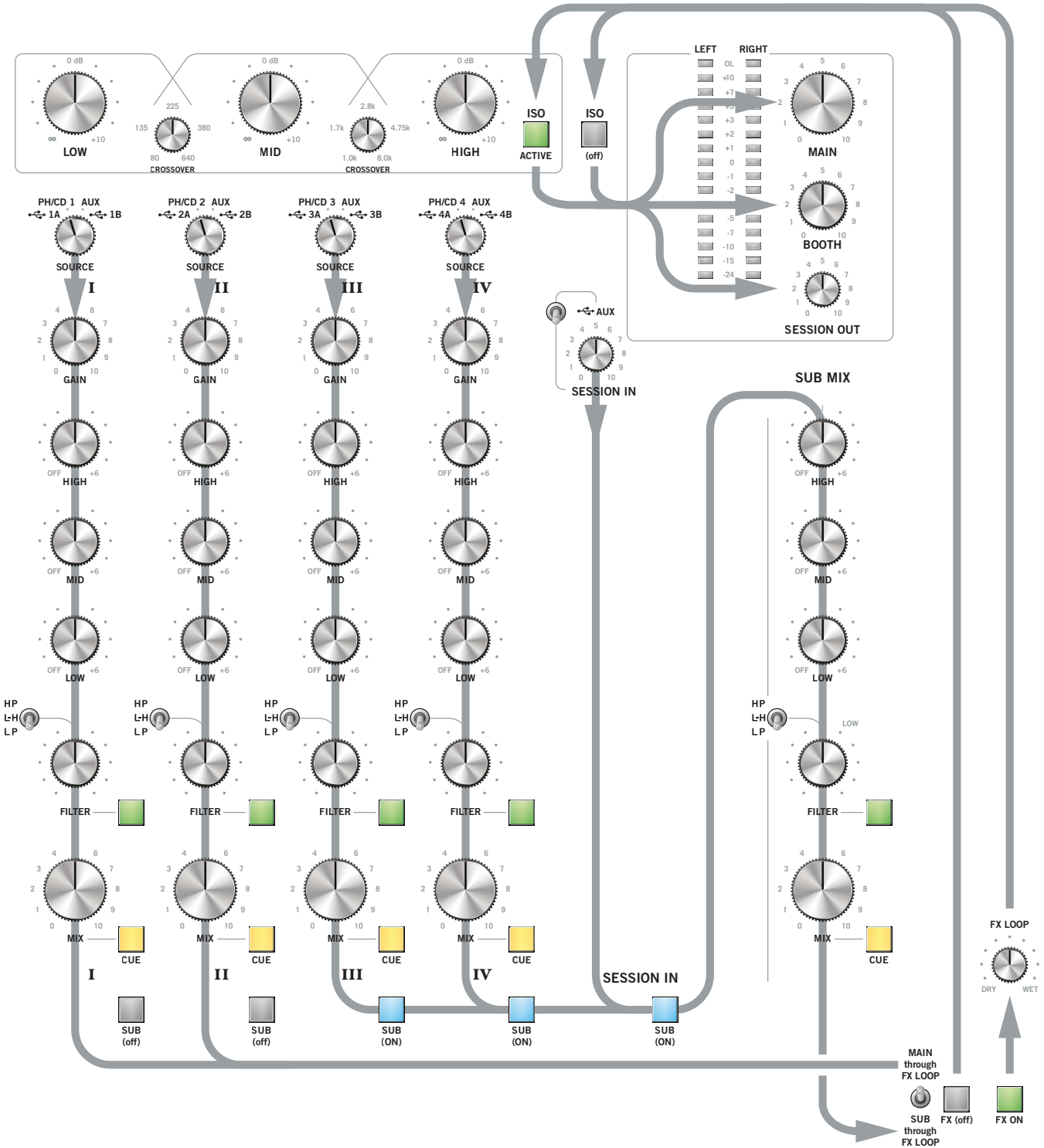

## Microphone Input

The mic input has these controls:

- On / Off switch turns the mic on or off.
- Duck momentarily ducks other inputs by 10 dB (by about 1/3).
- Gain control sets the mic level.
- One-knob spectral tilt Tone control:
  - Increasing highs reduces lows by the same amount.
  - Decreasing highs increases lows by the same amount.
- A rear panel switch has 3 positions for different mic types:
  - Line level accepts the output from a wireless mic receiver.
  - Mic level is suitable for a dynamic mic.
  - 48V phantom power is for a condenser mic.
- Control panel option: with Clean Feed selected, the Mic signal is sent directly to the Main Out and is not present in the USB Main Record, Booth Out or Session Out. See "Control Panel" on page 16.



## Headphone Cueing

- The Headphone monitor provides stereo or mono split cue operation.
  - When set for stereo operation (off), the Pan control pans between stereo Cue and stereo Main Mix.
  - When set for Split Cue operation (ON), the Pan control pans between Mono Cue in the left ear and mono Main Mix in the right ear.
- Individual Cue buttons are provided for Deck 1, Deck 2, Deck 3, Deck 4, and Submix.
- Cue buttons engage headphone monitoring for each channel. Multiple channels can be cued simultaneously by pressing the Cue for each.
- The Phones control sets the level to the headphone jacks.
- Headphones output is available on two 1/4" jacks, one on the front and one on the top. An additional 3.5 mm jack is located on the front. All share the same signal.
- The Control Panel allows Bass and Treble adjustment in headphones. See "Control Panel" on page 16.
  - Note: the Main Output Isolator is not heard in the headphones.

## Main Mix Outputs

- These signals combine to make the Main Mix signal:
  - Decks 1, 2, 3, and 4.
  - Session In.
  - Submix / FX Return.
  - Mic.
- Main Mix outputs are:
  - Main: balanced XLR jacks with a maximum output of 8 volts rms.
  - Booth: balanced 1/4" TRS jacks with a maximum output of 8 volts rms.
  - Session: unbalanced RCA jacks with a maximum output of 4 volts rms.
    - S/PDIF digital session output on one RCA jack.
- Common to all Main Mix outputs:
  - Stereo Q-peak meter with peak hold:
    - If the red overload LED is off, the mixer will not clip at any output level setting.
  - Main Output Isolator:
    - Off to +10 dB with unity gain at 12 o'clock.
    - Low-mid crossover is adjustable from 80 Hz to 640 Hz.
    - Mid-high crossover is adjustable from 1 kHz to 8 kHz.
- Main, Booth and Session outputs have independent Level controls; their range is off to 0 dB.
- Control panel option: the Main Output can be set to Mono or Stereo. Other outputs remain in stereo. See "Control Panel" on page 16.

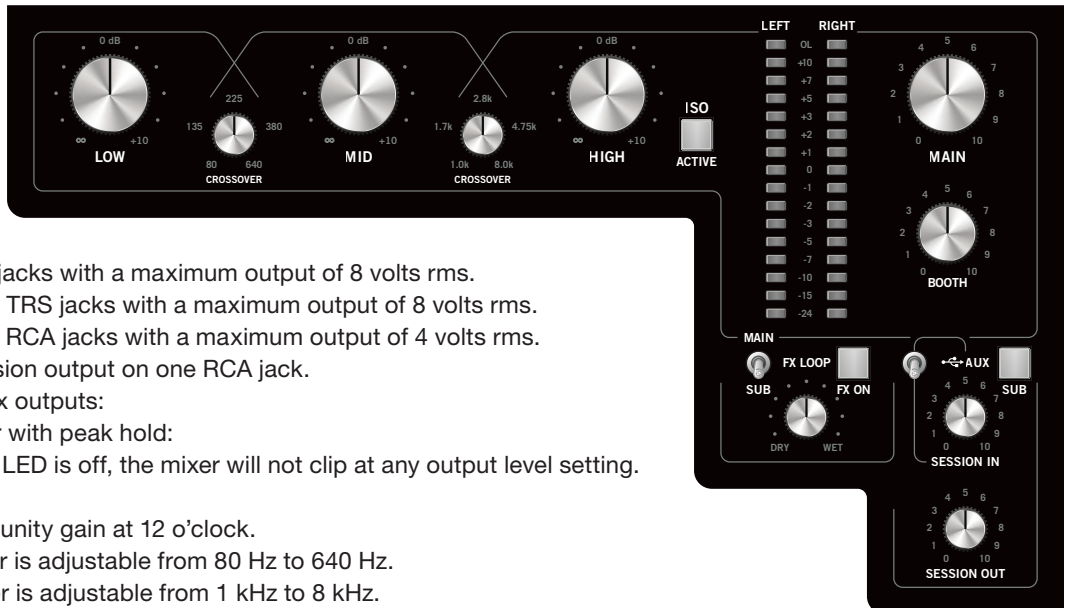

# USB Audio

There are seven stereo record channels and five stereo playback channels. These channels are available on two USB ports, allowing two computers to share the device. This allows two DJs to play together, and supports uninterrupted transitions between them. USB audio is 24-bit PCM with a sample rate of 44.1, 48 or 96 kHz. Sample rate and USB slot assignments are made in the preferences screen in your DJ or digital audio workstation software.

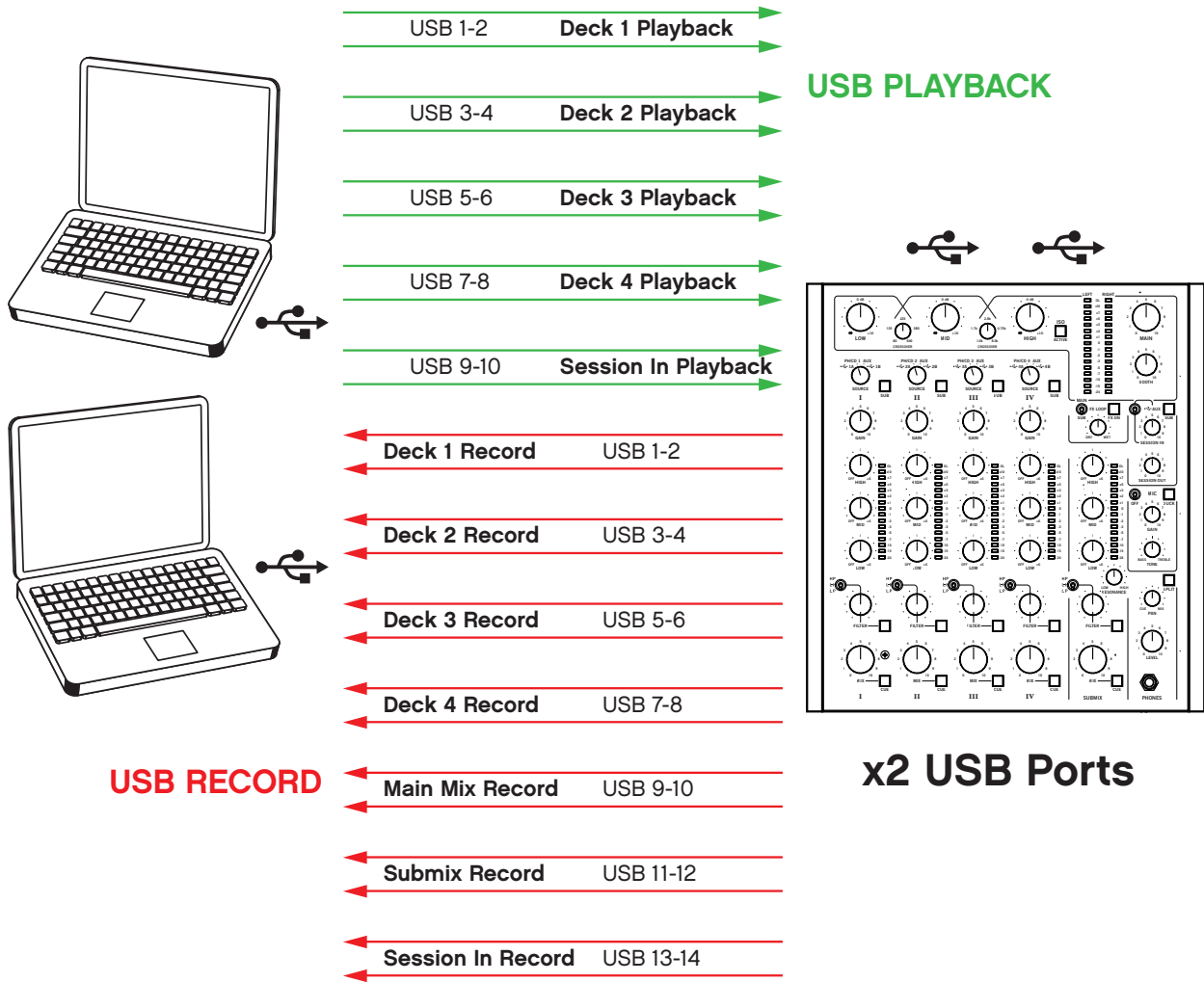

## USB Playback Channels Assignment

Deck 1 Playback	Deck 2 Playback	Deck 3 Playback	Deck 4 Playback	Session In USB Playback
In USB audio playback slots 1-2.	In USB audio playback slots 3-4.	In USB audio playback slots 5-6.	In USB audio playback slots 7-8.	In USB audio playback slots 9-10.
Routed from either USB A or USB B depending on the Deck Input source selection.				Sum of USB A and USB B.

## USB Record Channel Assignment (Broadcast to both USB A and USB B at all times).

Deck 1 Record	Deck 2 Record	Deck 3 Record	Deck 4 Record	Main Mix Record	Submix Record	Session In Record
In USB audio record slots 1-2.	In USB audio record slots 3-4.	In USB audio record slots 5-6.	In USB audio record slots 7-8.	In USB audio record slots 9-10.	In USB audio record slots 11-12.	In USB audio record slots 13-14.
Select "Phono / CDJ" for DVS. Select "Post" for multi-track recording (default). See "Control Panel" on page 16.						

## DJ Changeover

One of the biggest challenges of digital DJing has been seamlessly changing over from one DJ to the next and playing back-to-back DJ sets. With the dual USB architecture of the MP2015 mixer, changeover between digital DJs has never been easier.

### Deck Changeover Controls

At the top of each input channel is the Source Selector to switch input sources. If your computer is connected to USB port A, switch a channel Source Select knob to USB A, and the mixer assigns the corresponding virtual deck to that channel for audio playback. For example, assigning all four channels to USB 1A-4A assigns all four virtual decks to the computer connected to USB port A.

The same applies to USB port B. If your computer is connected to USB port B, switching a channel Source Select knob to USB B, assigns the corresponding virtual deck to that channel for audio playback.

When two DJs are connected to the MP2015, they can quickly swap deck control between computers using the Source Select knobs. Any of the four inputs can be swapped back and forth with a simple knob twist. Nice and easy, just the way we intended.

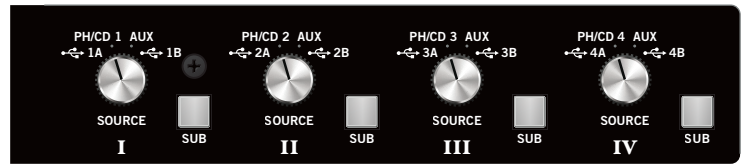

### The DJ Changeover Walkthrough

In the scenario below, one DJ, let's call him DJ A, is already connected to the MP2015 using either USB port A or B. With DJ A's computer already connected and playing music, do the following:

1. Connect your computer to the unused USB port on the MP2015.
2. Switch the Input Source on a non-playing input channel to the USB source of your computer.
3. Play a track on this Deck and mix it in when you're ready — audio from both computers are in the mix.
4. Fade out the audio playing from DJ A's computer to the audio playing from your computer.
5. Assign the Input Source for the remaining free mixer channel(s) to your computer and continue DJing.

When DJ A is done, disconnect his computer from the USB port. If you're back-to-back mixing with DJ A, keep the computer connected and perform the same swapping instructions to regain deck control.

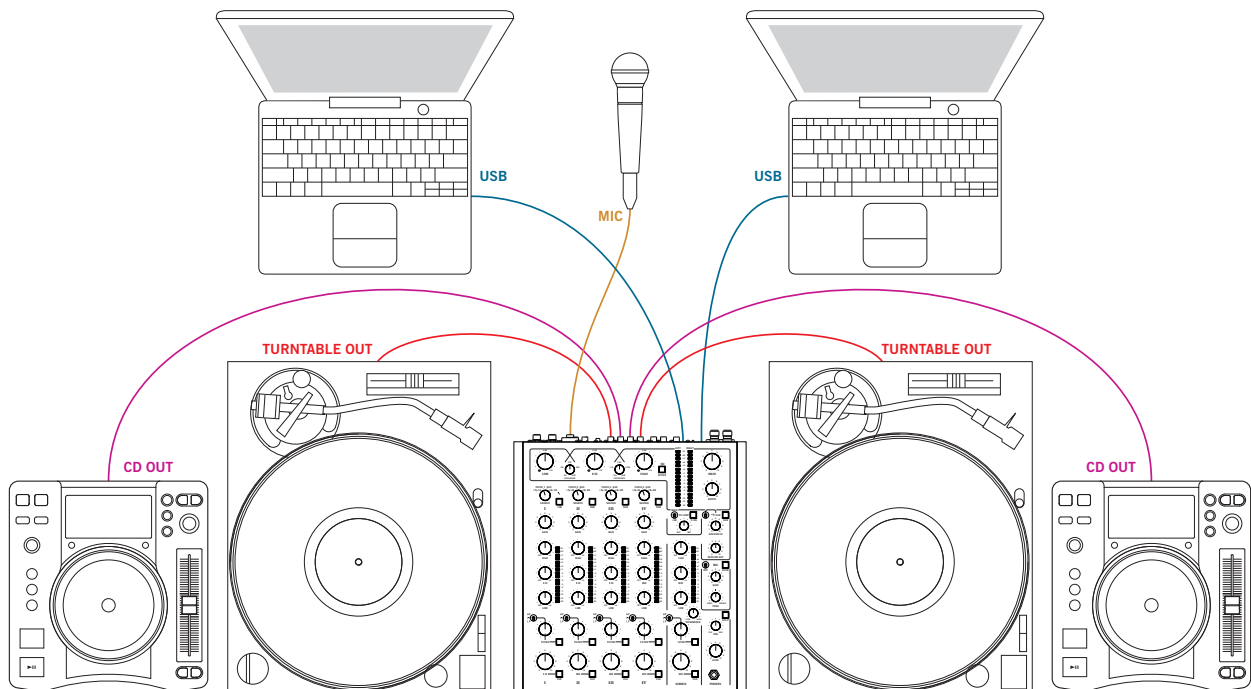

## Class Compliant USB Ports

The USB ports are 100% class compliant, connecting to Mac OSX without the need for an additional driver. A high-performance ASIO driver runs most Windows DAW and DJ software. MIDI end points are class compliant with both OSX and Windows devices. Mac and Windows Control Panel installers with additional mixer settings are included on the CD-ROM with the MP2015, and current versions available from the Downloads link in the MP2015 page at [dj.rane.com](http://dj.rane.com).

### ASIO (Windows)

A low-latency ASIO driver interfaces with most DJ and DAW audio software applications on Windows operating systems. Multi-client ASIO allows different audio software applications to simultaneously stream audio to and from the MP2015. If the same playback channel is selected in more than one application, the driver mixes the audio from the applications before streaming it to the device. ASIO driver and Rane Control Panel system requires Windows 7-SP1, Windows 8 or 8.1. The driver Control Panel may be launched from the Windows Control Panel. Select Start > Control Panel > Rane MP2015.

### Core Audio (Macintosh)

No driver installation is required. Connect the MP2015 to a Mac running OSX, and the MP2015 inputs and outputs become available in your audio program. Install the Rane control panel to provide additional setting as described below.

## Control Panel

**NOTE:** Settings are saved in the mixer. The control panel for Windows or Macintosh is updated with the mixer's settings. Therefore, when you connect to a different MP2015 Mixer, it's saved settings override your previous Control Panel settings.

**NOTE:** The Rane Control Panel and Firmware may be updated with new features over time. To get the most from your MP2015, occasionally check the Downloads link in the MP2015 page at [dj.rane.com](http://dj.rane.com).

### Settings

The MP2015 allows you to save and export settings. You can load your preferences when using a different MP2015 than your own, or putting things back after another DJ has used your mixer.

Once you have set control panel preferences, click **Export** to write these to a computer file. Click **Import** to load a .rms settings file. The control panel shows the current settings file loaded in the mixer. If any changes are made since the last import, [Modified] will appear after the filename along with a **Save** button, offering to save your changes as the new default.

### Firmware

The MP2015 Firmware Version currently installed in the MP2015 is shown. The **Downloads** link on the MP2015 page at [dj.rane.com](http://dj.rane.com) is the place to check if there is a control panel / firmware update. After downloading and installing, if the MP2015 firmware installed on your computer is newer than the firmware in your MP2015, an **Update Firmware** button is enabled. Pressing the button updates the MP2015 firmware to the new version.

### General Tab

**Main Out** can be set to Stereo or Mono. The Booth and Session Outputs are always in stereo.

**Headphone Tone** slider adjusts the tone going to the headphones using spectral tilt filters.

- Increasing Treble reduces lows by the same amount.
- Increasing Bass reduces highs by the same amount.

**Sub Tone Crossover** sets the crossover points of the 3-band Tone controls in the Submix to either:

- 300 Hz between Low and Mid, 3 kHz between Mid and High.
- 150 Hz between Low and Mid, 6 kHz between Mid and High (default).

**Mic Clean Feed** when selected, the microphone signal is only sent to the Main Out and is not present in the USB Main Record, Booth Out or Session Out. This allows you to record your set without any house announcements. Default is Off.

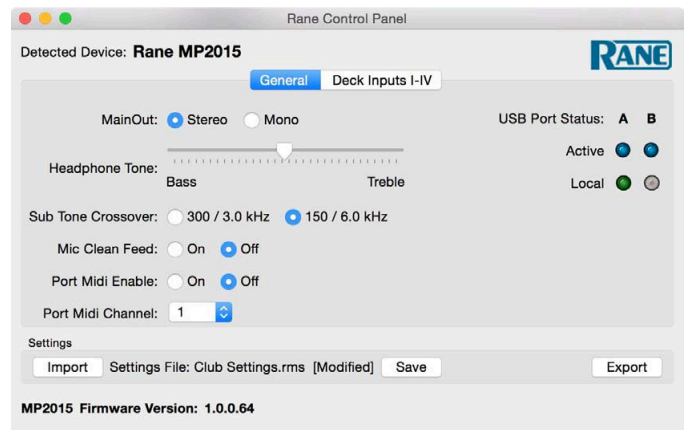

**Port MIDI Enable** enables MIDI commands to/from the MP2015 Mixer controls at the current USB Port. Default is Off.

**Port MIDI Channel** assigns MIDI channel 1-16 to the MP2015 Mixer at the current USB Port. Default is MIDI channel 1.

**USB Port Status** indicates the connection status of both USB ports. Active indicates a USB connection between the mixer and a computer. Local shows the USB Port connected to this control panel's computer.

The **Buffer Size** control allows the USB buffer to be increased or decreased. This only appears in the Rane Control Panel for ASIO in Windows. In Mac systems, the buffer control is in the DAW or DJ audio preferences screen and does not appear here. The Rane driver is designed to run at latencies as low as 5 milliseconds round-trip. However, computer performance and available resources (number of applications running) may adversely affect the computer's ability to stream audio reliably. If pops and clicks are heard in USB audio, try increasing the buffer size to eliminate them. With ASIO, total round-trip latency is equal to Buffer Size plus device latency. With Core Audio, total round-trip latency is determined by the Buffer Size set by the DAW/DJ software, plus device latency. Device latency is 3 to 4 ms.

## Deck Inputs I-IV Tab

There is one panel for each input channel on the mixer. Each Deck panel controls these functions:

**Analog Input Source:** The analog input for each Deck must be set appropriately for CD, Phono or S/PDIF using a switch on the rear of the mixer. The control panel shows the mode selected by these switches for each of the four inputs. This mode can only be changed on the mixer.

**Phono Sensitivity:** If a Phono Input is selected on the mixer (as shown for Decks I and IV), the Sensitivity adjustment appears in the panel. Click the down-arrow to display a list of 16 Sensitivity settings between 2.5 mV and 10 mV in 0.5 mV steps. The default is 5 mV. Set the Phono Sensitivity to the same level of your cartridge (see your cartridge documentation for the correct value). Another method is to match the level of the turntable to a CD playing on another input.

**USB Record Source:** These controls select one of two sources for each input channel as the USB record source.

- Phono / CD will record the source pre-Mix control, used for DVS applications.
- Deck (1-4) Post records each deck after the Mix control, used for multitrack recording. Each Deck records to separate USB slots. This is the default setting. See "USB Audio" on page 14.

**Tone Crossover** sets the crossover points of the 3-band Tone controls for each of the Deck channels to either:

- 300 Hz between Low and Mid, 3 kHz between Mid and High.
- 150 Hz between Low and Mid, 6 kHz between Mid and High (default).

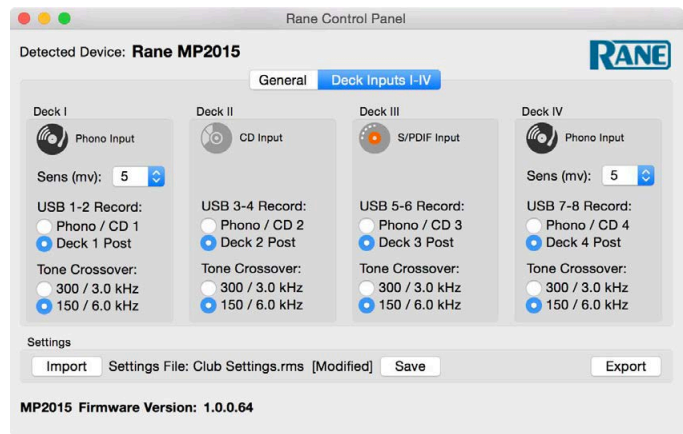

# MIDI Mapping

Top Panel MIDI Controls (blue = CC#, red = Note#)

The diagram illustrates the MIDI mapping for the top panel of the Rane MP2015 mixer. Controls are categorized as follows:

- Crossover:** 2 (LOW), 9 (CROSSOVER), 10 (MID), 17 (CROSSOVER), 24 (HIGH)
- Source:** 57 (PH/CD 1 AUX), 54 (PH/CD 2 AUX), 50 (PH/CD 3 AUX), 45 (PH/CD 4 AUX)
- Gain:** 1, 8, 16, 23
- EQ:** 3, 5, 7, 11, 13, 15, 18, 20, 22, 25, 27, 29, 32, 34, 36
- FX:** 5 (FX LOOP), 7 (FX ON), 30 (DRY/WET)
- Session:** 37 (SESSION IN), 38 (BOOTH), 39 (MAIN), 40 (SESSION OUT)
- Filter:** 6, 14, 21, 28, 35
- Mix:** 4, 12, 19, 26, 33
- Tones:** 42 (GAIN), 44 (TONE)
- Vertical Stack (Right):** 41 (LEVEL), 43 (PAN), 9 (SPLIT), PHONES
- Submix (Bottom Right):** 31 (RESONANCE), 13 (CUE), 35 (FILTER)

## Rear Panel MIDI Controls

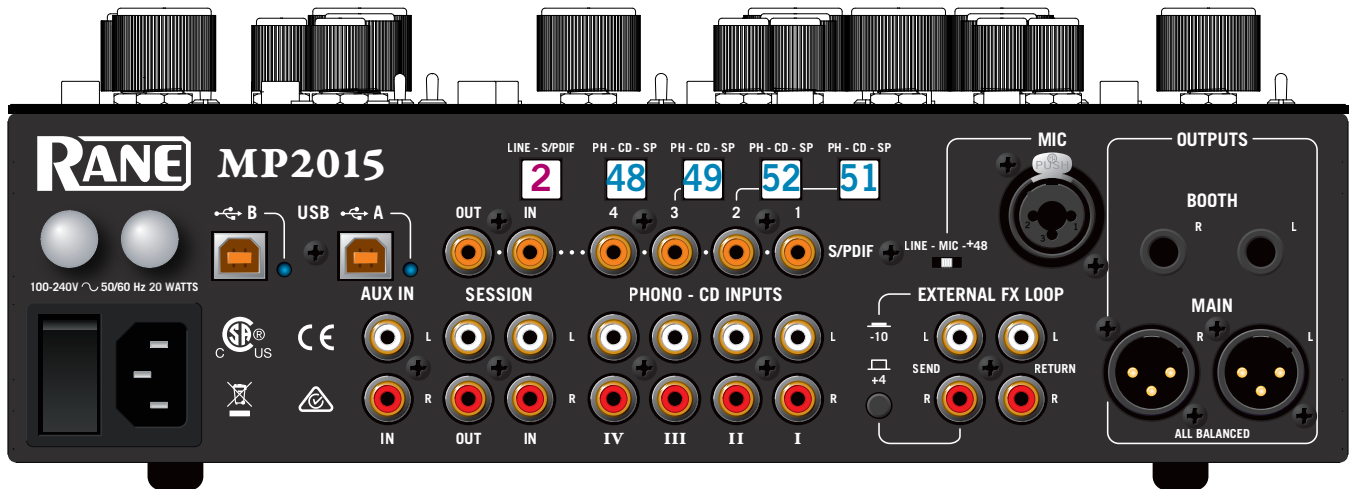

## Control Panel MIDI Controls

Control change numbers for items in the mixer menus are shared with corresponding controls in the driver control panel.

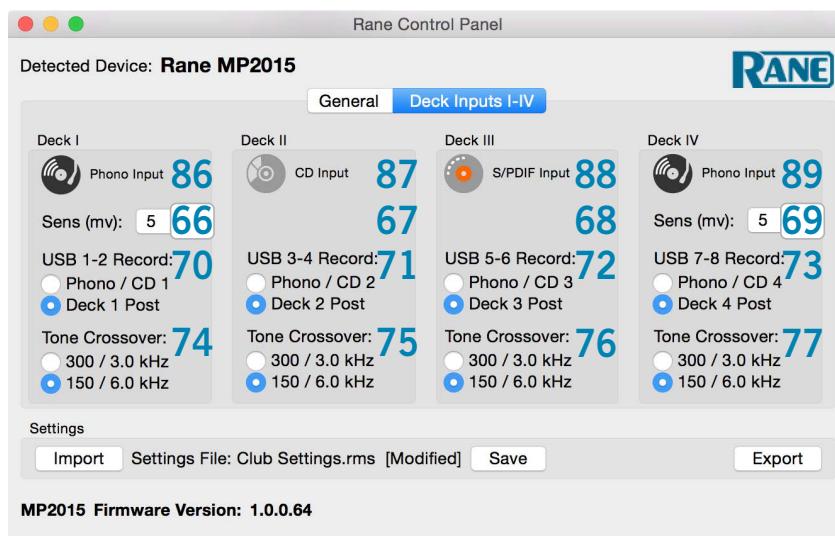
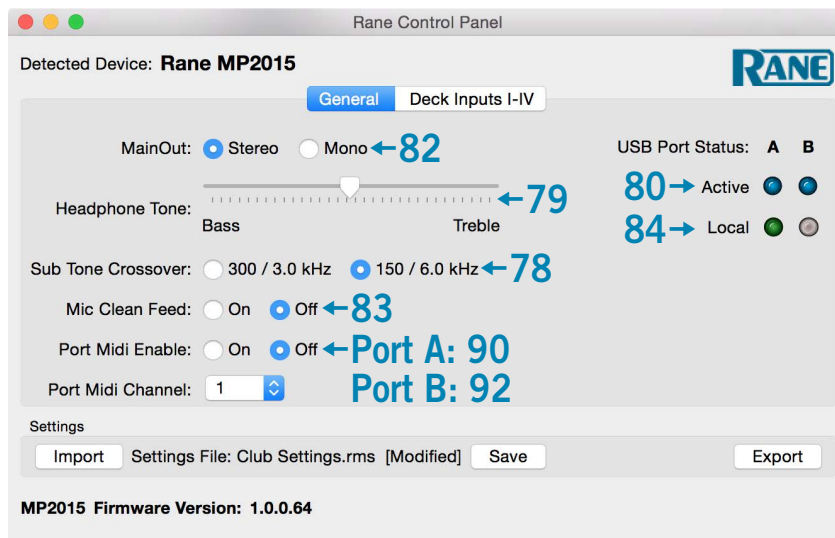

# MIDI Implementation

## Top Panel MIDI Control Change Chart

Control # Dec	Control # Hex	Function	Value
1	1	Deck 1 Input Gain Trim	0-127 (0x00-0x7F)
2	2	Isolator EQ Low Boost/Cut	0-127 (0x00-0x7F)
3	3	Deck 1 High Boost/Cut	0-127 (0x00-0x7F)
4	4	Deck 1 Mix Level	0-127 (0x00-0x7F)
5	5	Deck 1 Mid Boost/Cut	0-127 (0x00-0x7F)
6	6	Deck 1 LP/HP Filter	0-127 (0x00-0x7F)
7	7	Deck 1 Low Boost/Cut	0-127 (0x00-0x7F)
8	8	Deck 2 Input Gain Trim	0-127 (0x00-0x7F)
9	9	Isolator Low/Mid Crossover	0-127 (0x00-0x7F)
10	0A	Isolator Mid Boost/Cut	0-127 (0x00-0x7F)
11	0B	Deck 2 High Boost/Cut	0-127 (0x00-0x7F)
12	0C	Deck 2 Mix Level	0-127 (0x00-0x7F)
13	0D	Deck 2 Mid Boost/Cut	0-127 (0x00-0x7F)
14	0E	Deck 2 LP/HP Filter	0-127 (0x00-0x7F)
15	0F	Deck 2 Low Boost/Cut	0-127 (0x00-0x7F)
16	10	Deck 3 Input Gain Trim	0-127 (0x00-0x7F)
17	11	Isolator Mid/High Crossover	0-127 (0x00-0x7F)
18	12	Deck 3 High Boost/Cut	0-127 (0x00-0x7F)
19	13	Deck 3 Mix Level	0-127 (0x00-0x7F)
20	14	Deck 3 Mid Boost/Cut	0-127 (0x00-0x7F)
21	15	Deck 3 LP/HP Filter	0-127 (0x00-0x7F)
22	16	Deck 3 Low Boost/Cut	0-127 (0x00-0x7F)
23	17	Deck 4 Input Gain Trim	0-127 (0x00-0x7F)
24	18	Isolator High Boost/Cut	0-127 (0x00-0x7F)
25	19	Deck 4 High Boost/Cut	0-127 (0x00-0x7F)
26	1A	Deck 4 Mix Level	0-127 (0x00-0x7F)
27	1B	Deck 4 Mid Boost/Cut	0-127 (0x00-0x7F)
28	1C	Deck 4 LP/HP Filter	0-127 (0x00-0x7F)
29	1D	Deck 4 Low Boost/Cut	0-127 (0x00-0x7F)
30	1E	FX Loop Wet/Dry Pan	0-127 (0x00-0x7F)
31	1F	LP/HP Filter Resonance	0-127 (0x00-0x7F)
32	20	Submix High Boost/Cut	0-127 (0x00-0x7F)
33	21	Submix Mix Level	0-127 (0x00-0x7F)
34	22	Submix Mid Boost/Cut	0-127 (0x00-0x7F)
35	23	Submix LP/HP Filter	0-127 (0x00-0x7F)
36	24	Submix Low Boost/Cut	0-127 (0x00-0x7F)
37	25	Session In Level	0-127 (0x00-0x7F)
38	26	Booth Output Level	0-127 (0x00-0x7F)
39	27	Main Output Level	0-127 (0x00-0x7F)
40	28	Session Output Level	0-127 (0x00-0x7F)
41	29	Phones Output Level	0-127 (0x00-0x7F)
42	2A	Mic Input Gain	0-127 (0x00-0x7F)
43	2B	Phones Cue/Main Pan	0-127 (0x00-0x7F)
44	2C	Mic Tone Control	0-127 (0x00-0x7F)

45	2D	Deck 4 Source	0-31 (USB A), 32-63 (PH/CD), 64-95 (AUX), 96-127 (USB B)
46	2E	Submix LP/HP Filter Type Select	0-42 (HP), 43-85 (LP), 86-127 (LP/HP)
47	2F	Deck 4 LP/HP Filter Type Select	0-42 (HP), 43-85 (LP), 86-127 (LP/HP)
48	30	Deck 4 Input Mode	0-42 (PH), 43-85 (SPDIF), 86-127 (CD)
49	31	Deck 3 Input Mode	0-42 (PH), 43-85 (SPDIF), 86-127 (CD)
50	32	Deck 3 Source	0-31 (USB A), 32-63 (PH/CD), 64-95 (AUX), 96-127 (USB B)
51	33	Deck 1 Input Mode	0-42 (PH), 43-85 (SPDIF), 86-127 (CD)
52	34	Deck 2 Input Mode	0-42 (PH), 43-85 (SPDIF), 86-127 (CD)
53	35	Deck 3 LP/HP Filter Type Select	0-42 (HP), 43-85 (LP), 86-127 (LP/HP)
54	36	Deck 2 Source	0-31 (USB A), 32-63 (PH/CD), 64-95 (AUX), 96-127 (USB B)
55	37	Deck 2 Filter Type Select	0-42 (HP), 43-85 (LP), 86-127 (LP/HP)
56	38	Deck 1 Filter Type Select	0-42 (HP), 43-85 (LP), 86-127 (LP/HP)
57	39	Deck 1 Source	0-31 (USB A), 32-63 (PH/CD), 64-95 (AUX), 96-127 (USB B)

### Control Panel MIDI Control Change Chart

Control # Dec	Control # Hex	Control Description	Data	Value
66	42	Deck 1 Phono Sensitivity	0-F	2.5 (00), 3 (01), 3.5 (02), 4 (03), 4.5 (04), 5 (05), 5.5 (06), 6 (07), 6.5 (08), 7 (09), 7.5 (0A), 8 (0B), 8.5 (0C), 9 (0D), 9.5 (0E), 10 (0F)
67	43	Deck 2 Phono Sensitivity	0-F	2.5 (00), 3 (01), 3.5 (02), 4 (03), 4.5 (04), 5 (05), 5.5 (06), 6 (07), 6.5 (08), 7 (09), 7.5 (0A), 8 (0B), 8.5 (0C), 9 (0D), 9.5 (0E), 10 (0F)
68	44	Deck 3 Phono Sensitivity	0-F	2.5 (00), 3 (01), 3.5 (02), 4 (03), 4.5 (04), 5 (05), 5.5 (06), 6 (07), 6.5 (08), 7 (09), 7.5 (0A), 8 (0B), 8.5 (0C), 9 (0D), 9.5 (0E), 10 (0F)
69	45	Deck 4 Phono Sensitivity	0-F	2.5 (00), 3 (01), 3.5 (02), 4 (03), 4.5 (04), 5 (05), 5.5 (06), 6 (07), 6.5 (08), 7 (09), 7.5 (0A), 8 (0B), 8.5 (0C), 9 (0D), 9.5 (0E), 10 (0F)
70	46	Deck 1 USB Record Source	0-7F	Record PH/CD (0-3F), Record Post (40-7F)
71	47	Deck 2 USB Record Source	0-7F	Record PH/CD (0-3F), Record Post (40-7F)
72	48	Deck 3 USB Record Source	0-7F	Record PH/CD (0-3F), Record Post (40-7F)
73	49	Deck 4 USB Record Source	0-7F	Record PH/CD (0-3F), Record Post (40-7F)
74	4A	Deck 1 Tone Crossover	0-7F	300/3.0k (0-3F), 150/6.0k (40-7F)
75	4B	Deck 2 Tone Crossover	0-7F	300/3.0k (0-3F), 150/6.0k (40-7F)
76	4C	Deck 3 Tone Crossover	0-7F	300/3.0k (0-3F), 150/6.0k (40-7F)
77	4D	Deck 4 Tone Crossover	0-7F	300/3.0k (0-3F), 150/6.0k (40-7F)
78	4E	Submix Tone Crossover	0-7F	300/3.0k (0-3F), 150/6.0k (40-7F)
79	4F	Headphone Tone	0-7F	
80	50	USB Port Active Status	Binary	Port A Active (1), Port B Active (2) [may be a combination of values]
82	52	Stereo/Mono	0-7F	Stereo (0-3F), Mono (40-7F), Checkbox
83	53	Mic Clean Feed	0-7F	Normal (0-3F), Clean Feed (40-7F), Checkbox
84	54	USB Port Local Status	0-7F	Port A Local (0-3F), Port B Local (40-7F)
86	56	Deck 1 Input Mode	0-7F	00-2A (S/PDIF), 2B-55 (Phono), 56-7F (CD)
87	57	Deck 2 Input Mode	0-7F	00-2A (S/PDIF), 2B-55 (Phono), 56-7F (CD)
88	58	Deck 3 Input Mode	0-7F	00-2A (S/PDIF), 2B-55 (Phono), 56-7F (CD)
89	59	Deck 4 Input Mode	0-7F	00-2A (S/PDIF), 2B-55 (Phono), 56-7F (CD)
90	5A	User MIDI Controls Enable Port A	0-7F	0x00 Port A User MIDI Controls Disabled, 0x01-0x7F Enabled
92	5C	User MIDI Controls Enable Port B	0-7F	0x00 Port B User MIDI Controls Disabled, 0x01-0x7F Enabled

### MIDI Note ON/OFF Chart

Note # Dec	Note # Hex	Description	Switch Type	Value
1	01	Isolator On / Off	Momentary switch	On Velocity: 0-42 = LED off, 43-127 LED On
2	02	Session Input Mode	Slider switch	On Velocity: 0-42 = LED off, 43-127 LED On
3	03	Deck 4 Submix Assign	Momentary switch	On Velocity: 0-42 = LED off, 43-127 LED On
4	04	Mic Duck	Momentary switch	On Velocity: 0-42 = LED off, 43-127 LED On
5	05	FX Assign	Toggle switch	On Velocity: 0-42 = LED off, 43-127 LED On
6	06	Session Source (USB / Analog Aux)	Toggle switch	On Velocity: 0-42 = LED off, 43-127 LED On
7	07	FX Loop On/Off	Toggle switch	On Velocity: 0-42 = LED off, 43-127 LED On
8	08	Session Input Submix Assign	Momentary switch	On Velocity: 0-42 = LED off, 43-127 LED On
9	09	Cue Split On/Off	Momentary switch	On Velocity: 0-42 = LED off, 43-127 LED On
10	0A	Microphone On/Off	Toggle switch	On Velocity: 0-42 = LED off, 43-127 LED On
11	0B	Deck 4 Cue Assign	Momentary switch	On Velocity: 0-42 = LED off, 43-127 LED On
12	0C	Deck 4 Filter On/Off	Momentary switch	On Velocity: 0-42 = LED off, 43-127 LED On
13	0D	Submix Cue Assign	Momentary switch	On Velocity: 0-42 = LED off, 43-127 LED On
14	0E	Submix Filter On/Off	Momentary switch	On Velocity: 0-42 = LED off, 43-127 LED On
15	0F	Deck 3 Submix Assign	Momentary switch	On Velocity: 0-42 = LED off, 43-127 LED On
16	10	Deck 3 Filter On	Momentary switch	On Velocity: 0-42 = LED off, 43-127 LED On
17	11	Deck 3 Cue Assign	Momentary switch	On Velocity: 0-42 = LED off, 43-127 LED On
18	12	Deck 2 Submix Assign	Momentary switch	On Velocity: 0-42 = LED off, 43-127 LED On
19	13	Deck 1 Cue Assign	Momentary switch	On Velocity: 0-42 = LED off, 43-127 LED On
20	14	Deck 2 Cue Assign	Momentary switch	On Velocity: 0-42 = LED off, 43-127 LED On
21	15	Deck 2 Filter On/Off	Momentary switch	On Velocity: 0-42 = LED off, 43-127 LED On
22	16	Deck 1 Submix Assign	Momentary switch	On Velocity: 0-42 = LED off, 43-127 LED On
23	17	Deck 1 Filter On/Off	Momentary switch	On Velocity: 0-42 = LED off, 43-127 LED On

## Technical Specifications

All specifications typical unless otherwise stated	
Four Analog Deck Inputs	Each is Phono-CD-S/PDIF switchable
....Analog Stereo RCA jacks	Phono (RIAA) or CD (line-level)
.....Phono Response	RIAA +0.1/-0.2 dB, Gain: 31 dB at 1 kHz
.....Butterworth 3rd-order Infrasonic (rumble) and 2nd-order Low-pass Filters	
.....Max Phono Input	126 mV
.....Max Line Input	4 Vrms, all unbalanced inputs
....Digital S/PDIF RCA jacks	Input 16-bit or 24-bit PCM only
.....Dynamic range of 128 dB with ultra low jitter and 16:1 SRC conversion range	
Analog Aux Input: Line Level	Stereo unbalanced RCA jacks
Session Analog Input: Line Level	Stereo unbalanced RCA jacks
Session S/PDIF Input / Output	RCA jacks (Dynamic range of 128 dB)
....Input 16-bit or 24-bit PCM only	Sample Rate 16 kHz to 144 kHz
Analog to Digital Converters	24-bit @ 44.1, 48, or 96 kHz
Digital to Analog Converters	24-bit @ 44.1, 48, or 96 kHz
Digital Signal Processing	32-bit floating point
...Dynamic Range	
.....Digital/USB Input to Line Output	116 dB A-weighted
.....Line Input to Digital/USB Output	116 dB A-weighted
.....Line Input to Line Output	113 dB A-weighted
...THD and Noise	0.0009%
USB 2.0 Audio (2 Independent Ports)	Seven stereo record, Five stereo playback
....PCM	24-bit @ 44.1, 48, or 96 kHz
....Class Compliant	No driver needed for Mac OSX
....Universal ASIO driver included for Windows 7-SP1, Windows 8 and 8.1	
FlexFX Send / Return	Stereo unbalanced RCA jacks
Mic Input	Balanced ¼" TRS & XLR combo jack
....+48V Phantom Power switch	Turn on for a condenser mic
....Mic / Line-level switch	Choose Line to connect a wireless receiver
Line Outputs	Main, Booth, Session, FlexFX Loop Send
....Frequency Response	20 Hz to 20 kHz ±0.25 dB
....Unbalanced jacks (Session & FlexFX)	Max 4 Vrms
....Balanced jacks (Main & Booth)	Max 8 Vrms
Universal Power Supply: 100 to 240 VAC	Max 20 W, 50 Hz to 60 Hz
.....Transient voltage and EMI protection, turn on muting and overload protection	
Unit: Conformity	CE, FCC, cCSAus
Size: 35.5 cm x 33.3 cm x 8.3 cm	14" H x 13.1" W x 4.3" D (includes knobs)
....Weight: 5.8 kg	12.7 lb
Shipping Size: 19.7 cm x 38.1 cm x 49 cm	7.75" H x 15" W x 19.25" D
....Weight: 7 kg	15 lb

## Mounting Ears Accessory

A mounting kit accessory is available for the Rane MP2015 Mixer, enabling it to be recess-mounted in a desk or portable coffin. These brackets / ears install easily with three screws on each side. The metal is black powder-coated electro-galvanized .075" steel. Include room for the connections on the back of the mixer, which can add up to 4" (10 cm) depending on your connectors. Leave access for the headphone jacks on the front of the mixer as well.

1. Remove the wood sides to attach the Ears.
2. Without the wood sides, the MP2015 Mixer is 12" wide (30.5 cm). The cavity needs to be 1/4" (6 mm) wider than this on each side to accommodate the mixer.
3. Attach the ears using 3 screws per side as provided in the kit. Warning: only use 6-32 x 3/8 screws. Longer screws will damage your mixer and void your warranty.
4. The Ears extend .75" (19 mm) out each side of the mixer, bringing the total width to 13.5" (34.3 cm) for mounting.

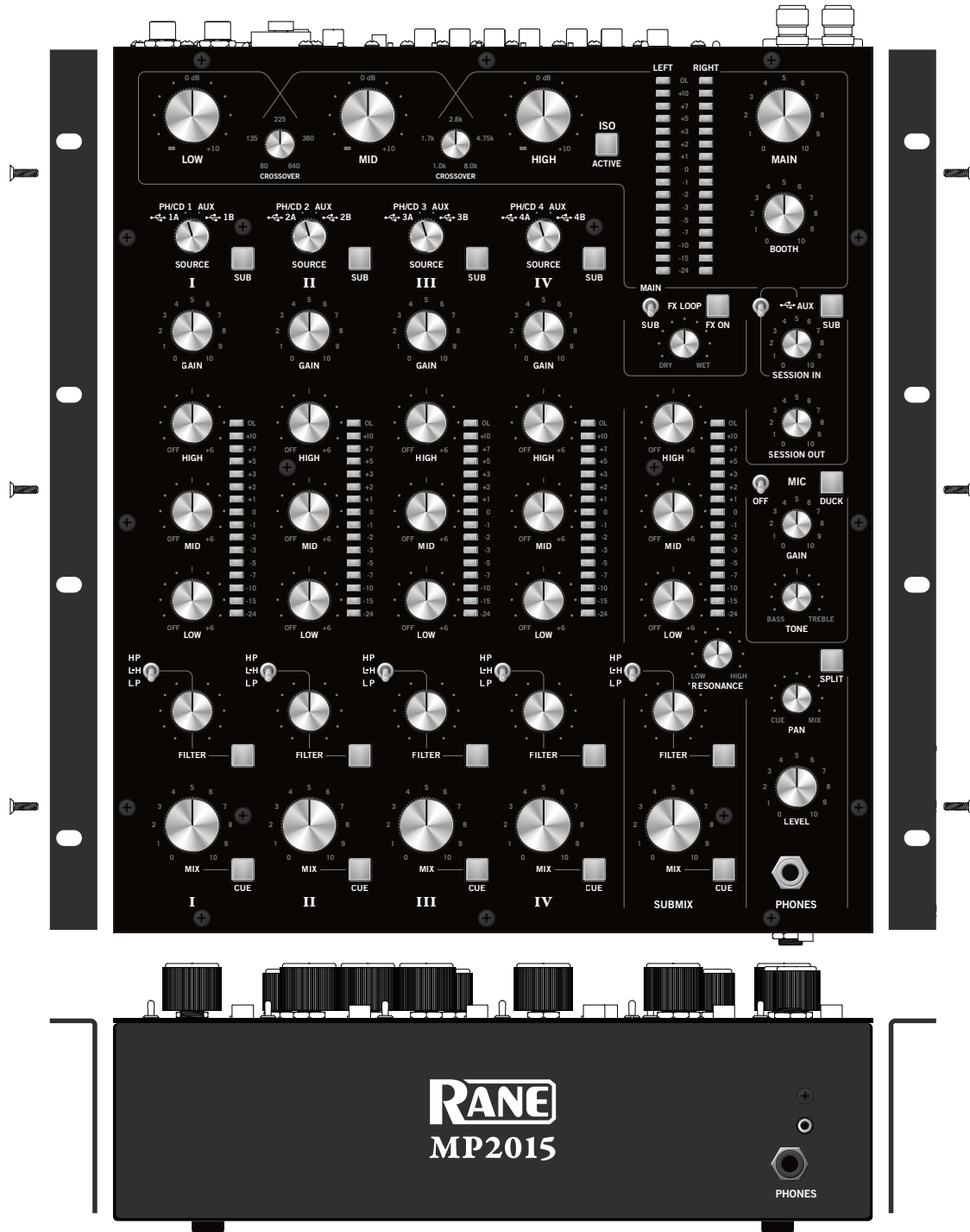

# EU Declaration of Conformity

Product Model: MP2015  
 Serial Numbers: 900000 – 999999  
 Product Type: Professional Audio Signal Processing



Manufacturer: Rane Corporation  
 Address: 10802 47th Avenue West, Mukilteo WA 98275-5000 USA

This declaration is issued under the sole responsibility of Rane Corporation.

The object of the declaration described above is in conformity with the relevant Union harmonisation legislation:

- |            |   |
|------------|---|
| 2014/35/EU | The Low Voltage Directive                               |
| 2014/30/EU | The Electromagnetic Compatibility Directive             |
| 2012/19/EU | The Waste Electrical and Electronic Equipment Directive |
| 2011/65/EU | The Restriction of Hazardous Substances Directive       |
| 2001/95/EC | The General Product Safety Directive                    |

References to the relevant harmonised standards used in relation to which conformity is declared:

- |  |   |
|--|---|
| EN60065:2002/A1:2006/A11:2008/A2:2010/A12:2011 | Safety for audio, video and similar electronic apparatus.           |
| EN55103-1:2009/AM1:2012                        | Compatibility of professional electronic A/V apparatus emissions.   |
| EN55103-2:2009                                 | Compatibility of professional electronic A/V apparatus immunity.    |
| EN50581:2012                                   | Technical documentation for RoHS assessment of electronic products. |

Additional Information:

- Environment E2
- CE mark first affixed in 2015

In order for the customer to maintain compliance with these regulations, high quality shielded cable must be used for interconnection to other equipment. No changes or modification of the equipment, other than that expressly outlined by the manufacturer, are allowed. The user of this equipment shall accept full responsibility for compliance with Union harmonisation legislation in the event that the equipment is modified without written consent of the manufacturer.

EN55103-2 Immunity Results:	THD+N: 4 dBu, 400 Hz, BW 20 Hz - 20 kHz
<i>Test Description</i>	<i>Measurement Conditions</i>
RF Electromagnetic Fields Immunity	
80 MHz - 1000 MHz, 1 kHz AM, 80% depth, 3V/m	<-68 dB
1400 MHz - 2700 MHz, 1 kHz AM, 80% depth, 3V/m	<-70 dB
Conducted RF Disturbances Immunity	
150 kHz - 80 MHz, 1 kHz AM, 80% depth, 3V rms	<-56 dB
Magnetic Fields Immunity	
50 Hz - 10 kHz, 3.0 - 0.3 A/m	<-92 dB
Common Mode Immunity (Signal Ports)	Bandpass re: 4 dBu, 1/3-octave
50 Hz - 10 kHz, -20 dBu	<-59 dB

Signed for and on behalf of: Rane Corporation  
 Place of issue: Mukilteo WA USA    Date of issue: February 3, 2015  
 Name: Greg Frederick                      Function: Compliance Engineer

Signature: 

## Limited Warranties

### Factory Authorized Service

Your unit may someday need to be serviced by the Rane Factory if you live in the USA. International customers should contact your dealer or distributor for service. You must call the Rane factory before shipping. Please do not return your unit to Rane without prior authorization.

To obtain service or a Return Authorization in the USA, please phone Rane Corporation at 425-355-6000, or fax Rane at 425-347-7757.

### Limited U.S.A. Warranty

RANE CORPORATION WARRANTS ALL RANE PRODUCTS (except those items classified and listed in "Wear Parts" on page 4) PURCHASED IN THE U.S. AGAINST DEFECTS IN MATERIAL OR WORKMANSHIP FOR A PERIOD OF TWO (2) YEARS. WEAR PARTS ARE LIMITED TO A PERIOD OF NINETY (90) DAYS FROM THE INITIAL DATE OF RETAIL PURCHASE FROM AN AUTHORIZED RANE DEALER—WEAR PARTS REQUIRE PROOF OF PURCHASE DATE. This limited warranty extends to all purchasers or owners of the product during the warranty period beginning with the original retail purchase. Rane Corporation does not, however, warrant its products against any and all defects: 1) arising out of material or workmanship not provided or furnished by Rane, or 2) resulting from abnormal use of the product or use in violation of instructions, or 3) in products repaired or serviced by other than the Rane Factory, or 4) in products with removed or defaced serial numbers, or 5) in components or parts or products expressly warranted by another manufacturer. Rane agrees to supply all parts and labor to repair or replace defects covered by this limited warranty with parts or products of original or improved design, at its option in each respect, if the defective product is shipped prior to the end of the warranty period to the Rane Factory in the original packaging or a replacement supplied by Rane, with all transportation costs and full insurance paid each way by the purchaser or owner.

### Limited Warranty Outside the U.S.A.

RANE PRODUCTS ARE WARRANTED ONLY IN THE COUNTRY WHERE PURCHASED, THROUGH THE AUTHORIZED RANE DISTRIBUTOR IN THAT COUNTRY, AGAINST DEFECTS IN MATERIAL OR WORKMANSHIP, THE SPECIFIC PERIOD OF THIS LIMITED WARRANTY SHALL BE THAT WHICH IS DESCRIBED TO THE ORIGINAL RETAIL PURCHASER BY THE AUTHORIZED RANE DEALER OR DISTRIBUTOR AT THE TIME OF PURCHASE. Rane Corporation does not, however, warrant its products against any and all defects: 1) arising out of materials or workmanship not provided or furnished by Rane, or 2) resulting from abnormal use of the product or use in violation of instructions, or 3) in products repaired or serviced by other than authorized Rane repair facilities, or 4) in products with removed or defaced serial numbers, or 5) in components or parts or products expressly warranted by another manufacturer. Rane agrees, through the applicable authorized distributor, to repair or replace defects covered by this limited warranty with parts or products of original or improved design, at its option in each respect, if the defective product is shipped prior to the end of the warranty period to the designated authorized Rane warranty repair facility in the country where purchased, or to the Rane factory in the U.S., in the original packaging or a replacement supplied by Rane, with all transportation costs and full insurance paid each way by the purchaser or owner.

ALL REMEDIES AND THE MEASURE OF DAMAGES ARE LIMITED TO THE ABOVE SERVICES, IT IS POSSIBLE THAT ECONOMIC LOSS OR INJURY TO PERSON OR PROPERTY MAY RESULT FROM THE FAILURE OF THE PRODUCT; HOWEVER, EVEN IF RANE HAS BEEN ADVISED OF THIS POSSIBILITY, THIS LIMITED WARRANTY DOES NOT COVER ANY SUCH CONSEQUENTIAL OR INCIDENTAL DAMAGES. SOME STATES OR COUNTRIES DO NOT ALLOW THE LIMITATIONS OR EXCLUSION OF INCIDENTAL OR CONSEQUENTIAL DAMAGES, SO THE ABOVE LIMITATION MAY NOT APPLY TO YOU.

ANY AND ALL WARRANTIES, EXPRESS OR IMPLIED, ARISING BY LAW, COURSE OF DEALING, COURSE OF PERFORMANCE, USAGE OF TRADE, OR OTHERWISE, INCLUDING BUT NOT LIMITED TO IMPLIED WARRANTIES OF MERCHANTABILITY AND FITNESS FOR A PARTICULAR PURPOSE, ARE LIMITED TO A PERIOD OF TWO (2) YEARS FROM EITHER THE DATE OF ORIGINAL RETAIL PURCHASE OR, IN THE EVENT NO PROOF OF PURCHASE DATE IS AVAILABLE, THE DATE OF MANUFACTURE, SOME STATES OR COUNTRIES DO NOT ALLOW LIMITATIONS ON HOW LONG AN IMPLIED WARRANTY LASTS, SO THE ABOVE LIMITATIONS MAY NOT APPLY TO YOU. THIS LIMITED WARRANTY GIVES YOU SPECIFIC LEGAL RIGHTS, AND YOU MAY ALSO HAVE OTHER RIGHTS WHICH VARY FROM STATE TO STATE, COUNTRY TO COUNTRY.

## Warranty Procedure - Valid in U.S.A. only

**NOTICE! You must complete and return the warranty card or register your product online to extend the Warranty from 2 years to 3 years!**

TO VALIDATE YOUR EXTENDED WARRANTY: Use the postcard that came in the box with your unit, or go to the **support** page at [dj.rane.com](http://dj.rane.com) and click on **product registration**. Fill out the warranty completely, being sure to include the model and serial number of the unit since this is how warranties are tracked. If your Rane product was purchased in the U.S.A., mail the completed card or register online with to Rane Corporation within 10 days from the date of purchase. **If you purchased the product outside the U.S.A. you must file your warranty registration with the Rane Distributor in that country.** It is advised that you keep your bill of sale as proof of purchase, should any difficulties arise concerning the registration of the warranty card. **NOTICE: IT IS NOT NECESSARY TO REGISTER IN ORDER TO RECEIVE RANE CORPORATION'S STANDARD TWO YEAR LIMITED WARRANTY.**

WARRANTY REGISTRATION is made and tracked by MODEL AND SERIAL NUMBERS ONLY, not by the purchaser's or owner's name. Therefore any warranty correspondence or inquires MUST include the model and serial number of the product in question. Be sure to fill in the model and serial number in the space provided below and keep this in a safe place for future reference.

WARRANTY SERVICE MUST BE PERFORMED ONLY BY AN AUTHORIZED RANE SERVICE FACILITY LOCATED IN THE COUNTRY WHERE THE UNIT WAS PURCHASED, OR (if product was purchased in the U.S.) AT THE RANE FACTORY IN THE U.S.. If the product is being sent to Rane for repair, please call the factory for a Return Authorization number. We recommend advance notice be given to the repair facility to avoid possible needless shipment in case the problem can be solved over the phone. UNAUTHORIZED SERVICE PERFORMED ON ANY RANE PRODUCT WILL VOID ITS EXISTING FACTORY WARRANTY.

FACTORY SERVICE: If you wish your Rane product to be serviced at the factory, it must be shipped FULLY INSURED, IN THE ORIGINAL PACKING OR EQUIVALENT. This warranty will NOT cover repairs on products damaged through improper packaging. If possible, avoid sending products through the mail. Be sure to include in the package:

1. Complete return street shipping address (P.O. Box numbers are NOT acceptable).
2. A detailed description of any problems experienced, including the make and model numbers of any other system equipment.
3. Remote power supply, if applicable.

Repaired products purchased in the U.S. will be returned prepaid freight via the same method they were sent to Rane. Products purchased in the U.S., but sent to the factory from outside the U.S. MUST include return freight funds, and the sender is fully responsible for all customs procedures, duties, tariffs and deposits.

**In order to qualify for Rane's one year extended warranty (for a total of 3 years parts and labor), the warranty must be completely filled out and sent to us immediately. Valid in USA only.**

**We recommend you write your serial number here in your owners manual and on your sales receipt for your records.**

SERIAL NUMBER: \_\_\_\_\_ PURCHASE DATE: \_\_\_\_\_

**[dj.rane.com](http://dj.rane.com) is your center for support, accessories, community, and learning how to get the most from your MP2015 Mixer.**



**Rhox Áudio e Vídeo Profissional** - SIBS Quadra 2 conjunto C Lote 12  
Brasília - DF - 71736.203 - Tel (61) 3051-5800  
<https://loja.rhox.com.br>

