

# DENON

***PROFESSIONAL***

## DN-300Z

User Guide	English ( 3 – 20 )
Guía del usuario	Español ( 21 – 38 )
Guide d'utilisation	Français ( 39 – 56 )
Guida per l'uso	Italiano ( 57 – 74 )
Benutzerhandbuch	Deutsch ( 75 – 92 )
Appendix	English ( 93 – 95 )



## User Guide (English)

### Introduction

#### Box Contents

DN-300Z	Bluetooth™ Antenna
Power Cable	Remote Control
FM Indoor Antenna	User Guide
AM Loop Antenna	Safety and Warranty Manual

#### Support

For the latest information about this product (system requirements, compatibility information, etc.) and product registration, visit [denonpro.com](http://denonpro.com).

### Safety Instructions

Please also see the included *Safety and Warranty Manual* for more information.

**Before turning the power on:** Make sure all connections are secure and correct and that there are no problems with the connection cables.

Power is supplied to some of the circuitry even when the unit is powered off. When the unit will not be used for long periods of time, disconnect the power cable from the power outlet.

**Proper ventilation:** If the unit is left in a room which is not properly ventilated or is full of smoke from cigarettes, dust, etc. for long periods of time, the surface of the optical pickup may get dirty, causing incorrect operation.

**About condensation:** If there is a major difference in temperature between the inside of the unit and the surroundings, condensation may form inside the unit, causing the unit not to operate properly. If this happens, let the unit sit for an hour or two while powered off, and wait until there is little difference in temperature before using the unit.

**Cautions on using mobile phones:** Using a mobile phone near this unit may cause noise. If this occurs, move the mobile phone away from this unit when it is in use.

**Moving the unit:** Before moving the unit, turn off its power and disconnect the power cable from the power outlet. Next, disconnect its connection cables from other devices before moving it.

**About care:** Wipe the cabinet and control panel clean with a soft cloth.  
Follow the instructions when using a chemical cleaner.  
Do not use benzene, paint thinner, insecticide, or other organic solvents to clean the unit. These materials can cause material changes and discoloration.

**Rackmount warnings:** EIA standard 19-inch (48.3cm) rack  
(required rack specifications for mounting the unit in a rack) 1U-size installation compatible rack  
Rack that has a guide rail or shelf board that can support this device

**Rack installation:** This product will work normally when the player unit is mounted within 10° off the vertical plane at the front panel. If the unit is tilted excessively, the disc may not load or unload properly. (See image.)

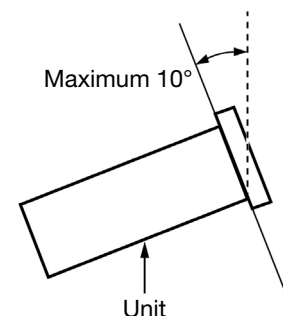

## Features

### Front Panel

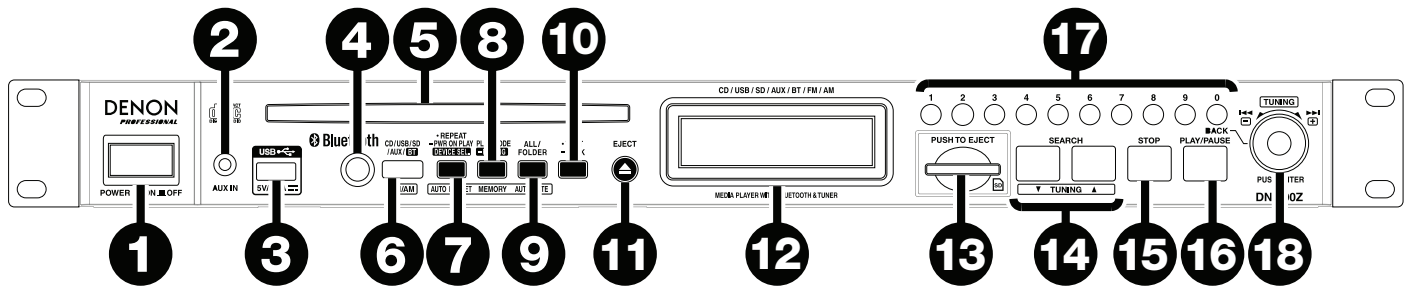





- Power Button:** Press this button to turn the unit on or off. Make sure the **AC In** is properly connected to a power outlet. Do not turn the unit off during media playback—doing so could damage your media.
- Aux In:** Connect an optional device to this input using a 1/8" (3.5mm) TRS cable. See [Operation > Playing Audio from an External Device](#) for more information.
- USB Port:** Connect a mass-storage-class USB device to this port. See [Operation > Playing Audio Files](#) for more information.
- Remote Sensor:** Point the remote control at this sensor when operating it. See [Remote Control > Operating Range](#) for more information.
- CD Slot:** Insert a CD into this slot. See [Operation > Playing Audio CDs](#) or [Playing Audio Files](#) for more information.
- Media Button:** Press this to enter Media Selection screen. See [Operation > Selecting Media Playback Mode](#) for more information.
- Repeat Button:** In CD, USB, or SD Mode, press this button to switch between Repeat Playback modes: **Repeat One**, **Repeat All**, and **Repeat Off**. See [Operation > Playing Audio CDs](#) or [Playing Audio Files](#) for more information.  
**Auto Preset Button:** In FM/AM Mode, press this button to automatically scan available radio stations and register them to the preset memory. See [Operation > Using the Radio](#) for more information.  
**Device Select Button:** In Bluetooth Mode, press this button to select a Bluetooth device from a list of devices that have been previously paired to the unit. See [Operation > Playing Audio from a Bluetooth Device](#) for more information.  
**Power-On Play Button:** Press and hold this button to turn Power-On Play on or off. See [Operation > Additional Functions > Power-On Play](#) for more information.
- Play Mode Button:** In CD Mode, press this button to cycle through Normal Play Mode, Single Play Mode, and Random Play Mode. In USB or SD Mode, press this button to turn Random Play Mode on or off. See [Operation > Playing Audio CDs](#) or [Playing Audio Files](#) for more information.  
**Memory Button:** In FM/AM Mode, press this button to enter Preset Memory Registration Mode. After that, press a number button (0–9) to register the current station to that preset memory number. Press and hold this button to erase the station stored to the current preset memory number. See [Operation > Using the Radio](#) for more information.  
**Pairing Button:** In Bluetooth Mode, press and hold this button to let the unit pair to a nearby Bluetooth device. See [Operation > Playing Audio from a Bluetooth Device](#) for more information.
- All/Folder Button:** In CD, USB, or SD Mode, press this button to switch between Folder View and All View. See [Operation > Playing Audio Files](#) for more information.  
**Auto Mute Button:** In FM/AM Mode, press this button to turn Auto Mute on or off. See [Operation > Using the Radio](#) for more information.
- Text Button:** In CD, USB or SD Mode, press this button to switch the display between the file name and other text information. See [Operation > Playing Audio Files](#) for more information.  
**Lock Button:** Press and hold this button to turn Panel Lock on and off. See [Operation > Additional Functions > Panel Lock](#) for more information.

11. **Eject Button:** Press this to eject the CD in the CD slot.
12. **Display:** This screen indicates the unit's current operation. See [Display](#) for more information.
13. **SD Card Slot:** Insert an SD/SDHC card into this slot. See [Operation > Playing Audio Files](#) for more information.
14. **Search Buttons:** In CD, USB, or SD Mode, press and hold one of these buttons to rewind/fast-forward. Initially, the track will rewind/fast-forward at **5** times the normal playback speed. After holding the button for more than 1 second, the track will rewind/fast-forward at **30** times the normal playback speed.  
  
In Bluetooth Mode with a device compatible with AVRCP, press and hold one of these buttons to rewind/fast-forward.  
  
**Tuning Buttons:** In FM/AM Mode, press one of these buttons to increase or decrease the frequency one step at a time. Press and hold the button for more than 1 second to jump to the previous or next station with clear reception.
15. **Stop Button:** Press this button to stop playback.
16. **Play/Pause Button:** Press this button to start, resume, or pause playback.
17. **Number Buttons (0–9):** In CD Mode, Press one of these buttons to directly select a track to play. If the track number is two digits, press the buttons in succession (e.g., **1** then **2** for Track 12). See [Operation > Playing Audio CDs](#) for more information.  
  
In FM/AM Mode, press one of these buttons to directly select a station stored to preset number. If the preset number is two digits, press the buttons in succession (e.g., **1** then **2** for Preset 12). See [Operation > Using the Radio](#) for more information.  
  
**Back Button:** When in CD, USB, or SD Mode and in Folder View, press the last **0** Number Button (labeled **Back**) to move up one folder level. See [Operation > Playing Audio Files](#) for more information.
18. **Jog Dial:** Turn this dial to browse the options shown in the display (e.g., media types in the Media Selection screen, files/folders in CD, USB, or SD Mode, etc.). Press this dial to confirm a selection.  
  
In Bluetooth Mode with a device compatible with AVRCP, turn this dial to select tracks.





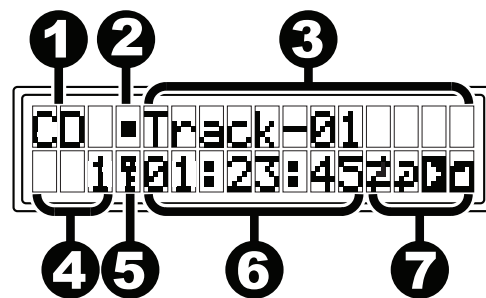

## Display

1. **Media Type:** This is the currently selected media: **CD, USB, SD, AUX, BT, FM, or AM**. See [Operation > Selecting Media Playback Mode](#) for more information.
2. **Playback Operation Icon:** This shows various symbols to indicate the current playback status:
 

 Playing	 Rewinding
 Paused	 Fast-Forwarding
 Stopped	
3. **Information:** This shows extra information about the media being played or the current station.
4. **Track/File Number:** This is the number of the track or file.  
  
**Preset Number:** In FM/AM Mode, if the current station is registered to the preset memory, this is the preset number. See [Operation > Using the Radio](#) for more information.
5. **Panel Lock:** When Panel Lock is on, a key symbol appears here. See [Operation > Additional Functions > Panel Lock](#) for more information.
6. **Time:** In CD, USB, and SD Mode, this is how much time has elapsed or is remaining, shown as **hh:mm:ss** (hours, minutes, and seconds). See [Operation > Playing Audio CDs](#) or [Playing Audio Files](#) for more information.  
  
**Frequency:** In FM/AM Mode, this displays the frequency of the current station. See [Operation > Using the Radio](#) for more information.



7. **Function Icons:** This shows various symbols to indicate these current functions:

-  Random Playback (see [Operation > Playing Audio CDs](#) or [Playing Audio Files](#) for more information)
-  Repeat One (see [Operation > Playing Audio CDs](#) or [Playing Audio Files](#) for more information)
-  Repeat All (see [Operation > Playing Audio CDs](#) or [Playing Audio Files](#) for more information)
-  All View (see [Operation > Playing Audio Files](#) for more information)
-  Folder View (see [Operation > Playing Audio Files](#) for more information)
-  Auto Mute (see [Operation > Using the Radio](#) for more information)
-  Power-On Play (see [Operation > Additional Functions > Power-On Play](#) for more information)

## Rear Panel

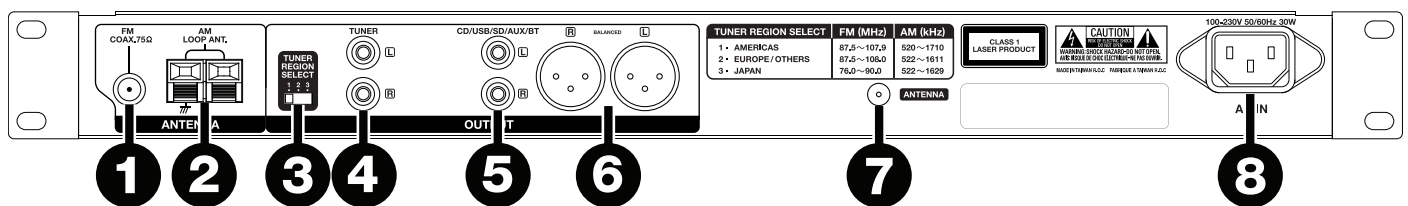

1. **FM Antenna Terminal:** Connect the included FM antenna to this terminal.
2. **AM Antenna Terminals:** Connect the included AM loop antenna to this terminal. See [Setup / Connection Diagram](#) for more information.
3. **Tuner Region Select Switch:** Set this switch according to the area where you live: **1** (North and South America), **2** (Europe and Asia Pacific region), or **3** (Japan).
 

**Note:** If the unit is powered on, turn its power off and on again after changing this setting. When the unit powers on again, it will be set for the selected area.
4. **Tuner Outputs (unbalanced):** These outputs send the FM/AM audio signal. Use RCA cables to connect these outputs to external speakers, sound system, etc. See [Setup / Connection Diagram](#) for more information.
5. **CD/USB/SD/AUX/BT Outputs (unbalanced RCA):** These outputs send the audio signals from a CD, USB device (mass storage class), SD card, device connected to the Aux In, and connected Bluetooth device. Use RCA cables to connect these outputs to external speakers, sound system, etc. See [Setup / Connection Diagram](#) for more information.
6. **CD/USB/SD/AUX/BT Outputs (balanced XLR):** These outputs send the audio signals from a CD, USB device (mass storage class), SD card, device connected to the Aux In, and connected Bluetooth device. Use XLR cables to connect these outputs to external speakers, sound system, etc. See [Setup / Connection Diagram](#) for more information.
7. **Bluetooth Antenna Terminal:** Connect the included Bluetooth antenna to this terminal. The antenna receives and transmits the Bluetooth signal from and to your Bluetooth device, if it is within range.
8. **AC In:** Use the included power cable to connect this input to a power outlet. See [Setup / Connection Diagram](#) for more information.

## Remote Control

1. **CD/USB/SD/AUX/BT:** Press this button to cycle through CD, USB, SD, Aux, or Bluetooth modes. See [Operation > Selecting Media Playback Mode](#) for more information.
2. **FM/AM:** Press this button to switch between FM and AM modes. See [Operation > Selecting Media Playback Mode](#) for more information.
3. **Time Button:** In CD, USB, or SD Mode, press this button to switch the Time Mode in the **display**. See [Operation > Playing Audio CDs](#) or [Playing Audio Files](#) for more information.
4. **Eject Button:** Press this to eject the CD in the **CD Slot**.
5. **Skip Buttons:** In CD, USB, or SD Mode, press one of these buttons to move to the previous or next track. See [Operation > Playing Audio CDs](#) or [Playing Audio Files](#) for more information.

In FM/AM Mode, press one of these buttons to select the previous or next station stored to preset number. See [Operation > Using the Radio](#) for more information.

In Bluetooth Mode with a device compatible with AVRCP, press one of these buttons to select the previous or next track.

6. **Play/Pause Button:** Press this button to start, resume, or pause playback.
7. **All/Folder Button:** In CD, USB, or SD Mode, press this button to switch between Folder View and All View. See [Operation > Playing Audio Files](#) for more information.
8. **Search Buttons:** In CD, USB, or SD Mode, press and hold one of these buttons to rewind/fast-forward. Initially, the track will rewind/fast-forward at **5** times the normal playback speed. After holding the button for more than 1 second, the track will rewind/fast-forward at **30** times the normal playback speed.

In Bluetooth Mode with a device compatible with AVRCP, press and hold one of these buttons to rewind/fast-forward.

**Tuning Buttons:** In FM/AM Mode, press one of these buttons to increase or decrease the frequency one step at a time. Press and hold the button for more than 1 second to jump to the previous or next station with clear reception.

9. **Stop Button:** Press this button to stop playback.
10. **Auto Preset Button:** In FM/AM Mode, press this button to automatically scan available radio stations and register them to the preset memory. See [Operation > Using the Radio](#) for more information.
11. **Number Buttons (0–9):** In CD Mode, Press one of these buttons to directly select a track to play. If the track number is two digits, press the buttons in succession (e.g., **1** then **2** for Track 12). See [Operation > Playing Audio CDs](#) for more information.

In FM/AM Mode, press one of these buttons to directly select a station stored to preset number. If the preset number is two digits, press the buttons in succession (e.g., **1** then **2** for Preset 12). See [Operation > Using the Radio](#) for more information.

**Cursor Buttons:** When in CD, USB, or SD Mode, use these buttons to navigate through the files and folders. See [Operation > Playing Audio Files](#) for more information.

12. **Memory Button:** In FM/AM Mode, press this button to enter Preset Memory Registration Mode. After that, press a number button (**0–9**) to register the current station to that preset memory number. Press and hold this button to erase the station stored to the current preset memory number. See [Operation > Using the Radio](#) for more information.
13. **Auto Mute Button:** In FM/AM Mode, press this button to turn Auto Mute on or off. See [Operation > Using the Radio](#) for more information.
14. **Text Button:** In CD, USB or SD Mode, press this button to switch the display between the file name and other text information. See [Operation > Playing Audio Files](#) for more information.

**Lock Button:** Press and hold this button to turn Panel Lock on and off. See [Operation > Additional Functions > Panel Lock](#) for more information.

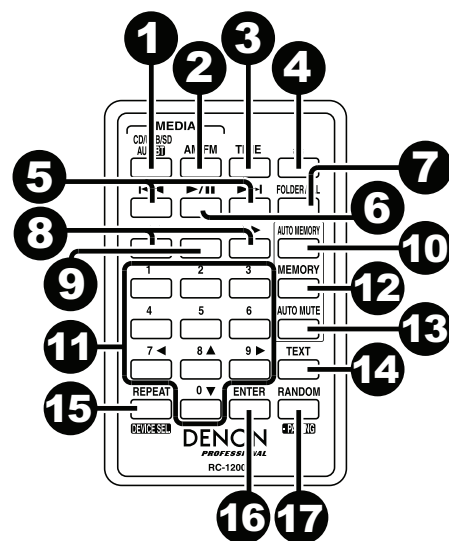

15. **Repeat Button:** In CD, USB, or SD Mode, press this button to switch between Repeat Playback modes: **Repeat One**, **Repeat All**, and **Repeat Off**. See [Operation > Playing Audio CDs](#) or [Playing Audio Files](#) for more information.

**Power-On Play Button:** Press and hold this button to turn Power-On Play on or off. See [Operation > Additional Functions > Power-On Play](#) for more information.

16. **Enter Button:** Press this button to confirm a selection.

17. **Play Mode Button:** In CD Mode, press this button to cycle through Normal Play Mode, Single Play Mode, and Random Play Mode. In USB or SD Mode, press this button to turn Random Play Mode on or off. See [Operation > Playing Audio CDs](#) or [Playing Audio Files](#) for more information.

**Pairing Button:** In Bluetooth Mode, press and hold this button to let the unit pair to a nearby Bluetooth device. See [Operation > Playing Audio from a Bluetooth Device](#) for more information.

## Battery Usage

**Important:** Before using the remote control for the first time, pull the insulation sheet out from the battery compartment (see image).

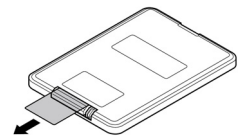

**To replace the battery** (see image):

1. On the back of the remote control, push the small tab toward the larger one, and pull out the battery case.
2. Pull out the old lithium battery from the battery case and insert a new one. Place the battery so that the positive (+) side faces upward.
3. Replace the battery case in its original position.

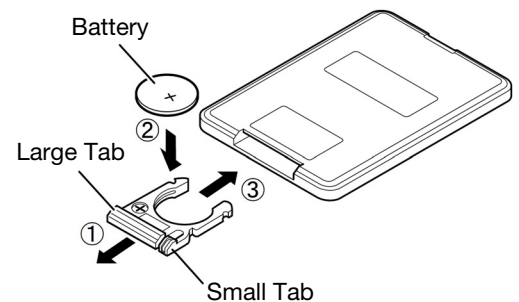

**Important:** Misuse of the lithium battery can result in heat build-up, ignition, or rupture. Bear in mind the following points when using or replacing batteries:

- The supplied battery is for testing the functionality of the remote controller.
- Use a **CR2025** lithium battery.
- Never recharge the battery. Do not handle the battery roughly or disassemble the battery.
- When replacing the battery, place it with its polarities (+ and -) facing the correct directions.
- Do not leave the battery in a place subject to high temperature or direct sunlight.
- Keep the battery in a place beyond the reach of infants or children. If a battery is swallowed, consult a physician **immediately**.
- If electrolyte has leaked, discard the battery immediately. Be careful when handling it as the electrolyte can burn your skin or clothes. If the electrolyte touches your skin or clothes, immediately wash with tap water and consult a physician.
- Before discarding a battery, insulate it with tape, etc. and dispose of it in a place without fire, by following the directions or regulations laid down by the local authorities in the area of its disposal.

## Operating Range

Point the remote control unit at the remote sensor when operating it.

**Note:** If the remote control sensor is exposed to direct sunlight, strong artificial light (like from an inverter-type fluorescent lamp), or infrared light, the unit or remote control may not function properly.

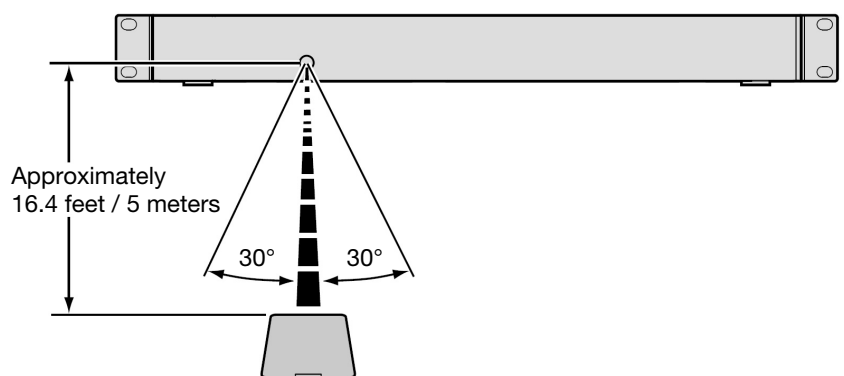

## Setup / Connection Diagram

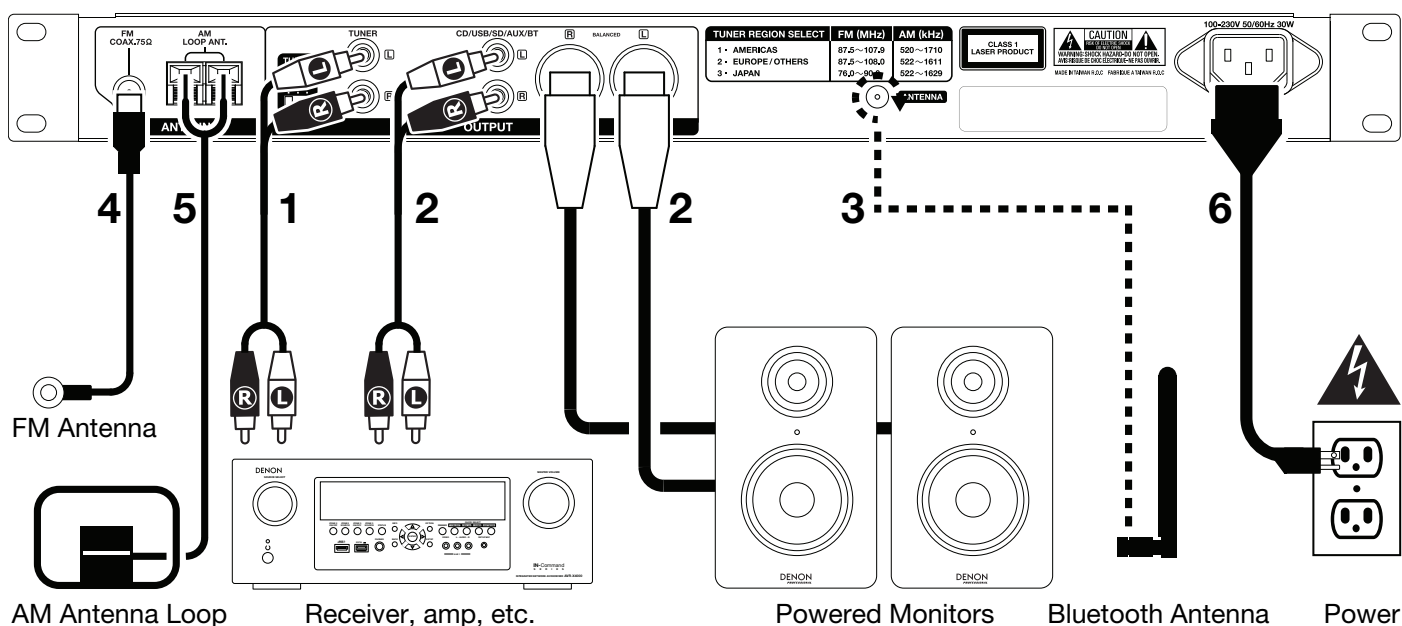

Items not listed under the **Box Contents** are sold separately.

**Important:** Connect all cables securely and properly (with stereo cables: left with left, right with right), and do not bundle them with the power cable.

1. Use a stereo RCA cable to connect the **Tuner Outputs** (unbalanced) to the analog inputs of your external receiver, amp, etc. Make sure the **Tuner Region Select Switch** is set to the number for your location: **1** (North and South America, **2** (Europe and Asia Pacific region), or **3** (Japan).

**Note:** If the unit's power is on, turn the power off and on again. If the unit is powered on, turn its power off and on again after changing this setting. When the unit powers on again, it will be set for the selected area.

2. Use XLR cables or a stereo RCA cable to connect the **CD/USB/SD/AUX/BT Outputs** (balanced or unbalanced) to the analog inputs of your external receiver, amp, powered monitors, etc.
3. Connect the included Bluetooth antenna to the **Bluetooth Antenna Terminal**.
4. Connect the included FM antenna to the **FM Antenna Terminal**.
5. Connect the included AM antenna loop to the **AM Antenna Terminals**. Make sure the AM loop antenna lead terminals do not touch metal parts of the panel. (Even if you use an external AM antenna, do not disconnect the AM loop antenna.)

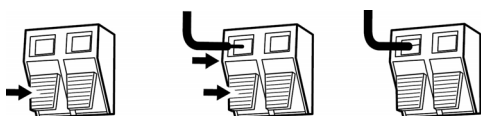

If you want to hang the AM antenna loop on a wall, use a nail or tack to attach it (unassembled) to the wall.

If you want to stand the AM antenna loop on a flat surface, assemble it (see images below):

- i. Put the stand section through the bottom of the loop antenna from the rear and bend it forward.
- ii. Insert the projecting part into the square hole in the stand.

6. After completing all the connections, use the included power cable to connect the **AC In** to a power outlet.

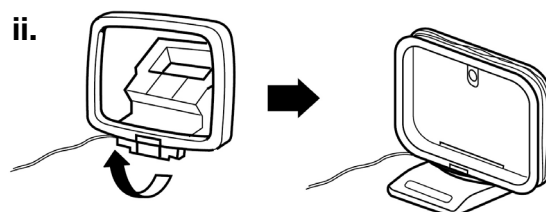
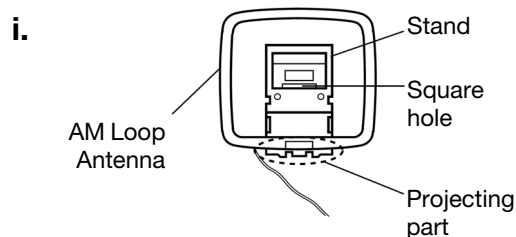

## Operation

### Selecting the Media Playback Mode

To select what kind of media you want to play:

1. When the unit is stopped or paused, press the **Media Button**.
2. To cycle through the available options, turn the **Jog Dial** or press the **Media Button** on the unit. If you are using the remote control, press the **CD/USB/SD/Aux** or **FM/AM** buttons.
  - **CD** or **CDR**: audio CD (**CD**) or CD with audio files (**CDR**) (see [Playing Audio CDs](#) and [Playing Audio Files](#))
  - **USB**: USB device (mass storage class) (see [Playing Audio Files](#))
  - **SD**: SD or SDHC card (see [Playing Audio Files](#))
  - **AUX**: device connected to **Aux In** (see [Playing Audio from an External Device](#))
  - **BT**: Bluetooth device (see [Playing Audio from a Bluetooth Device](#))
  - **FM**: FM radio broadcast (see [Using the Radio](#))
  - **AM**: AM radio broadcast (see [Using the Radio](#))
3. To confirm your choice, press the **Jog Dial** on the unit, or press the **Enter Button** on the remote control.

**Important:** The DN-300Z will remember this setting even if you power off the unit.

### Playing Audio CDs

To play audio CDs:

1. If the unit is off, press the **Power Button** to power it on.

**Important:** Do not insert a CD when the power is off. Doing so may damage the unit.
2. Insert a CD into the **CD Slot**. (Hold the edges of the CD without touching the recorded surface. Be careful not to trap your fingers when the disc is drawn into the unit.)

**Important:** This unit can play finalized discs only. (Finalization is the process that makes recorded CD-R discs playable on compatible players.)
3. Select **CD** as the media type (described in [Selecting the Media Playback Mode](#)).
4. To start playback, press the **Play** button on the unit or remote control.

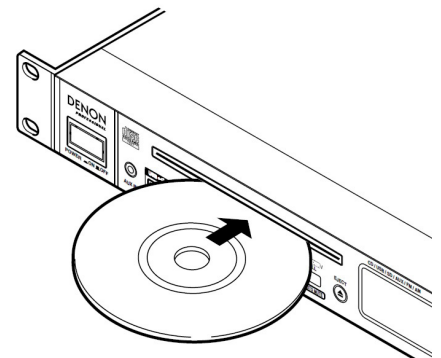

In CD Mode, you can perform any of the following operations:

- **To start, resume, or pause playback**, press the **Play/Pause Button** on the unit or remote control.
- **To stop playback**, press the **Stop Button** on the unit or remote control.
- **To rewind or fast-forward through the track**, press and hold one of the **Search Buttons** on the unit or remote control. Initially, the track will rewind/fast-forward at **5** times the normal playback speed. After holding the button for more than 1 second, the track will rewind/fast-forward at **30** times the normal playback speed. To resume playback, release the button.
- **To return to the start of the current track**, turn the **Jog Dial** counterclockwise one notch on the unit, or press the “back” **Skip Button** once on the remote control.
- **To skip to the previous or next track**, press one of the **Skip Buttons** on the remote control.

- **To skip directly to a track:**
  1. Press one of the **Number Buttons (0–9)** on the unit or remote control to enter the desired track number. If the track number is two digits, press the buttons in succession (e.g., **1** then **2** for Track 12).
  2. Press the **Jog Dial** on the unit, or press the **Enter Button** on the remote control. (The new track will load automatically if you do not do this within 1 second.)
- **To select a Repeat Playback mode**, press the **Repeat Button**. It will cycle through **Repeat One** (the same track will repeat indefinitely), **Repeat All** (the list of all tracks will repeat indefinitely), and **Repeat Off** (no tracks will repeat).
- **To select the Play Mode**, press the **Play Mode Button**. It will cycle through **Normal** (the CD will play from the current track to the end of the CD and then stop), **Single** (the current track will play until its end and then stop), and **Random** (the tracks will play in a random order [for up to **256** tracks]).
- **To change the Time Mode in the display**, press the **Time Button** on the remote control. It will cycle through **Elapsed** (how much time has elapsed of the current track), **Remain** (how much time remains of the current track), and **T.Remain** (how much time remains of all remaining tracks).
- **To eject a CD**, press the **Eject Button**. **Ejecting** will appear in the **display** while ejecting the CD. **No Disc** will appear when there is no disc in the **CD Slot**.

For information about playing CDs with audio files, please see [Operation > Playing Audio Files](#).

**Important:** Please see [Other Information > CDs](#) to learn more about the types of CDs the DN-300Z supports and for more information about CD handling and care.

## Playing Audio Files

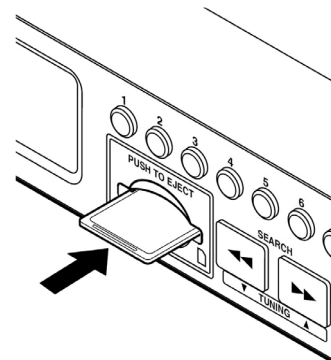
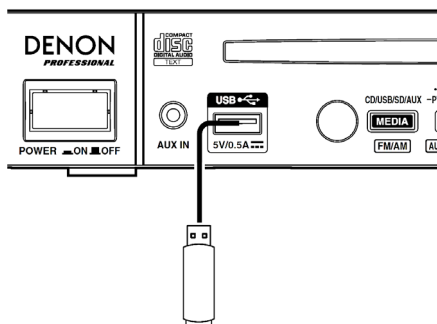
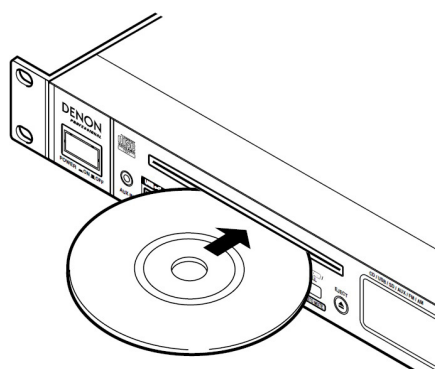

### To play audio files on a CD, USB device, or SD card:

1. If the unit is off, press the **Power Button** to power it on.

**Important:** Do not insert a CD when the power is off. Doing so may damage the unit.

2. Do one of the following:

- Insert a CD into the **CD Slot**. (Hold the edges of the CD without touching the recorded surface. Be careful not to trap your fingers when the disc is drawn into the unit.)

**Important:** This unit can play finalized discs only. (Finalization is the process that makes recorded CD-R discs playable on compatible players.)

- Connect your USB device (mass storage class) to the **USB Port**.
- Insert your SD card into the **SD Card Slot** until you hear it “click.”

**Note:** You can play **MP3** files on a CD-R or CD-ROM, or you can play **AAC**, **MP3**, and **WAV** files on a USB device or SD card.

3. Select your desired media type: **CD**, **USB**, or **SD** (described in [Selecting the Media Playback Mode](#)).
4. Press the **All/Folder Button** to change the view mode (if desired). In Folder View, a paper symbol will appear in the **display**. In All View, a music note symbol will appear in the **display**.



5. Select an audio file:

- In Folder View, all audio files in a selected folder will play.
  - **To move through a list of folders or audio files**, turn the **Jog Dial** on the unit, or press the “up” or “down” **Cursor Buttons** on the remote control.
  - **To enter a folder**, press the **Jog Dial** on the unit, or press the “right” **Cursor Button** or **Enter Button** on the remote control.
  - **To exit a folder**, press the **0 (Back) Button** on the unit, or press the “left” **Cursor Button** on the remote control.
- In All View, all audio files on the CD, USB device, or SD card will play. The files will appear in the **display** as if they were on the root directory level.
  - **To move through the list of audio files**, turn the **Jog Dial**, or press the “up” or “down” **Cursor Buttons** on the remote control.

6. To load the desired audio file, press the **Jog Dial** on the unit, or press the **Enter Button** on the remote control.

7. To start playback, press the **Play Button** on the unit or remote control. Alternatively, press the **Jog Dial** on the unit, or press the **Enter Button** on the remote control.

In CD, USB, or SD Mode, you can perform any of the following operations:

- **To start, resume, or pause playback**, press the **Play/Pause Button** on the unit or remote control.
- **To stop playback**, press the **Stop Button** on the unit or remote control.
- **To rewind or fast-forward through the track**, press and hold one of the **Search Buttons** on the unit or remote control. Initially, the track will rewind/fast-forward at **5** times the normal playback speed. After holding the button for more than 1 second, the track will rewind/fast-forward at **30** times the normal playback speed. To resume playback, release the button.
- **To return to the start of the current track**, turn the **Jog Dial** counterclockwise one notch on the unit, or press the “back” **Skip Button** once on the remote control.
- **To skip to the previous or next track**, press one of the **Skip Buttons** on the remote control.
- **To change the view mode**, press the **All/Folder Button**.
- **To select another folder or audio file**, follow the steps described in [Step 5](#) above.
- **To show different track information in the display**, press the **Text** button. It will cycle through the file name, title name, artist name, album name, and folder name.
- **To select a Repeat Playback mode**, press the **Repeat Button**. It will cycle through **Repeat One** (the same track will repeat indefinitely), **Repeat All** (the list of all tracks will repeat indefinitely), and **Repeat Off** (no tracks will repeat).
- **To turn Random Playback on or off**, press the **Play Mode Button**. When on, the tracks will play in a random order. You can use Random Playback for up to **256** tracks.
- **To change the Time Mode in the display**, press the **Time Button** on the remote control. It will cycle through **Elapsed** (how much time has elapsed of the current track) and **Remain** (how much time remains of the current track).
- **To eject a CD**, press the **Eject Button**. **Ejecting** will appear in the **display** while ejecting the CD. **No Disc** will appear when there is no disc in the **CD Slot**.
- **To remove a USB device**, gently remove it from the **USB Port** when it is **not playing**. (Removing a USB device while it is playing can damage it.)
- **To remove an SD card**, gently press it into the **SD Card Slot** when it is **not playing**. The SD card will spring out after which, you can remove it (see image). (Removing an SD card while it is playing can damage it.)

**Important:**

Please see [Other Information](#) to learn more about the types of CDs, USB devices, and SD cards the DN-300Z supports.

Inserting a CD will cause the unit to enter CD Mode automatically.

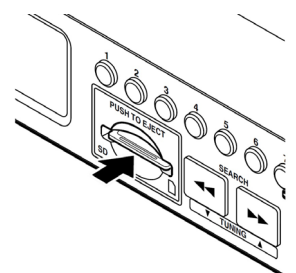

## Playing Audio from a Bluetooth Device

You can play audio from an audio device that sends its signal over a Bluetooth connection (e.g., smartphones, tablet computers, etc.).

- **If this is the first time you are using a Bluetooth device with your DN-300Z**, please see [Pairing a Bluetooth Device](#). This will tell you how to **pair** your Bluetooth device with your DN-300Z (your Bluetooth device will be stored in the unit's memory). Immediately after pairing, your DN-300Z will automatically **connect** to that Bluetooth device. After that, then you can play audio from it.
- **If you have previously paired your Bluetooth device with your DN-300Z**, please see [Connecting and Playing a Bluetooth Device](#).

## Pairing a Bluetooth Device

**To pair your Bluetooth device to the unit (the first time):**

1. If the unit is off, press the **Power Button** to power it on.
2. Make sure your desired Bluetooth device is has its Bluetooth connectivity on and is within range.
3. If the selected media type is not **BT**, select it (described in [Selecting the Media Playback Mode](#)).
4. Press and hold the **Pairing Button** on the unit for 1 second. **Pairing...** will appear in the **display**.
5. On your Bluetooth device, enter its Bluetooth settings menu, and select **DN-300Z**. **Pairing OK** will appear in the **display**, and your Bluetooth device will automatically connect to the unit. Some older Bluetooth devices may require you to enter a PIN. If this is the case, enter **0000** as the PIN.)

**Note:** The unit will “remember” up to **8** Bluetooth devices. If you connect an additional Bluetooth device after that, the earliest-connected one will be deleted from the unit's memory to allow it to remember the newest one.

**To delete all paired Bluetooth devices from the unit's memory:** With the unit's power off, press and hold the **Device Select Button** on the unit, and press the **Power Button** to turn the unit on.

## Connecting and Playing a Bluetooth Device

**To connect your Bluetooth device to the unit (after pairing it once):**

1. If the unit is off, press the **Power Button** to power it on.
2. Make sure your desired Bluetooth device is has its Bluetooth connectivity on and is within range.
3. If the selected media type is not **BT**, select it (described in [Selecting the Media Playback Mode](#)). **Searching...** will appear in the **display**, and the unit will automatically connect to the last-connected Bluetooth device.

To connect a different Bluetooth device instead:

- i. Press the **Device Select Button** on the unit. **SelectDevice** will appear in the **display**.
  - ii. To move through the list of paired Bluetooth devices, turn the **Jog Dial** on the unit, or use the “up” and “down” **Cursor Buttons** on the remote control.
  - iii. To select the desired Bluetooth device, press the **Jog Dial** on the unit, or press the **Enter Button** on the remote control. The Bluetooth device will automatically connect with the unit.
4. To start playback, press the **Play** button on your Bluetooth device's audio player.

**Important:** Inserting a CD will cause the unit to enter CD Mode automatically.

**To disconnect your Bluetooth device**, enter its Bluetooth settings menu, and disconnect from **DN-300Z**.

## Playing Audio from an External Device

To play audio on an external device (e.g., smartphone, computer, portable music player, etc.) connected to the Aux In:

1. If the unit is off, press the **Power Button** to power it on.
2. Connect the 1/8" (3.5 mm) stereo/headphone output of your external device to the **Aux In**.
3. Select **AUX** as the media type (described in [Selecting the Media Playback Mode](#)). If your external device is connected, **AUX Connected** will appear in the **display**. If your external device is not connected, **AUX Disconnect** will appear in the **display**.
4. To start playback, press the **Play** button on your external device.

### Important:

All buttons except for **Power**, **Media**, and **Eject** will be locked/disabled.

When **AUX Disconnect** is shown in the **display**, inserting a CD will cause the unit to enter CD Mode automatically.

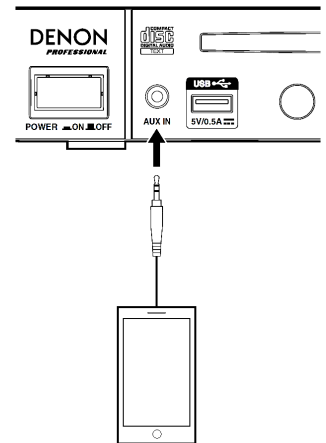

## Using the Radio

### To use the radio:

1. If the unit is off, press the **Power Button** to power it on.
2. Select **FM** or **AM** as the media type (described in [Selecting the Media Playback Mode](#)). The audio from the broadcast will start automatically.

**Important:** Make sure you have properly connected the FM and AM antennae and set the **Tuner Region Select Switch** to the correct setting, as described in the [Setup / Connection Diagram](#).

3. To select a radio station, use the **Tuning Buttons** on the unit or remote control. To jump to the previous or next station with clear reception, press and hold the button for more than 1 second.

In FM/AM Mode, you can perform any of the following operations:

- **To turn Auto Mute on or off**, press the **Auto Mute** button on the unit or remote control. When enabled, a station will be muted if its reception is not clear enough, and **Low Signal** will appear in the **display**.
- **To select a station's preset number**, turn the **Jog Dial** on the unit, or press one of the **Skip Buttons** on the remote control.

Alternatively, press one of the **Number Buttons (0–9)** on the unit or remote control to enter the desired preset number. If the preset number is two digits, press the buttons in succession (e.g., **1** then **2** for Preset 12) within 1 second.

- **To save a station to a preset number:**
  1. Select the desired station.
  2. Press the **Memory** button on the unit or remote control.
  3. Use the **Number Buttons (0–9)** on the unit or remote control to enter the desired preset number.
  4. Press the **Jog Dial** on the unit, or the **Enter Button** on the remote control. When the station is saved successfully, **Stored** will appear in the **display**. (This will overwrite the station previously saved to that preset number)

- **To automatically scan and save multiple stations to preset numbers:**

1. Select a station with clear reception.
2. Press the **Auto Preset** button.
3. Turn the **Jog Dial** on the unit or press one of the **Skip Buttons** on the remote control to select **OK** to continue or **Cancel** to cancel the operation.
4. Press the **Jog Dial** on the unit or the **Enter Button** on the remote control. The unit will automatically scan for stations with clear reception and save them to preset numbers. When the process is completed successfully, **Stored** will appear in the **display**. If stations could not be saved to the preset memory, **Not Stored** will appear in the **display**.

- **To delete a station from a preset number:**

1. Select the desired preset number.
2. Press and hold the **Memory Button** on the unit or remote control. **DelOneMemory** will appear in the **display**.
3. Turn the **Jog Dial** on the unit or press one of the **Skip Buttons** on the remote control to select **OK** to continue or **Cancel** to cancel the operation.
4. Press the **Jog Dial** on the unit or the **Enter Button** on the remote control. When the station is deleted, **CH## Deleted** will appear in the **display**.

- **To delete all stations from all preset numbers:**

1. Press and hold the **Auto Preset** button on the unit or remote control. **DelAllMemory** will appear in the **display**.
2. Turn the **Jog Dial** on the unit or press one of the **Skip Buttons** on the remote control to select **OK** to continue or **Cancel** to cancel the operation.
3. Press the **Jog Dial** on the unit or the **Enter Button** on the remote control. When all stations have been deleted, **All Deleted** will appear in the **display**.

**Important:**

Inserting a CD will cause the unit to enter CD Mode automatically.

The preset memory can hold up to **20** FM station and **20** AM stations.

If the preset memory reaches its 20-station limit during the Auto Preset process, the process will stop.

If you cannot receive a good broadcast signal, we recommend installing an outdoor antenna. For details, inquire at the retail store where you purchased the unit.



When you receive a clear a broadcast signal, fix the antenna with tape in a position where the noise level is minimal.

## Additional Functions

### Panel Lock

Use the Panel Lock feature to prevent accidental changes to the unit. When Panel Lock is activated, all buttons except for the **Power Button** and **Text/Lock** button are locked/disabled on the unit. (The remote control will still function normally.)

**To activate or deactivate Panel Lock**, press and hold the **Text/Lock** button on the unit or remote control.



- When activated, **P-Lock On** and  will appear in the **display**.
- When deactivated, **P-Lock Off** will appear in the **display**, and  will disappear.

### Power-On Play

Use the Power-On Play feature to set the unit to automatically start playback of the last media it was playing when it was turned off. Playback will start from the first track or audio file of the media.

**Important:** Power-On Play will not work if the previously played media was in Aux or Bluetooth (**BT**) Mode.

**To activate or deactivate Power-On Play**, press and hold the **Pwr On Play** button on the unit or remote control.

- When activated, **P-OnPlay On** and  will appear in the **display**.
- When deactivated, **P-OnPlay Off** will appear in the **display**, and  will disappear.

## Other Information

### CDs

When playing audio CDs, note the following:

- DN-300Z can play **Music CDs** and **CD-R discs**. Both are usually marked with the **Compact Disc Digital Audio** logo (see image).
- Do not play discs in non-circular shapes (heart-shaped discs, octagonal discs, etc.; see image) or discs that have been repaired with adhesive or tape. These can damage the unit.
- DN-300Z can play finalized discs only. (Finalization is the process that makes recorded CD-R discs playable on compatible players.)
- Depending on the software used to burn a CD (or other conditions), some CDs may not play correctly.



When playing CDs with audio files, note the following:

- The writing software format must be **ISO9660 Level 1**.
- You can have up to **300** folders and up to **8** folder levels, including the root directory.
- You can have up to **300** audio files. If the CD contains more than **300** files, some audio files may not play or appear correctly.
- File names, folder names, and text characters can use up to **255** characters. Only uppercase letters, lowercase letters, numbers, and symbols can be displayed. Japanese file names will not be shown.
- Copyright-protected files might not play properly and/or may appear as **Unknown File**.
- Depending on the software used to burn a CD (or other conditions), some files may not play or appear correctly.
- When playing audio files on a CD, DN-300Z supports the following tag data:
  - **ID3 tags:** Version 1.x and 2.x
  - **META-tags:** compatible with title, artist, and album names
  - **Sample rate:** 44.1 kHz
  - **Bit rate:** 32 kbps to 320 kbps
  - **Format:** MPEG1 Audio Layer 3
  - **File extension:** .mp3

Be careful not to scratch discs when removing them from their cases. Do not bend or heat discs, and do not enlarge the hole in the center of the disc. Do not write on the labeled surface of the disc or attach new labels to discs.

If fingerprints, dirt, or condensation are on a disc, clean it with a commercially available disc cleaning set or a soft, dry cloth. Gently wipe it from the inside towards the outside, not in a circular motion. Do not use record spray, antistatic agents, benzene, thinner, or other solvents.

After using discs, remove them from the unit and store them in their cases to protect them from dust, scratches, warping, etc. Do not store discs in places exposed to long periods of direct sunlight or places exposed to heat, dust, humidity, etc.

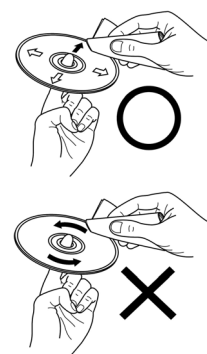

### USB Devices / SD Cards

When playing audio files on a USB device or SD card, note the following:

- DN-300Z does not charge any connected USB device and does not support USB hubs, USB extension cables, or SD card readers.
- DN-300Z supports USB devices that are mass storage class or compatible with MTP.
- DN-300Z supports SD or SDHC cards with a maximum capacity of up to **32 GB**.
- DN-300Z supports **FAT16** or **FAT32** file systems only.
- You can have up to **999** folders and up to **8** folder levels, including the root directory.



- You can have up to **999** audio files. If the USB device or SD card contains more than **1000** files, some audio files may not play or appear correctly.
- File names, folder names, and text characters can use up to **255** characters. Only uppercase letters, lowercase letters, numbers, and symbols can be displayed. Japanese file names will not be shown.
- Copyright-protected files might not play properly and/or may appear as **Unknown File**.

When playing audio files on a USB device or SD card, DN-300Z supports the following tag data:

- **ID3 tags:** Version 1.x and 2.x
- **AAC-tags:** compatible with title, artist, and album names
- **for MP3 files:**
  - **Sample rate:** 44.1 kHz
  - **Bit rate:** 32 kbps to 320 kbps
  - **Format:** MPEG1 Audio Layer 3
  - **File extension:** .mp3
- **for AAC files:**
  - **Sample rate:** 44.1 kHz
  - **Bit rate:** 32 kbps to 320 kbps
  - **Format:** Advanced Audio Codec
  - **File extension:** .m4a
- **for WAV files:**
  - **Sample rate:** 44.1 kHz
  - **Bit rate:** 16 bit
  - **Format:** Linear PCM
  - **File extension:** .wav

## Audio File Playback Order

When playing audio files stored within multiple folders, the playback order of each folder is automatically set when the unit reads the media. The files in each folder will play in the same order in which they were added to the media. (This order may appear differently on your computer and/or in your software than it does on the unit.)

The folder structure also determines the playback order:

- **For audio files on a CD-R**, files in *all* folders on the *first* level will play, then files in *all* folders on the *second* level, then on the *third* level, and so on.
- **For audio files on a USB device or SD card**, files in the *first* folder on the *first* level will play, then files on the *second* level in that same folder, then files on the *third* level in that same folder, and so on. After playing all files on all levels of that first folder, the same process will continue for files in the *second* folder on the *first* level.

## Folders and Music Files

When placing audio files on your CD, USB device, or SD card, it is useful to keep your files organized in folders. This not only makes it easier to locate files, but it also affects the playback order of the files (as described in [Audio File Playback Order](#)).

The image here illustrates how folders are structured into *levels* on your media.

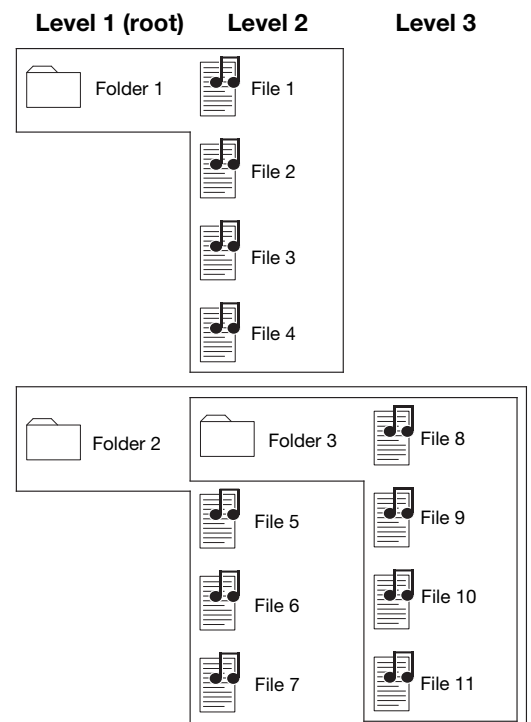

## Troubleshooting

If you encounter a problem, do the following:

- Make sure all cables, devices, antennae, and/or media are properly and securely connected.
- Make sure you are using the unit as described in this *User Guide*.
- Make sure your other devices or media are working properly.
- If you believe the unit is not working properly, check the following table for your problem and solution.

Problem	Solution	Please see:
Power does not turn on.	Make sure the unit is connected to a power outlet.	<a href="#">Setup / Connection Diagram</a>
CD cannot be inserted into <b>CD Slot</b> .	Make sure the unit is connected to a power outlet and that it is powered on. Press the <b>Eject Button</b> to make sure a CD is not already in the <b>CD Slot</b> .	<a href="#">Setup / Connection Diagram</a>
<b>No Disc</b> appears even when a CD is inserted.	Press the <b>Eject Button</b> to eject the CD and insert it again.	
A specific section of the CD does not play properly.		
Playback does not start even after pressing the <b>Play</b> button.	Clean the CD with a dry cloth or commercial CD cleaner. Insert a different CD.	<a href="#">Other Information &gt; CDs</a>
The unit does not produce any sound, or the sound is distorted.	Make sure all cable, device, or media connections are secure and correct. Make sure none of the cables are damaged. Make sure the settings on your amplifier, mixer, etc. are correct.	<a href="#">Setup / Connection Diagram</a>
The unit cannot play a CD-R.	Make sure the CD-R has been finalized properly. Make sure the CD-R is of good quality. Clean the CD with a dry cloth or commercial CD cleaner. Make sure the CD uses a folder structure that the unit supports: up to <b>300</b> folders (up to <b>8</b> folder levels, including the root) and up to <b>300</b> files. Make sure the CD-R contains MP3 files. The unit cannot play other files on CD-R.	<a href="#">Other Information &gt; CDs</a>
The CD will not eject.	Press and hold the <b>Eject Button</b> while turning on the unit.	
Using the radio produces noise.	Make sure the antennae are properly connected. Change the position or orientation of the antennae. Use an outdoor FM antenna. Move the AM loop antenna away from the unit. Move the antennae away from other cables.	<a href="#">Setup / Connection Diagram</a>



Problem	Solution	Please see:
Audio from my Bluetooth device does not play through the unit.	<p>Make sure you have properly paired and connected your Bluetooth device.</p> <p>Make sure you have properly connected the Bluetooth antenna to the terminal on the rear panel.</p> <p>Improve the Bluetooth signal reception by moving your Bluetooth device closer to the unit. Also, remove obstacles (walls, furniture, etc.) so there is a clear line of sight between your Bluetooth device and the unit.</p>	<p><a href="#">Setup / Connection Diagram</a> and <a href="#">Operation &gt; Playing Audio from a Bluetooth Device</a></p>
Connecting my Bluetooth device to the unit requires a PIN.	Enter <b>0000</b> as the PIN. (Some older Bluetooth devices may require you to enter a PIN.)	<a href="#">Operation &gt; Playing Audio from a Bluetooth Device</a>
<b>No Device</b> appears even when a USB device or SD card is inserted.	<p>Disconnect and reconnect the USB device or SD card to make sure it is securely inserted.</p> <p>Make sure the USB device is of a mass storage class or compatible with MTP.</p> <p>Make sure the USB device or SD card is formatted using a <b>FAT16</b> or <b>FAT32</b> file system.</p> <p>Do not use a USB hub, USB extension cable, or SD card reader.</p> <p>The unit does not supply power to USB devices. If your USB device requires a power source, connect it to one.</p> <p>Not all USB devices or SD cards are guaranteed to work; some may not be recognized.</p>	<a href="#">Other Information &gt; USB Devices / SD Cards</a>
Files on a USB device or SD card do not appear.	<p>Make sure the files are of a supported file format. Files that are not supported by this unit will not appear.</p> <p>Make sure the USB device or SD card uses a folder structure that the unit supports: up to <b>999</b> folders (up to <b>8</b> folder levels, including the root) and up to <b>999</b> files.</p> <p>If your USB device or SD card is partitioned, make sure the files are in the first partition. The unit will not show other partitions.</p>	<a href="#">Other Information &gt; USB Devices / SD Cards</a>
Files on a USB device or SD card cannot play.	<p>Make sure the files are of a supported file format. Files that are not supported by this unit will not appear.</p> <p>Make sure the files are not copyright-protected. The unit cannot play copyright-protected files.</p>	<a href="#">Other Information &gt; USB Devices / SD Cards</a>
File names do not appear properly.	Make sure the files are using only supported characters. Characters that are not supported will be replaced with a “.”	<a href="#">Other Information &gt; USB Devices / SD Cards</a>

## Appendix (English)

### Technical Specifications

Digital Audio System	
<b>System</b>	Media player with tuner
<b>Compatible Media</b>	CD, USB device (mass storage class), SD/SDHC
<b>Supported Device Formats, File Systems</b>	<b>CD:</b> CD-DA, CD-ROM (ISO9660) <b>USB:</b> FAT16, FAT32 <b>SD/SDHC:</b> FAT16, FAT32
<b>Bluetooth Specification</b>	<b>Version:</b> 3.0 <b>Output Class:</b> Class 2 <b>Supported Codec:</b> SBC, MP3, AAC, aptX <b>Supported Profile:</b> A2DP; AVDTP 1.0, AVCTP 1.3, AVRCP 1.0, SSP
<b>Supported File Formats</b>	<b>MP3:</b> (in CD, USB, or SD Mode) <b>Sample rate:</b> 44.1 kHz <b>Bit rate:</b> 32 kbps to 320 kbps and VBR <b>Format:</b> MPEG1 Audio Layer 3 <b>File extension:</b> .mp3
	<b>AAC:</b> (in USB or SD Mode) <b>Sample rate:</b> 44.1 kHz <b>Bit rate:</b> 32 kbps to 320 kbps and VBR <b>Format:</b> Advanced Audio Codec <b>File extension:</b> .m4a
	<b>WAV:</b> (in USB or SD Mode) <b>Sample rate:</b> 44.1 kHz <b>Bit rate:</b> 16 bit <b>Format:</b> Linear PCM <b>File extension:</b> .wav
<b>Number of Channels</b>	2 (stereo), 1 (mono)
<b>Audio Frequency Range</b>	20 Hz – 20 kHz ( $\pm 1.0$ dB)
<b>Signal-to-Noise Ratio</b>	> 95 dB (A-weighted)
<b>Total Harmonic Distortion</b>	< 0.01%
<b>Dynamic Range</b>	> 85 dB
<b>Channel Separation</b>	> 80 dB
Tuner Section	
<b>Receiving Range</b>	<b>North America, South America:</b> <b>FM:</b> 87.50 MHz – 107.90 MHz <b>AM:</b> 20 kHz – 1710 KHz
	<b>Europe and Asia Pacific Region:</b> <b>FM:</b> 87.50 MHz – 108.00 MHz <b>AM:</b> 522 kHz – 1611 KHz
	<b>Japan:</b> <b>FM:</b> 76.00 MHz – 90.00 MHz <b>AM:</b> 522 kHz – 1629 KHz



<b>Tuner Section (continued)</b>	
<b>Usable Sensitivity</b>	<b>FM:</b> 30 dBuV/m <b>AM:</b> 60 dBuV/m
<b>Channel Separation</b>	20 dB (1 kHz)
<b>Signal-to-Noise Ratio</b>	<b>FM:</b> > 40 dB <b>AM:</b> > 30 dB
<b>Total Harmonic Distortion+Noise</b>	3.0%
<b>Outputs</b>	
<b>Analog Out L/R (unbalanced)</b>	<b>Type:</b> RCA terminal <b>Load impedance:</b> > 10 kΩ <b>Output level:</b> 2 Vrms / at 10 kΩ load
<b>Analog Out L/R (balanced)</b>	<b>Type:</b> XLR <b>Load impedance:</b> > 10 kΩ <b>Output level:</b> +4 dBu
<b>Inputs</b>	
<b>Aux In</b>	<b>Type:</b> 1/8" (3.5mm) TRS terminal <b>Input impedance:</b> > 10 kΩ <b>Maximum input level:</b> 1 Vrms <b>Maximum output level:</b> 3 Vrms
<b>Other / General</b>	
<b>File/Folder Limits</b>	<b>Storage capacity:</b> up to 2 TB <b>File size:</b> up to 2 GB <b>File name length:</b> up to 255 characters <b>Number of files:</b> up to 999 (for 1 folder) <b>Number of folders:</b> up to 999 folders (including the root directory) <b>Number of folder levels:</b> up to 8 (including the root directory) <b>Folder name length:</b> up to 255 characters
<b>Power</b>	<b>USA and Canada:</b> 120 V AC, 60 Hz <b>Europe and Asia Pacific Region:</b> 230 V AC, 50/60 Hz <b>Japan:</b> 100 V AC, 50/60 Hz <b>Power consumption:</b> 30 W
<b>Environmental Conditions</b>	<b>Operating temperature:</b> 41 – 95 °F (5 – 35 °C) <b>Operating humidity:</b> 25 – 85%, no condensation
<b>Dimensions</b> (width x depth x height)	19.00" x 13.66 x 1.73" / 483 mm x 347 mm x 44 mm (with rack ears) 17.09" x 13.66 x 1.73" / 434 mm x 347 mm x 44 mm (without rack ears)
<b>Weight</b>	7.94 lbs. / 3.6 kg

## Dimensions

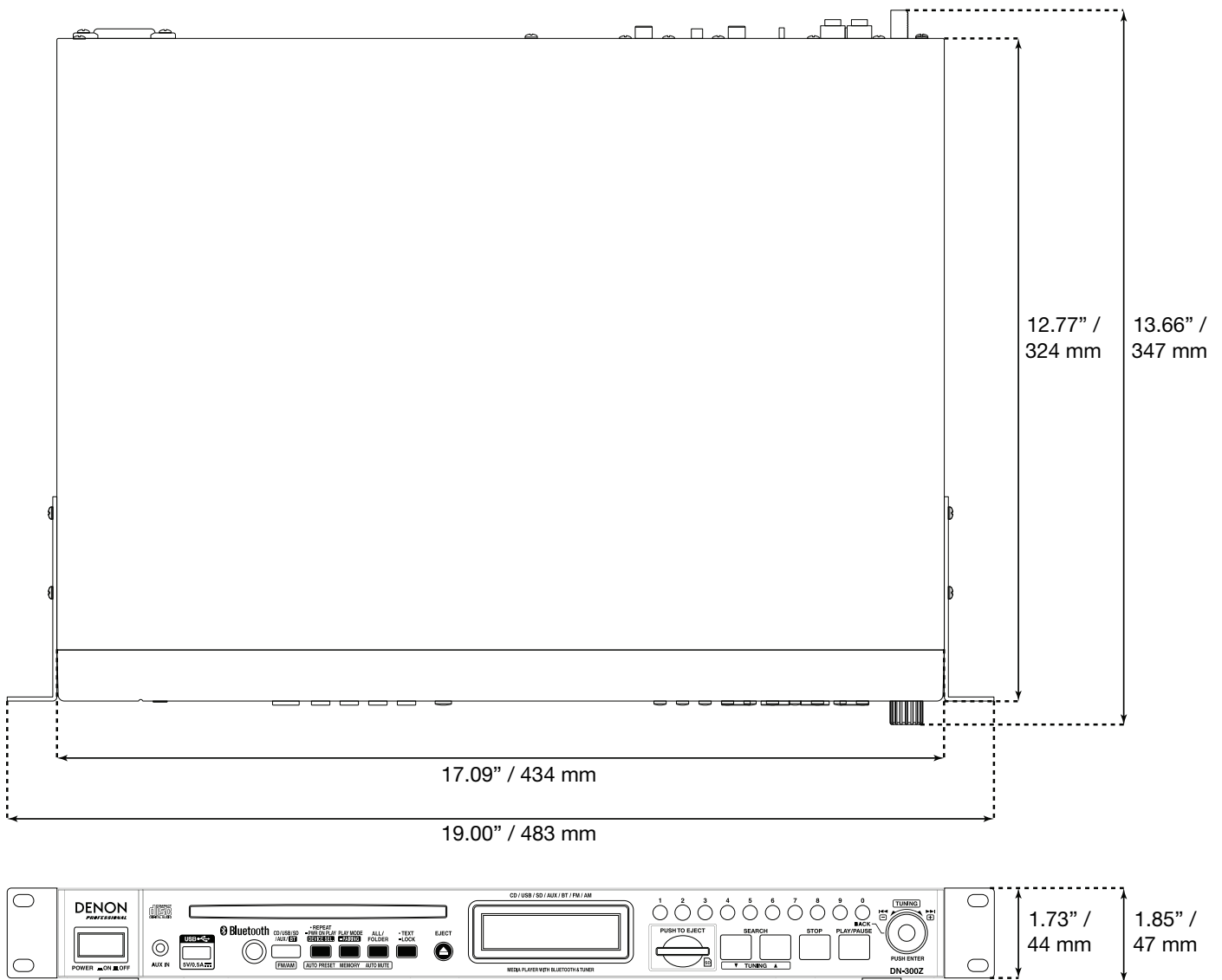

## Trademarks and Licenses

Denon is a trademark of D&M Holdings Inc., registered in the U.S. and other countries.

SD and SDHC are trademarks or registered trademarks of SD-3C, LLC in the United States, other countries or both.

The *Bluetooth* word mark and logos are owned by the Bluetooth SIG, Inc.

All other product or company names are trademarks or registered trademarks of their respective owners.

**denonpro.com**