

CDD-LIVE! Series User Guide

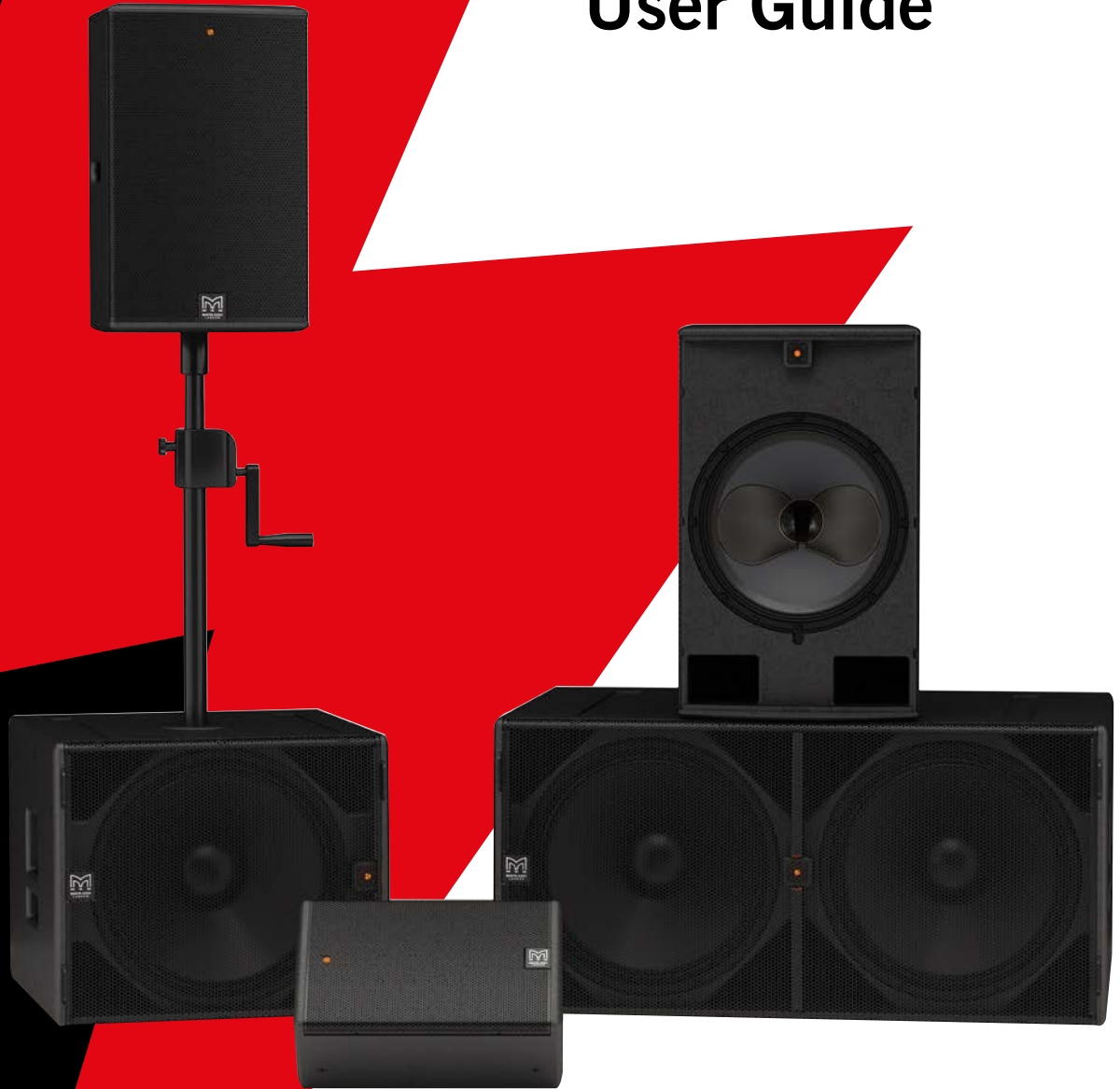

 **CDD™ LIVE!**

THE SOUND OF THINGS TO COME



Safety Information

Unpacking the Units

After unpacking the unit, please check it carefully for any damage. If any is found, immediately notify the carrier concerned - you, the consignee, must instigate any claim. Please retain all packaging in case you need to return the unit.



Please think of our environment

When the product has reached the end of its useful life, please dispose of it responsibly through a recycling centre.

Electrical Safety

! READ THIS FIRST!

Important Safety Instructions

- Read these Instructions.
- Keep these instructions.
- Heed all warnings.
- Follow all instructions.
- Do not block any ventilation openings; Install in accordance with the manufacturer's instructions.
- Do not install near any heat source such as radiators, heat registers, stoves, or other such apparatus that produce heat.
- Do not defeat the purpose of the grounding type plug, a grounding plug has two blades and a grounding prong, the third prong is provided for your safety.
- If the provided plug does not fit your outlet consult an electrician for a replacement type.
- Protect power cords from being walked on or pinched particularly a plugs, convenience receptacles, and the point where they exit the apparatus.
- Only use attachments and accessories specified by Martin Audio Ltd.
- Use only with the cart, stand, tripod, bracket, flying hardware specified by the manufacturer or sold with the apparatus, when a cart is used, use caution when moving the cart/apparatus combination to avoid injury from tripping.
- Unplug the apparatus during lightning storms or when unused for long periods of time.
- Refer all servicing to qualified service personnel. Servicing is required when the apparatus has been damaged in any way, such as a power supply cord or plug is damaged, does not operate normally, or has been dropped.
- The means of disconnection from the mains is the appliance coupler or mains plug. one of these devices must remain accessible when the apparatus is in use.



Caution

To reduce the risk of electric shock do not remove the back cover. There are no user serviceable parts inside the unit. Refer servicing to qualified service personnel only. Call Martin Audio, Ltd on +44 (0) 1494 535312 or e-mail: info@martin-audio.com for service.



Approvals



SAFETY	IEC60065:2002 + A1:2006
Environmental	IP24 When factory supplied and with appropriate cowls, and used with IP rated mains connectors
Country of origin	United Kingdom
EMC EMISSION	EN55103-1:2009 + A1:2012
EMC IMMUNITY	EN55103-2:2009
FCC CFR47	PART 15B-2015
ICES-003:2012	

This is a class A product. In a domestic environment this product may cause radio interferences in which case the user may be required to take adequate measures.

Safety Rules

- This CDD-Live or SXP product must be powered exclusively by an earth connected mains socket in electrical networks compliant to the IEC 364 or similar local rules. It is absolutely vital that the user verifies this fundamental safety requirement. If you are in any doubt, get the installation checked by qualified personnel before use
- The means of disconnection from the mains is the mains plug. We strongly recommend that you power the CDD-Live or SXP by a professionally installed mains supply with an easily accessible on/off switch or circuit breaker.
- Before powering the CDD-Live or SXP, via Neutrik® PowerCON TRUE1 connector, make sure that the unit is supplied with the correct mains operating voltage: 100 - 240V ~ 50 - 60Hz
- The CDD-Live and SXP products are protected by internal fuses located on the main amplifier board Designated F500

CDD-Live 8	1 x T4AH 250V, 5 x 20mm
CDD-Live 10/12	1 x T6.3AH 250V, 5 x 20mm
SXP118	1 x T6.3AH 250V, 5 x 20mm
SXP218	2 x T6.3AH 250V, 5 x 20mm

- Do not use this unit if the electrical power cord is frayed or broken
- Do not remove the cover. Removing the cover will expose you to potentially dangerous voltage

Lire Avant De Commencer!

Consignes De Sécurité Importantes

- Lire ces consignes.
- Conserver ces instructions.
- Observer tous les avertissements.
- Suivre toutes les consignes.
- Ne pas utiliser cet appareil à proximité de l'eau.
- Nettoyer uniquement avec un chiffon sec.
- Ne pas installer à proximité d'une source de chaleur telle qu'une flamme nue, un radiateur, une bouche de chaleur, un poêle ou d'autres appareils (dont les amplificateurs) produisant de la chaleur.
- Ne pas détériorer la sécurité de la fiche polarisée ou de la fiche de terre. Une fiche polarisée comporte deux lames dont l'une est plus large que l'autre. Une fiche de terre comporte deux lames et une troisième broche de mise à la terre. La lame la plus large ou la troisième broche assure la sécurité de l'utilisateur. La fiche fournie ne s'adapte pas à la prise électrique, demander à un électricien de remplacer la prise hors normes.
- Protéger le cordon d'alimentation afin que personne ne marche dessus et que rien ne le pince, en particulier au niveau des fiches des prises de courant et du point de sortie de l'appareil.
- Utiliser uniquement les accessoires spécifiés par le fabricant.
- Utiliser uniquement avec un chariot, un trépied, un support ou une table spécifiée par le fabricant ou vendu avec l'appareil. Si un chariot est utilisé, déplacer l'ensemble chariot-appareil avec précaution afin de ne pas le renverser, ce qui pourrait entraîner des blessures.
- Débrancher l'appareil pendant les orages ou quand il ne sera pas utilisé pendant longtemps.
- Confier toute réparation à du personnel qualifié. Des réparations sont nécessaires si l'appareil est endommagé d'une façon quelconque, par exemple : cordon ou prise d'alimentation endommagé, liquide renversé ou objet tombé à l'intérieur de l'appareil, exposition de l'appareil à la pluie ou à l'humidité, appareil qui ne marche pas normalement ou que l'on a fait tomber.
- La prise secteur ou un coupleur d'appareil électrique doit rester facilement utilisable.

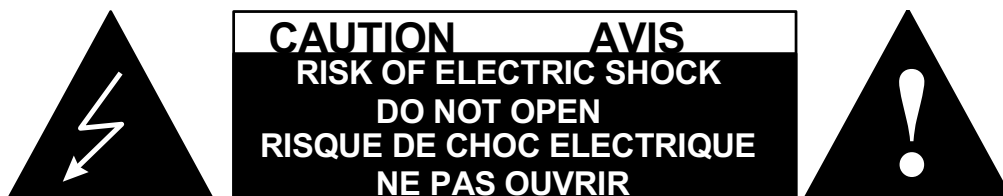



Contents

Safety Information	1
Unpacking the Units.....	1
Electrical Safety	1
Important Safety Instructions	1
Caution.....	1
Approvals	2
Safety Rules.....	2
Lire Avant De Commencer!.....	3
Consignes De Sécurité Importantes.....	3
Introduction.....	6
Coaxial Differential Dispersion Technology	6
Dante™.....	6
Quick Start	8
CDD-Live and SXP Range.....	9
CDD-LIVE and SXP Accessories.....	9
The Range in Detail.....	10
CDD-LIVE 8	10
CDD-LIVE 12	11
CDD-LIVE 15	12
SXP118	13
SXP218	14
Connections	15
Mains	15
Audio.....	18
Ethernet.....	18
Preset Operation	20
CDD-LIVE 8, CDD-LIVE 12, CDD-LIVE 15	20
SXP118, SXP218	21
Meter Mode.....	21
CDD LIVE8, 12 & 15 Cabinet Configuration.....	22
Grill Removal.....	22
Badge Rotation	24
Rotating Driver.....	24
Dante	26
Dante Controller	27
System Wiring Examples.....	28
1. Basic System	28
2. System with Vu-Net Control	29
3. System with Audio via Dante	30
4. Network Control with Star Configuration.....	31
5. Dante Control with Star Configuration	32



- 6. Integrating with an MLA System..... 33
- 7. MLA Mini with additional SXP218 subwoofers..... 34
- 8. MLA Compact Combined with SXP218 35
- Vu-Net..... 36**
 - Introduction 36
 - Device Discovery 38
 - Firmware Updates 54
 - Restoring a CDD-Live or SXP module that is set to boot mode..... 59
- Module Reset Procedure 64**
- System Deployment..... 65**
 - Safety 65
 - Pole Mount 65
 - Wall Mounting 68
 - Ceiling Mount..... 73
 - Universal Bracket..... 76
 - Yoke Mounting..... 80
 - Eye Bolt Mounting 84
- Upgrading to Weatherised 85**
 - CDD-LIVE8, 12 & 15..... 85
 - SXP118, SXP218 (CSX-LIVE118 & CSX-LIVE218) 94
- Current Draw and Thermal Dissipation 98**
 - CDD-LIVE8 98
 - CDD-LIVE12 98
 - CDD-LIVE15 98
 - SXP118 98
 - SXP218 98
- Specifications..... 99**
 - CDD-Live 8..... 99
 - CDD-Live 12..... 100
 - CDD-Live 15..... 101
 - SXP118 102
 - SXP218 103
- Technical Drawings 104**
 - CDD-Live 8..... 104
 - CDD-Live 12..... 104
 - CDD-Live 15..... 105
 - SXP118 105
 - SXP218 106
- Warranty..... 107**



Introduction

Most self-powered portable loudspeakers have been underpowered, light-duty systems or very high-end systems out of reach of many users. Now, with the multi-purpose CDD-LIVE! Series and SXP Subwoofers, Martin Audio brings everything rental companies, system integrators and musicians require from a self-powered loudspeaker into sharp focus.

Comprising three full-range models and two SXP subwoofers, CDD-LIVE! Covers practically all professional stand-alone and distributed applications — from sound reinforcement and monitoring for live bands, DJ's and corporate events, to installations in dance clubs, ballrooms, theatres and performing arts centres.

Combining the 'point-source' benefits of coaxial designs with the consistent coverage of Differential Dispersion technology, CDD-LIVE! Full range systems are optimised for optimum real-world coverage exhibiting wide horizontal dispersion close to the speaker at the bottom of the vertical dispersion which narrows to the top of the vertical coverage to ensure excellent power delivery right to the back of the room. Thus all corners of the audience experience the same superb sonic quality.

On-board Class D amplification, DSP and Dante™ Digital Audio networking assure simplicity of stage set-up and efficient installation, while tour-grade enclosures and comprehensive mounting options — including pole mount, wall brackets, yokes and rigging inserts — provide maximum flexibility in deployment.

With sonic consistency across the range, a rectangular coverage footprint and a multitude of deployment options, CDD-LIVE! is truly versatile — a professional self-powered solution for a huge host of audio applications.

Coaxial Differential Dispersion Technology

Introduced by Martin Audio with the launch of the CDD Installation Series of speakers, full-range models feature unique, patented Coaxial Differential Dispersion™ technology. CDD systems augment the 'point-source' benefits of coaxial drivers with the consistency of coverage which Differential Dispersion technology can deliver.

Non-coaxial systems can suffer from uneven frequency response in the crossover region because of interference between the LF and HF sections; depending on the listening position, this causes off-axis variations, particularly close to the loudspeaker. In contrast, coaxial systems aim to sum LF and HF contributions at all positions off-axis, even close-up.

A disadvantage of conventional coaxial devices can be HF beaming, where the HF dispersion reduces at higher frequencies. This is primarily because the HF energy emerges through a narrow tube in the pole-piece of the magnet system. CDD Series coaxial devices overcome this by the use of a static waveguide that merges seamlessly with the unique cone shape — maintaining the dispersion pattern even at very high frequencies.

A Differential Dispersion horn has a trapezoidal dispersion pattern in both vertical and horizontal planes which covers the target area more evenly than a system with a conventional, fixed dispersion type horn. With a conventional horn, the speaker is usually placed above head height and aimed towards the centre of the audience. This produces an imperfect coverage pattern which misses out some areas — particularly side areas close to the loudspeaker.

In contrast, a CDD Coaxial Differential Dispersion system produces a rectangular coverage pattern extending to all corners of the audience area, while wide horizontal coverage is achieved very close to the loudspeaker. The consistency of frequency response and SPL thus achieved throughout the audience area is exceptional. The improved coverage close to the source also means that CDD speakers can often be spaced further apart, reducing overall speaker count.

CDD-Live marries this ground-breaking technology with a class D amplifier in a robust ready enclosure to complement the CDD installation range with a range suitable for portable applications or fixed installations where a powered product is required.

Dante™

All models in the CDD-Live and SXP range feature a class D amplifier with on-board DSP and input to the systems can be either balanced line level analogue or Dante™ digital audio. Introduced by Audinate, Dante is an uncompressed, multi-channel digital media networking platform, with near-zero latency and synchronization. Dante has become the preferred digital audio networking solution, a common platform that the industry had been trying to find for many years. It has been adopted by more pro-audio AV manufacturers than any other networking technology. Interoperability is not a dream of the future, but a reality today. Hundreds of Dante-enabled products are available from the world's leading manufacturers making interfacing a system with CDD-Live speakers extremely straightforward over inexpensive, readily available Cat 5 cable.



Setting up a Dante network is simple — even complex networks can be configured easily and quickly, with all devices discovered and displayed in the Dante Controller software. Once setup, the computer running Dante Controller can be removed from the network if desired, with system settings stored in the devices themselves and automatically restored when a device is power-cycled.

Input to a CDD-LIVE Or SXP speaker can be selected to be either analogue, Dante or Auto. In Auto mode the speaker will select the Dante feed if a Dante stream is detected.

Quick Start

CDD-Live and SXP can be set up extremely quickly and easily using a standard analogue audio connection and selecting the correct preset.

This diagram shows the wiring for a basic system; -

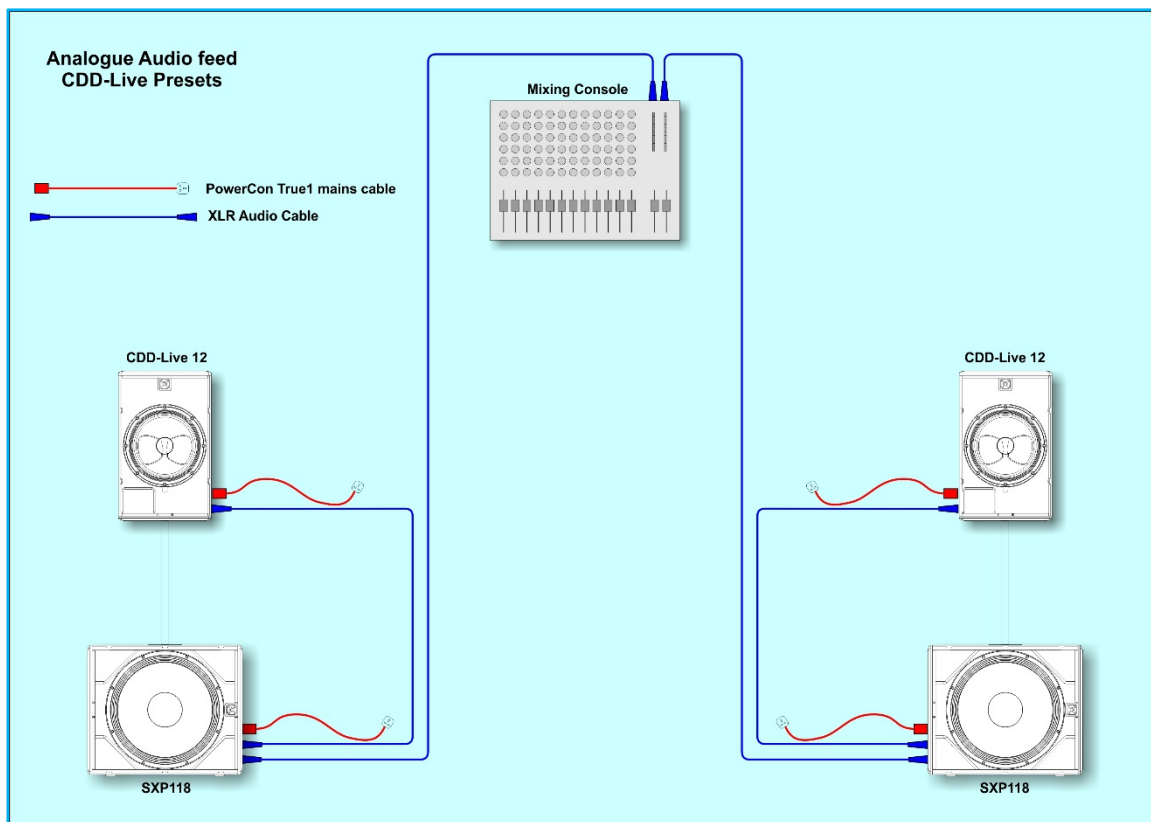

To configure the system, these are the necessary steps; -

1. Connect a mains cable from a nearby mains outlet to the PowerCon True1 mains inlet on all CDD-Live and SXP cabinets. (See the chapter on wiring PowerCon True1 cables for more details) Do not yet turn on power at the socket.
2. Connect an XLR Cable from our audio source; mixer or similar into the SXP sub if used. One cable will be required for left and another for right for a stereo speaker array. If a subwoofer is not used connect straight to the CDD-Live cabinet.
3. Connect a short XLR cable from each SXP Sub to the corresponding CDD-Live cabinet.
4. Turn on your mixing console
5. Turn on your CDD-Live and SXP speakers
6. Select the correct Preset on the back of the SXP and CDD-Live speakers as follows; -

CDD-Live 8, 12, 15 full range (no subwoofer)	Preset 1
CDD-Live 8, 12, 15 with Subwoofer (use this in the above example)	Preset 2
CDD-Live 8, 12, 15 stage monitor mode (see chapter on rotating driver)	Preset 3
SXP118, 218 with CDD-Live 12, 15 (use this in the above example)	Preset 1
SXP118, 218 with CDD-Live 8	Preset 2



CDD-Live and SXP Range

The CDD-Live range consists of three full-range models and SXP two sub woofers.

- **CDD-Live 8** Ultra-compact featuring an 8" low frequency element and a coaxial 1" compression driver. Two channels of Class D amplification deliver 1000W peak to the LF and 300W peak to the HF.
- **CDD-Live 12** High performance featuring a 12" LF driver with coaxial 1" compression driver. The on-board Class D amplification delivers 2000W peak to the LF and 500W peak to the HF.
- **CDD-Live 15** Very high output system with a 15" low frequency and 1.4" Compression Driver. Amplification is 2000W peak to the LF and 500W peak to the HF.
- **SXP118** (Formerly CSX-Live 118) A Compact single 18" sub with extended response down to 43Hz with 2000W peak power from the on-board Class D amplifier
- **SXP218** (Formerly CSX-Live218) Ultimate Subwoofer performance with a twin 18" lone-excursion drivers in a reflex enclosure and a massive 4000W of power from the Class D amplifier for colossal sub frequency performance down to 35Hz

For full system specifications please see the Specifications chapter on page.

CDD-LIVE and SXP Accessories

There is a comprehensive range of accessories to accompany the range to allow deployment in a host of ways from pole mounting on a standard speaker stand or distance bar, ceiling mount for the CDD-Live 8, wall mount for the CDD-Live 8 and 12, Yoke brackets for wall, ceiling or flown applications in either portrait or landscape modes and a universal bracket which offers flying options with easily adjustable up or down tilt in either portrait or landscape and when used in conjunction with a pole mount adaptor the universal bracket allows mounting on a speaker stand with adjustable up and down tilt. Finally, the range features threaded inserts, M8 for the CDD-Live cabinets and M10 for the SXP enclosures which allow flown applications using shouldered eye bolts and steel wire or chain from suitable points in the venue.

The CDD-Live family can be fitted with cowls and weatherised grills for use outdoors in virtually any weather conditions and are rated to IP24.

This modification can be ordered as a kit of parts.

- CDDLK8** For CDD-Live 8
- CDDLK12** For CDD-Live12
- CDDLK15** For CDD-Live 15
- CDDLK118/218** For SXP118
- CDDLK118/218** For SXP218

The CDD-Live and SXP are available with or without the rain cowl ready fitted, these can be distinguished by the visibility of the IP24 Marking. Shown are the different identification labels.



Tough canvas transit covers are also available to protect the cabinets from wear and tear out on the road. Part numbers are as follows; -

- CDDLTC8** CDD-LIVE 8 Transit Cover
- CDDLTC12** CDD-LIVE 12 Transit Cover
- CDDLTC15** CDD-LIVE 15 Transit Cover
- CDDLTC118** SXP118 Transit Cover
- CDDLTC218** SXP218 Transit Cover

The Range in Detail

CDD-LIVE 8



The CDD-LIVE 8 is an ultra-compact two-way system featuring an 8" (200mm) LF/1" (25mm) exit HF Coaxial Differential Dispersion driver which can be easily rotated for horizontal or vertical orientation. It's very small size gives no indication of its high output capability. As a stand-alone loudspeaker, it has a multitude of professional applications — from distributed sound reinforcement, HoW and AV events to front fill/infill and use as a micro stage monitor. Its two-channel on-board Class D amplifier module delivers 1000W LF + 300W HF peak output to the drivers and its sophisticated DSP section performs EQ, crossover and limiter functions as well as driver optimisation.

CDD-Live 8 Accessories

- WB6/8B Wall Mount Installation bracket
- CDDCB6/8B Ceiling Mount Bracket (landscape mode only)
- CDDLUB8B Universal Bracket Assembly
- CDDL YA8B Yoke Assembly
- ASF20071 Wind-up distance pole (for use in conjunction with the SXP118)
- ASF20045 35mm Stand Adaptor (for use with the Universal Bracket)
- HTK00003 8mm Shouldered Eye Bolt
- CDDLTC8 CDD-LIVE 8 Transit Cover

CDD-LIVE 12



The CDD-LIVE 12 is a high-performance system designed for professional applications that require high output levels from a very compact enclosure. Its high-specification 12" (300mm) LF/1" (25mm) exit HF Coaxial Differential Dispersion driver delivers perfect sound across the audience over medium-throw distances. The LF driver has a 2.5" (65mm) voice coil and efficient motor with an aluminium demodulating ring to minimise distortion, while the HF driver utilises a 1.75" (44mm) polyimide diaphragm and features a low-compression phase plug to reduce non-linearity. The on-board fan-cooled, two-channel Class D amplifier module delivers a total of 2500W peak output to the LF and HF drivers.

CDD-Live 12 Accessories

- WB10/12B Wall Mount Installation bracket
- ASF20046 Universal Bracket Assembly
- CDDLIA12B Yoke Assembly
- ASF20071 Wind-up distance pole (for use in conjunction with the SXP118)
- ASF20045 35mm Stand Adaptor (for use with the Universal Bracket)
- HTK00003 8mm Shouldered Eye Bolt
- CDDLTC12 CDD-LIVE 12 Transit Cover

CDD-LIVE 15

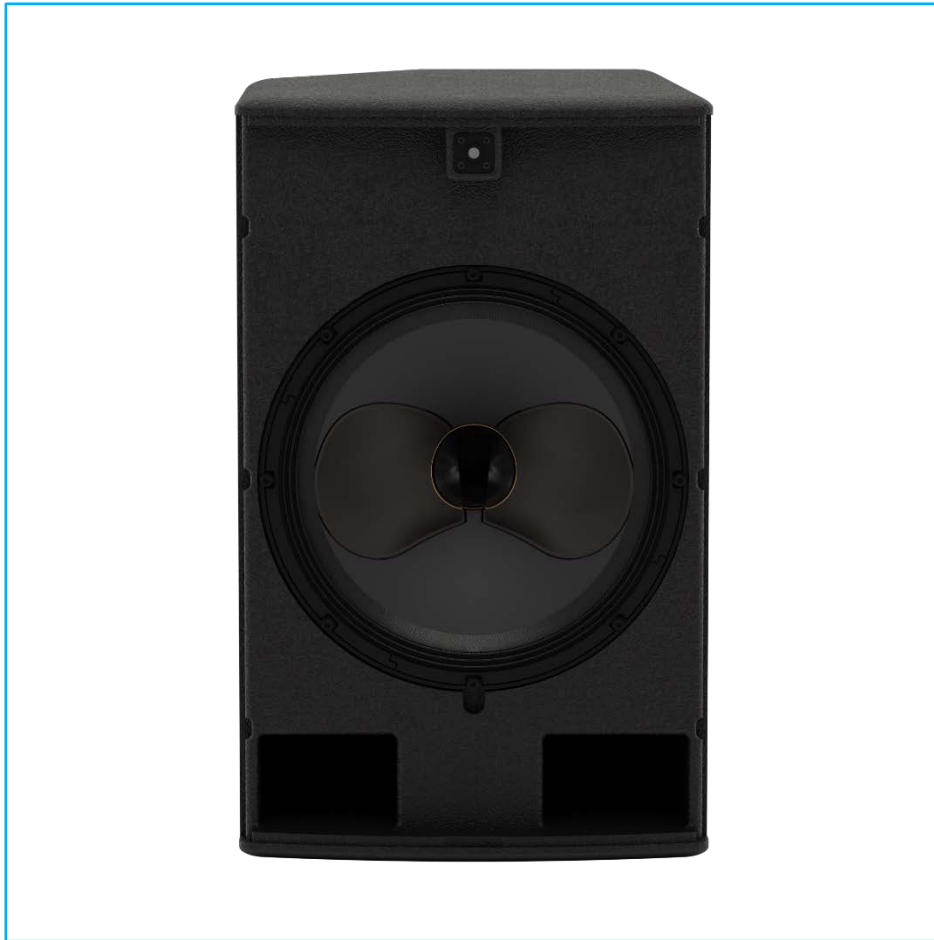

Ideal for medium-to-large rooms, the CDD-LIVE 15 is a very high-power, self-powered two-way system designed for professional live applications and installations that demand the ultimate in sonic performance from a single enclosure. It combines very high output capability with exceptional fidelity and coverage consistency. Its Coaxial Differential Dispersion driver comprises a powerful 15" (380mm)/3" (75mm) voice coil LF driver and a 1.4" (35mm) exit HF compression driver with a 3" (75mm) pure titanium diaphragm. Its fan-cooled Class D amplifier delivers 2000W LF + 500W HF peak output to the drivers and on-board DSP and Dante networking enhances system performance, flexibility and control.

CDD-Live 15 Accessories

- ASF20048 Universal Bracket Assembly
- CDDLIA15B Yoke Assembly
- ASF20071 Wind-up distance pole (for use in conjunction with the SXP218)
- ASF20045 35mm Stand Adaptor (for use with the Universal Bracket)
- HTK00003 8mm Shouldered Eye Bolt
- CDDLTC15 CDD-LIVE 15 Transit Cover

SXP118



The CSXP118 (Formerly CSX-Live118) is a compact, high performance subwoofer that extends the low frequency operating range of the combined system to 35Hz and provides exceptional low frequency impact. An ideal partner for the CDD-LIVE 8 and 12, it features a long excursion 18" (460mm)/4" (100 mm) voice coil driver with a water-resistant cone and triple roll surround in a compact reflex enclosure. The design of the 18" driver maximises output while minimising power compression and distortion, and the four reflex ports have a large frontal area to reduce turbulent air noise at very high levels. The enclosure is constructed from multi-laminate birch ply, finished with a durable polyurethane coating and equipped with a steel grille, twin grab handles, skids, flying inserts and a threaded pole socket. A twin-fan Class D power module delivers 2000W peak output to the driver, and crossover, EQ, and control functions are provided by the on-board DSP section.

SXP118 Accessories

- ASF20071 Wind-up distance pole
- HTK00004 10mm Shouldered Eye Bolt
- CDDLTC118 SXP118 Transit Cover
- CDDLRK118/218 Rain Kit Upgrade
- WHEELS Set of four castors

SXP218



The SXP218 achieves the ultimate in subwoofer performance for the most demanding professional applications – delivering very high output levels and superb transient performance with minimal distortion. With an operating range of 35Hz- 150Hz \pm 3dB, it houses dual 18" long-excursion (460mm)/4" (100mm) voice coil drivers with water-resistant cones and triple roll surrounds.

The enclosure is constructed from multi-laminate birch ply and coated with hardwearing textured paint. Eight reflex ports provide a large frontal area to reduce turbulent air noise, and a perforated steel grille protects the drivers from damage with minimal obstruction of airflow. The enclosure is equipped with four grab handles, skids and flying inserts.

A twin-fan Class D power module delivers 4000W peak output to the drivers, while on-board DSP performs crossover, EQ and control functions.

SXP218 Accessories

- HTK00004 10mm Shouldered Eye Bolt
- ASF20071 Wind-up distance pole
- CDDLTC218 SXP218 Transit Cover
- CDDLK118/218 Rain Kit Upgrade
- WHEELS Set of four castors

Connections

The rear panel is virtually identical on all models in the range and features all connections required in addition to the preset selection button. Mins input is via a Neutrik PowerCon True1. There is a female 3-pin XLR for analogue audio input with a parallel connected male outlet to enable easy daisy-chaining of an audio feed between cabinets. There are two Ethernet ports which allow PC connection for both control using Martin Audio's View-Net platform and for digital audio networking using Dante.



Mains

The mains inlet is a Neutrik® PowerCon True1 socket and a mating connector is supplied with each CDD-Live and SXP speaker. The True 1 is the latest version of Neutrik's PowerCon range and is a small, light, rugged, inexpensive latching mains connector rated for use up to 240V at 16A. It is rated with a breaking capacity according to IEC60320 and VDE0625 meaning that it can be connected and disconnected without first turning off the power feed. This has the advantage of being very convenient but also makes a power switch unnecessary as it is easy to turn the speaker off by activating the latch and turning the connector anticlockwise which will disconnect the power whilst leaving the plug in place in the socket so it can be quickly rotated clockwise to restore the power connection when required.

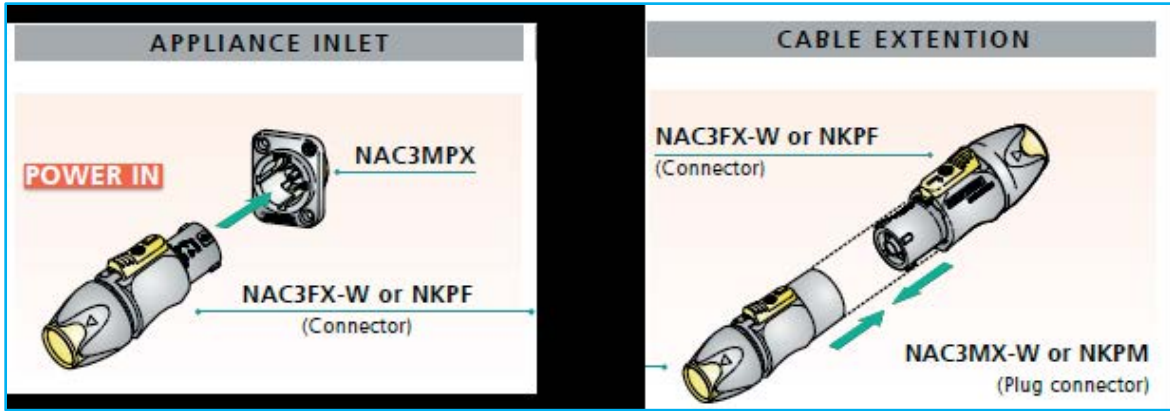

Wiring Instructions

Wiring instructions for the Neutrik® PowerCon True1 are as follows. Note that all mains wiring should be carried out by a competent, trained technician. If a suitable technician is not available Martin Audio would recommend purchasing one of the range of pre-made mains cables available as optional accessories. These feature the PowerCon True1 connector on a flexible cable of either 2.15m (part number ASF12024) or 5m (part number ASF12023) in length and are terminated in a 16A male Ceeform connector. Both cables are rated to IP67.

<p>Approval based:</p>	<p>VDE EN 60320</p>	<p>UL UL 498 / C22.2 No. 182.3</p>
<p>Rating:</p>	<p>250 V ac / 16A</p>	<p>250 V ac / 20 A</p>
<p>Cable Type:</p>	<p>H05VV-F3G 1.0mm², Length max. 2m H05VV-F3G 1.5 – 2.5mm² H07RN-F3G 1.5mm²</p>	<p>SJTOW, SJOOW 3 x 12 AWG</p>
<p>Strain Relief:</p>	<p>White Chuck</p>	<p>White Chuck</p>
<p>Cable O.D.:</p>	<p>6.0 – 12.0 mm</p>	<p>6.0 – 12.0 mm</p>
<p>A Prepare cable as shown</p>		

B Place chuck over the cable

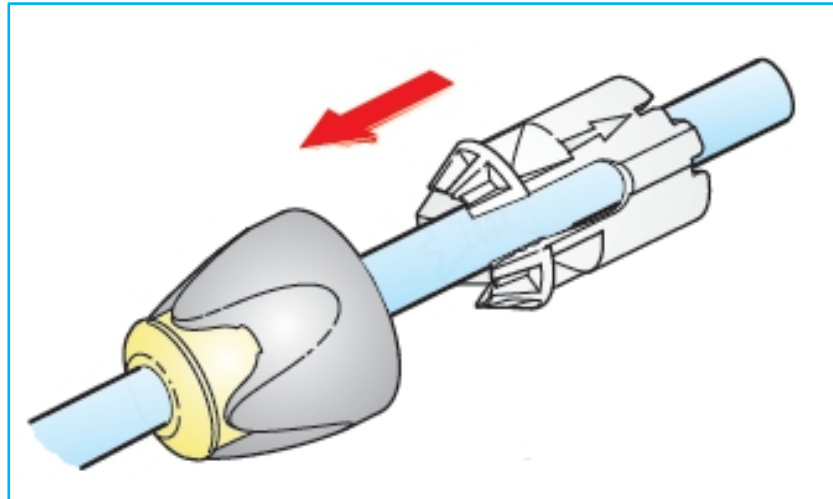





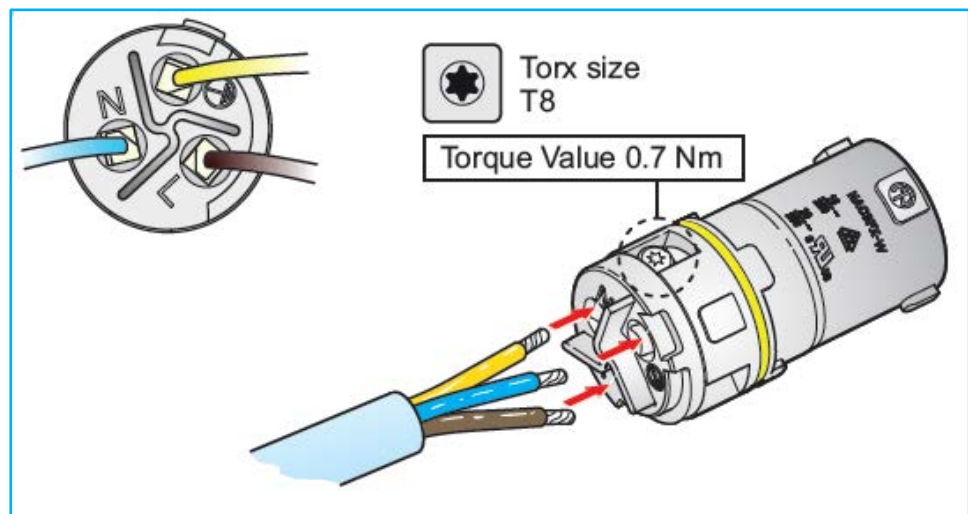

C Wire the connector

Using a Torx T8 driver, the fixing screws should be tightened to a torque value of 0.7 Nm



- Live ⇨
- Neutral ⇨
- Ground ⇨

	brown		black
	blue		white
	green/yellow		green

D Assemble the connector

Slide the chuck onto insert (1) and then both into the housing.

Note: Align the chuck by positioning the nose into the keyway.

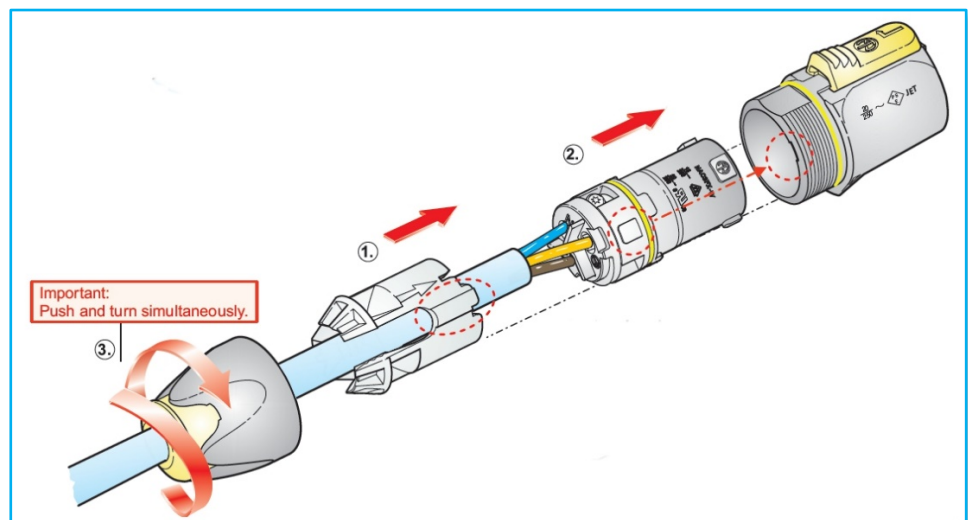

E Tighten the cable clamp

Slide the cable clamp up the cable and tighten. To wire the connector to IP65, the cable clamp needs to be tightened to a torque value of 2.0Nm using the Neutrik tool no. HTAC with a 13mm spanner.

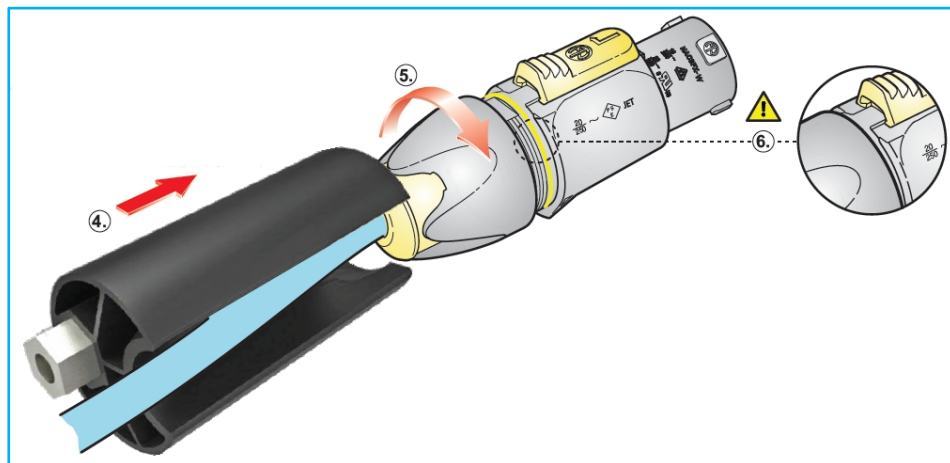

To Disassemble

Press a small flat-blade screwdriver into the cable clamp bush by the ▼ symbol, continue to push the screwdriver in whilst unscrewing the clamp.

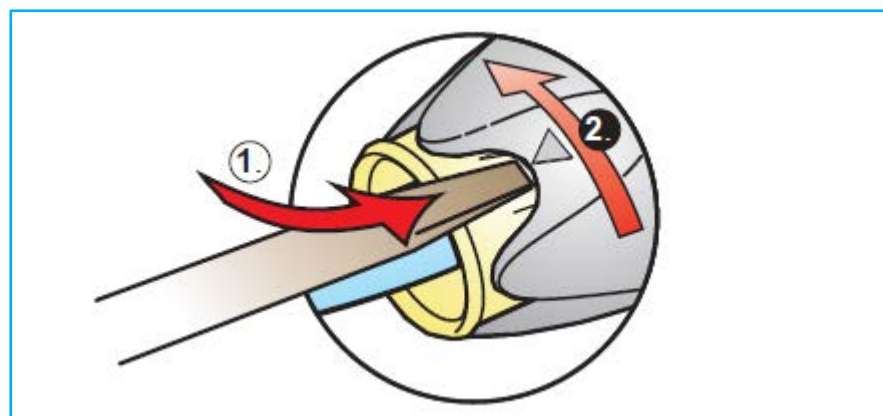

Audio

Analogue audio is available on a 3-pin XLR socket with a parallel male XLR socket to enable easy "daisy-chain" wiring looping from one speaker to the next. Analogue inputs should be connected with a good quality 3-pin male XLR wired to good quality twin screened cable. This is particularly important if the input cable run is long (e.g., from the FOH position to stage). Good quality cable will minimise losses. The Link outputs should use a similarly high quality female XLR. The line driver at the signal source must be able to drive the combined load of all DD12s being linked (See section 11). Wiring is the industry standard for balanced connections:

PIN	CONNECTION
1	Ground or shield
2	Signal 'hot' ('+')
3	Signal 'cold' ('-')

Ethernet

The two Ethernet ports are available on Neutrik Ethercon connectors which can be used either with a compatible mating connector (see list) or directly with a CAT5 cable with RJ45 connectors. The connections are routed to a two-port switch which enables daisy-chain Ethernet/Dante connections of up to 8 cabinets. Alternatively, a star network configuration can be adopted using any Gigabit enabled Ethernet router connecting individual Ethernet Cables to each cabinet. Note that the ports can carry both Dante and TCP/IP data simultaneously so a Dante network can be set up with control over all CDD-Live and SXP cabinets via Vu-Net.



Note that you must use a network system that includes a DHCP server to connect multiple CDD-Live and SXP products, a simple Ethernet switch will NOT work unless the entire system is configured for Static IP, you will need an Ethernet router or a device connected to an Ethernet switch which will support DHCP to assign IP addresses to all devices on the network.

You can connect directly from a PC Ethernet port to ONE CDD-Live or SXP cabinet which will self-assign an IP address in the same range as the PC- this takes around 1 minute and after that it will be possible to connect to the cabinet via Vu-Net (see the chapter on Vu-Net for more details).

You CANNOT daisy chain more CDD-Live and SXP cabinets in this configuration, it can only be used with a single cabinet so its use is limited to simple checks or firmware updates.

Dante is realised using the Audinate Ultimo board, this does not support Primary and Secondary connections, but redundancy is possible using an analogue audio feed simultaneously with a Dante network. The input will automatically select Dante if a signal is present however it will automatically switch to the analogue feed if the Dante signal is lost.

The Ethernet ports have standard LED indicators to show operation. The Green LEDs show that the port is operational and should illuminate as soon as a connection is made to or from an Ethernet port from any other port. The yellow LEDs flash to show data speed. The Dante LED will illuminate when a Dante feed is present.

Preset Operation

All systems in the CDD Live and SXP speakers have a preset option for quick plug-and-play operation. The preset switch is on the connector panel on the back of the cabinets. Pressing the switch cycles through the presets circling back to preset 1 after preset 4. The selected preset is indicated by the corresponding Preset LED.



CDD-LIVE 8, CDD-LIVE 12, CDD-LIVE 15

All full range systems in the CDD-Live range have four presets as follows; -

Preset 1



Full range operation for a pole or stand-mounted configuration

Preset 2

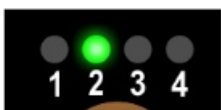

High-pass mode when used in partnership with either of the SXP subwoofers.

Preset 3

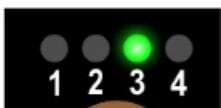

Full range operation in stage monitor mode. The driver must be rotated 90°, see the chapter on grill removal and driver rotation.

Preset 4



User-preset. This enables a frequently used configuration to be programmed via Vu-Net and stored for future use without the need to connect a PC; Perhaps a venue that is attended regularly for a specific application.



SXP118, SXP218

The four presets for the SXP subwoofers are as follows, the LED indication is slightly different to reflect the cardioid modes; -

Preset 1

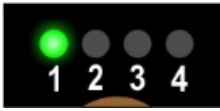

Sub used in conjunction with the CDD-Live12 or 15

Preset 2

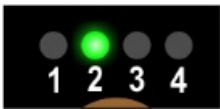

Sub used in conjunction with the CDD-Live 8

Preset 3

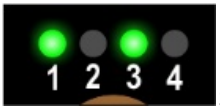

Sub used with the CDD-Live 12 or 15 in Cardioid mode (rear facing)

Preset 4

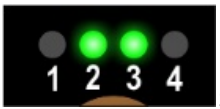

Sub used with the CDD-Live 8 in Cardioid mode (rear facing)

Note that the selected preset is retained after powering down the CDD or SXP speaker. The same preset will still be selected when you next power-up the cabinet.

Note that when a system is connected to Vu-Net via the Ethernet ports the preset LEDs will be extinguished to show that the system settings may have been changed. To restore the preset once Vu-Net is disconnected press the preset button until it has cycled round to the preset you require, any changes made in Vu-Net will be overwritten with the factory setting.

Meter Mode

An additional feature is Meter mode which is selected by pressing and holding the Preset select button for two seconds. In this mode the LEDs which normally indicate which preset has been selected, become an input level bargraph to show level applied to the speaker. To return to normal Preset selection, press and hold again for two seconds.

CDD LIVE8, 12 & 15 Cabinet Configuration

The CDD-Live range is designed to be used in one of three modes, "portrait" or upright either on a speaker stand, distance pole, wall bracket (CDD-Live 8 and CDD-Live 12), yoke or flown using the Universal bracket in conjunction with a scaffold clamp, or flown using shouldered eye bolts. They can be used in "landscape" mode horizontally using a yoke or universal bracket or eye bolts, and finally as a stage monitor using the multi-angle cabinet shape. All products are supplied by default in portrait mode, when used horizontally either flown or as a stage monitor it is vital to rotate the CDD driver to maintain the correct dispersion for your application.

Grill Removal

Grilles on CDD-LIVE! Series cabinets are designed to be easy to remove to facilitate driver rotation. No screws are used to hold them in place; they are manufactured with a natural spring which holds them in place in slots in each side of the cabinets. The grilles have two or three gaps in the sides depending on the model into which an appropriately sized flat-bladed screwdriver can be inserted to assist in removal.

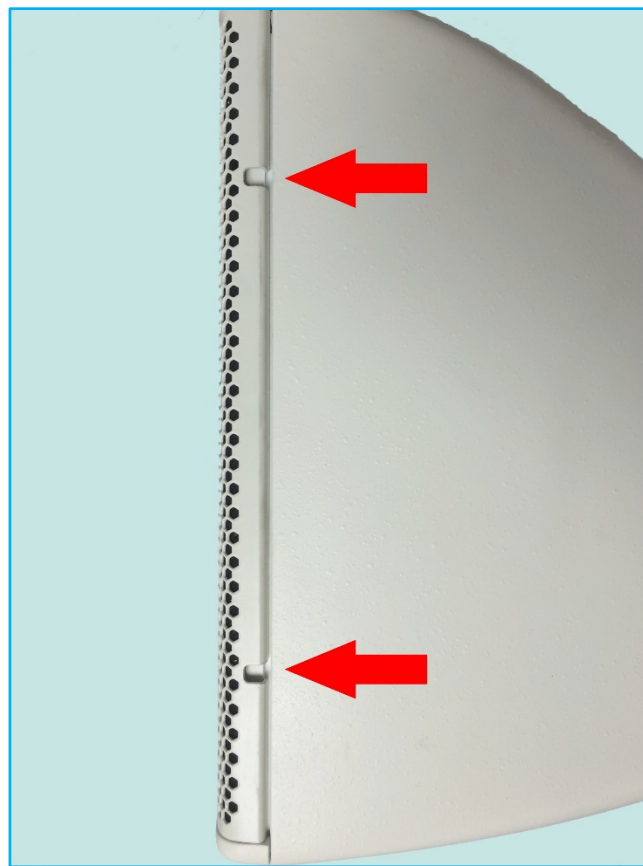

Insert the screwdriver blade into one of the gaps - either at the top or bottom of the cabinet (don't start in the middle).



Push the handle down a little first. This will ease the grille out of the slot.

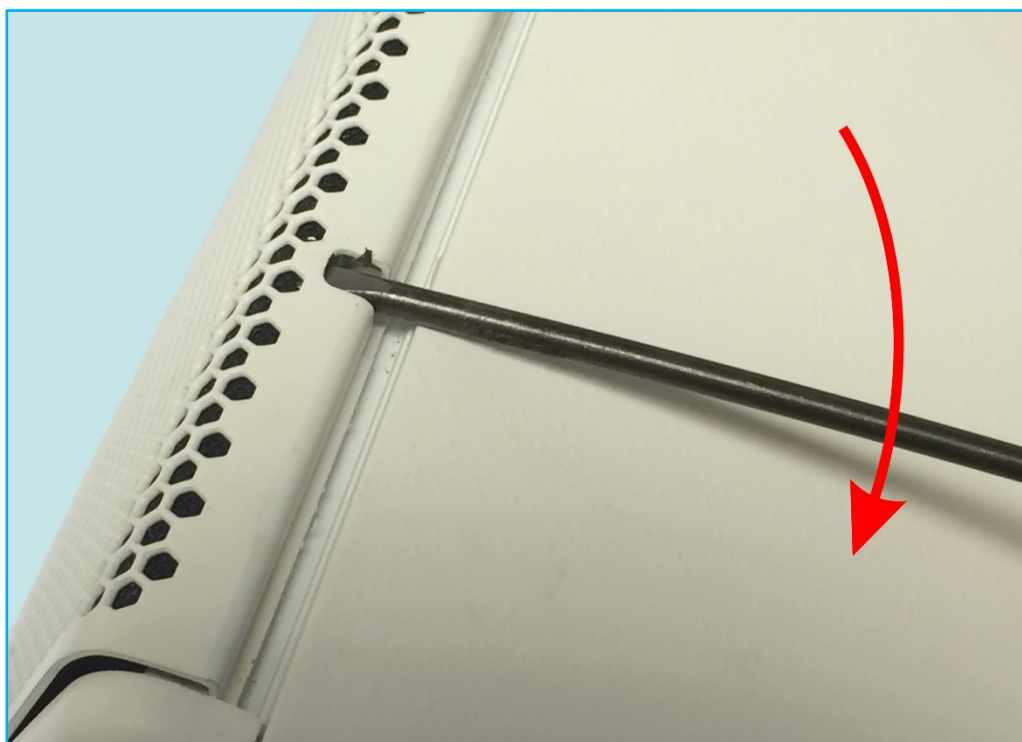

Now lift the handle up; this will ease the grille forward slightly to prevent the return on the grill dropping straight back into the slot:

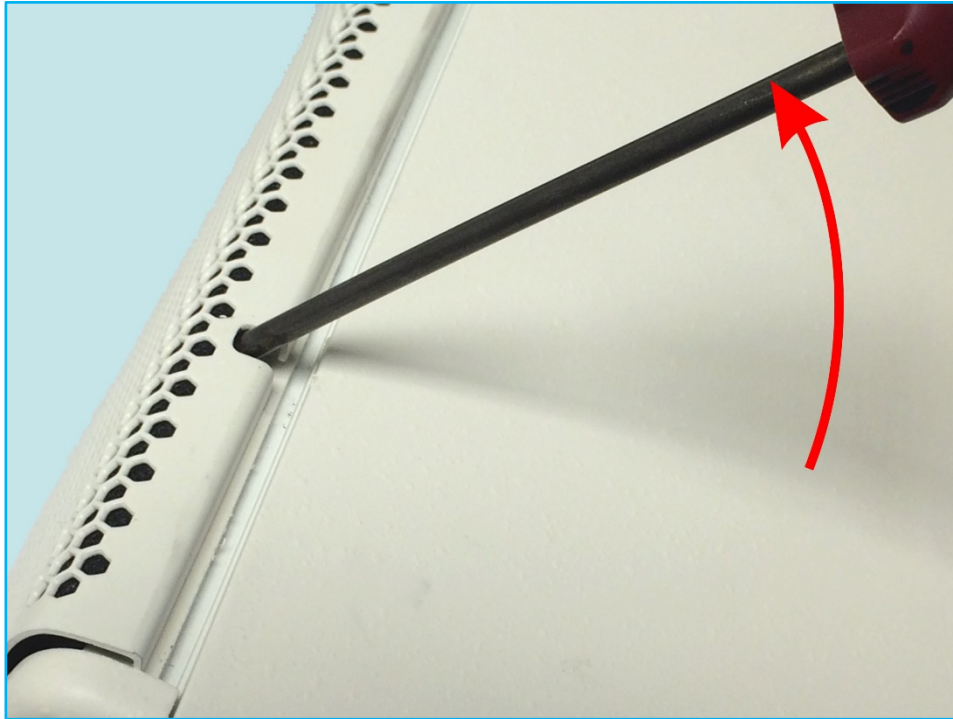

Repeat this process for the remaining gaps in the grille to ease it out of the slot all the way up one side of the cabinet; when you get to the final gap the grill should pop out and away from the front of the cabinet.

To replace the grille, first insert one side into the slot on one side of the cabinet. Make sure the return on the grille is completely engaged in the slot. Push on the front of the grille with the flat of your hand, which will encourage the other edge of the grille to locate on the side of the cabinet close to the slot. Now push the edge of the grille back starting at the top or the bottom to engage the return in the slot; you may need to do this a little at a time, working down the length of the grille until it pops into place.

Badge Rotation

The badge can also easily be rotated to match the orientation of the cabinet. The fixing point is spring loaded, so it is simply a case of pulling the badge slightly forward and rotating it to the required position.

Rotating Driver

With the grille removed the driver mounting screws are accessible. There are four screws for the CDD-Live 8 and four for the CDD-Live 12 and eight for the CDD-Live 15. The screws are hex head, the Hex key sizes are as follows; -

- CDD-Live 8 5mm
- CDD-Live 12 5mm
- CDD-Live 15 6mm

Fully unscrew all mounting screws, the driver can be carefully raised using a small flat-blade screwdriver inserted into the recess at the bottom of the cabinet



Be careful not to push the screwdriver in too far which could easily damage the cone suspension. Lever the driver up enough to get your fingers under the edges of the driver. Lift it up just enough to get a firm grip, do not put any strain on the connecting wires. Rotate the driver through 90° either clockwise or anticlockwise depending on your application. Check that the driver is at the correct orientations as shown below; -

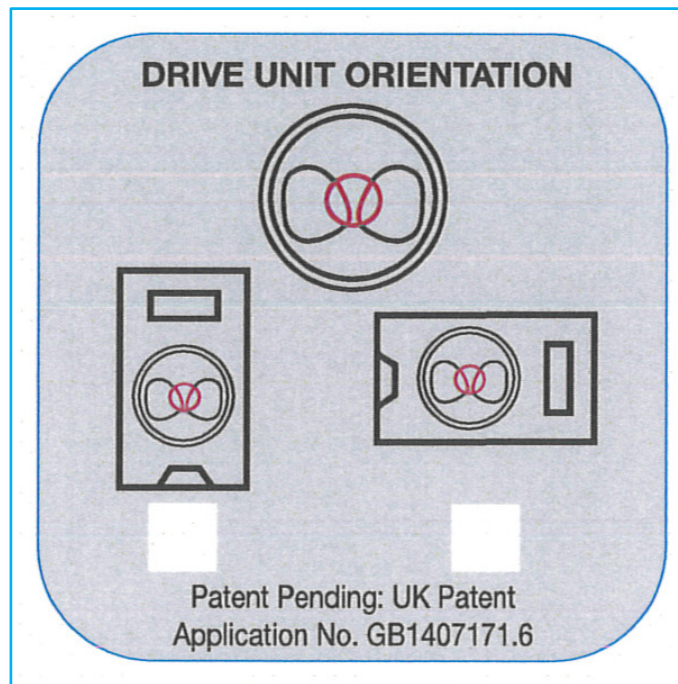

Re-fit all driver mounting screws tightly, rotate the badge as mentioned above and replace the grille as previously described.



Dante

Based on industry standards, Audinate Ltd created Dante, an uncompressed, multi-channel digital media networking technology, with near-zero latency and synchronization. Dante is the preferred audio networking solution that has been adopted by more pro-audio AV manufacturers than any other networking technology. Interoperability is not a dream of the future, but a reality today. Hundreds of Dante-enabled products are available from the world's leading manufacturers, enabling you to mix devices from multiple manufacturers.

One cable does it all. Dante does away with heavy, expensive analogue or multicore cabling, replacing it with low-cost, readily available CAT5e, CAT6, or fibre optic cable for a simple, lightweight, and economical solution. Dante integrates media and control for your entire system over a single, standard IP network.

Dante systems can easily scale from a simple pairing of a console to a computer, to large capacity networks running thousands of audio channels. Because Dante uses logical routes instead of physical point-to-point connections, the network can be expanded and reconfigured at any time with just a few mouse clicks.

Since audio is transmitted digitally, you don't have to worry about the common analogue challenges of interference from other electrical equipment, crosstalk between cables, or signal degradation over long cable runs.

Setting up Dante networks couldn't be easier. You no longer have to shudder when considering the deployment of an audio network. Even the most complex networks can be set up and configured quickly and easily with Dante, making system integration simple. Dante automatically handles the technical complexities for you.

Signal routing and system configuration with Dante is fast, simple, and incredibly flexible. Dante Controller is a powerful software application that manages devices on the network. Setting up a Dante network is typically just a matter of plugging devices into an Ethernet switch and connecting a computer to the network. All Dante devices are automatically discovered and displayed in Dante Controller, so you can be up and running in seconds.

With Dante Controller you can easily edit device names and channel labels, control sample rates, and set device latencies. There is no longer any need to remember device IDs or channel numbers. Instead, a single audio channel is referred to just like an email address: "leadVocal @ StageBoxSL or "chairmans_mic @ conferenceroomA". Set it and forget it. Once the network is configured, the computer running Dante Controller can be removed from the network and reconnected only if changes are required or system monitoring is desired. Signal routing and other system settings are stored safely in the Dante devices themselves, so they are automatically restored if a device is power-cycled.

Real-time information about the health of your network is essential for a proper understanding of its performance. Audinate has developed a rich suite of diagnostic tools within Dante Controller, providing visibility into the network health status through features such as device latency monitoring, active clock health monitoring, packet error reporting, and bandwidth usage statistics.

Dante Controller

Dante Controller software can be downloaded from the Audinate website; -

<https://www.audinate.com/products/software/dante-controller>

Devices are connected together on a single network and the software will find and identify all Dante enabled devices present. They are presented on a very straightforward Matrix with all Dante transmitters such as digital mixing consoles and system processors on one axis and Dante receiver- such as the CDD-Live and SXP range- on the other. Routing transmitters to any or all of the receivers is a simple click on the appropriate node or nodes on the matrix.

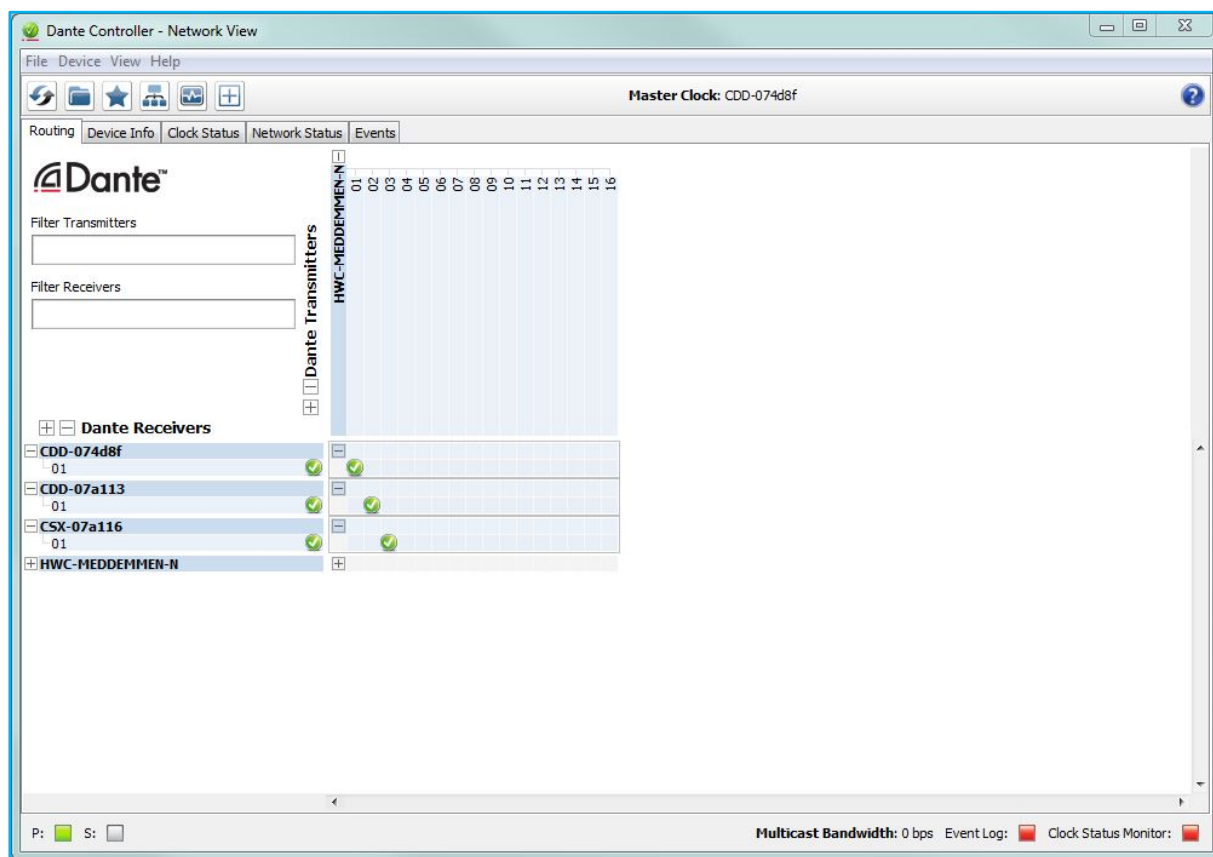

For more details visit the Audinate website which has a host of support material including demo and tutorial videos, an FAQ page and PDF User Guides.

System Wiring Examples

With such a versatile system it is impossible to demonstrate every possibly wiring configuration but we will show examples of a variety of different systems to show how the options can be used to integrate the CDD-Live and SXP range with the requirements for a huge number of system designs.

1. Basic System

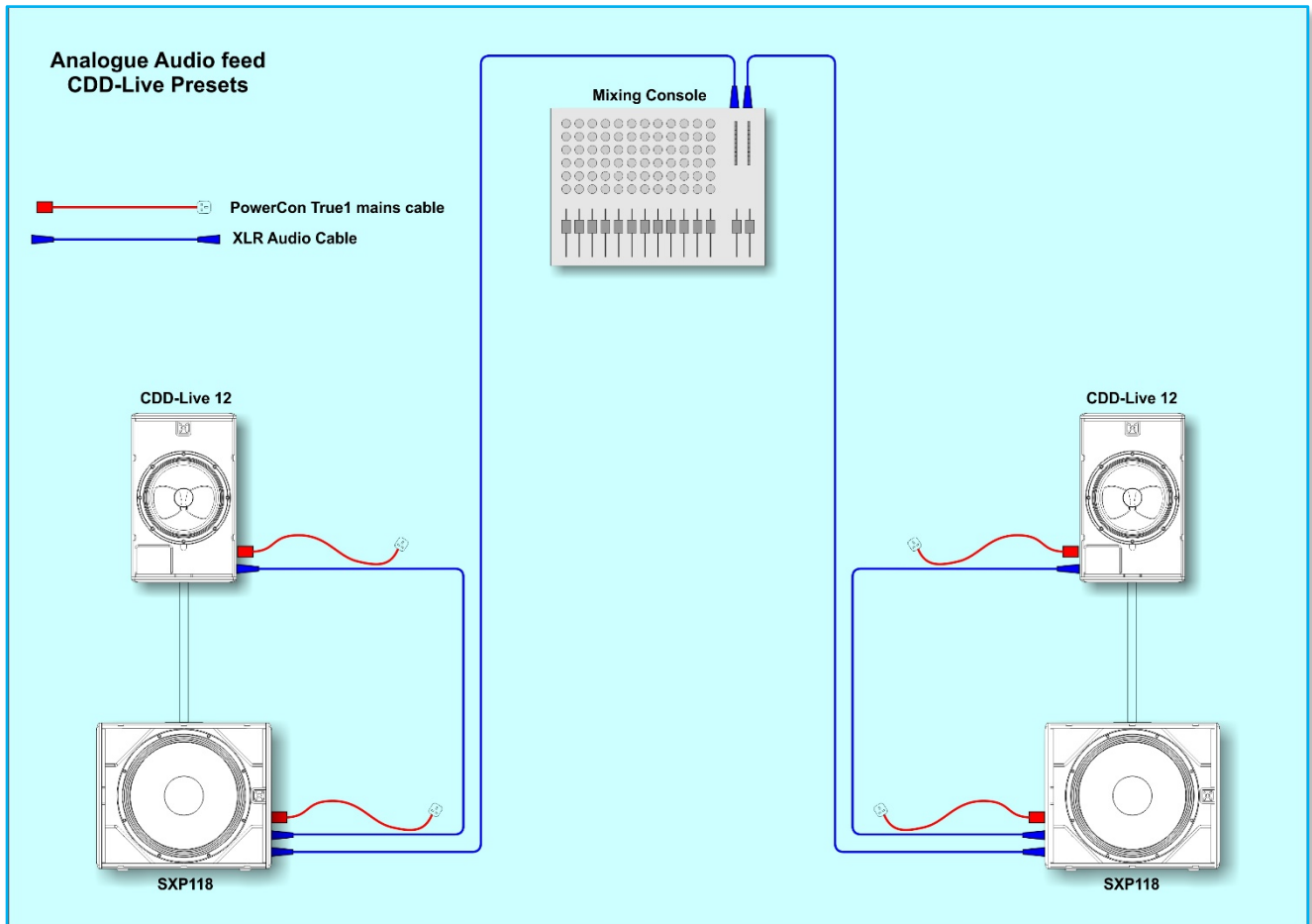

This illustrates the simplest deployment of a stereo CDD-Live system. Analogue Audio from your source is routed to left and right, it is connected to the SXP118 subs, the parallel out is used to link up to the CDD-Live 12s. In this example Preset 1 would be selected on the SXP118 and Preset 2 on the CDD-Live 12. All crossover and equalisation processing is taken care of by the internal DSP using the selected presets.

2. System with Vu-Net Control

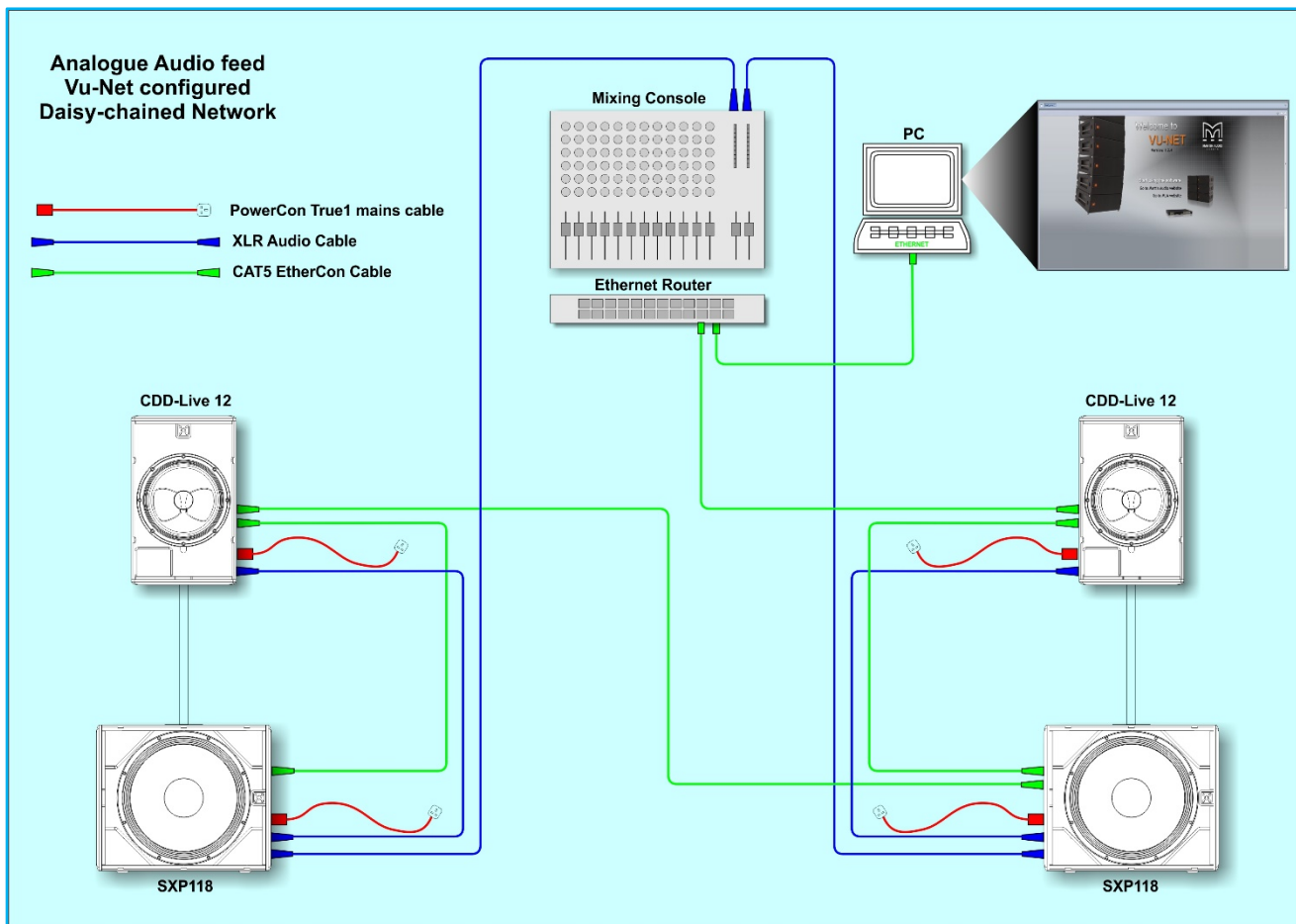

With this system the audio feed remains exactly as with the basic system sending a stereo analogue audio feed to the cabinets. Control over the system has been enhanced by adding a network.

An Ethernet feed from a PC running Martin Audio's Vu-Net connects to an Ethernet router (Note that the router must include a DHCP Server unless the entire system is configured for Static IP) with a feed from a second port on the router to the first of the CDD-Live cabinets and the on-board 2-port Ethernet switch is used to daisy-chain between all cabinets to extend the network (maximum 8 speakers). Note that if the router and your PC are wi-fi equipped you can connect to the system over wi-fi making the Cat 5 cable from the PC to the router unnecessary and giving you the freedom to walk the room to make any fine adjustments to the system using Vu-Net.

With Vu-Net you now have a high level of control over the system, you can mute, adjust gain, delay and equalisation and also have the option of storing the settings to the user memory location which can be recalled in future using the rear panel switch. If for example you are using the system in a venue that you visit regularly, you can store the settings making it unnecessary to connect the network and PC at subsequent visits.

Be aware that the preset LEDs on the back of each CDD-Live and SXP cabinet will be off due to the Vu-Net connection, you should however see the Ethernet LEDs illuminated, the green will show a good network connection and the yellow LED will flash to show communication speed.

3. System with Audio via Dante

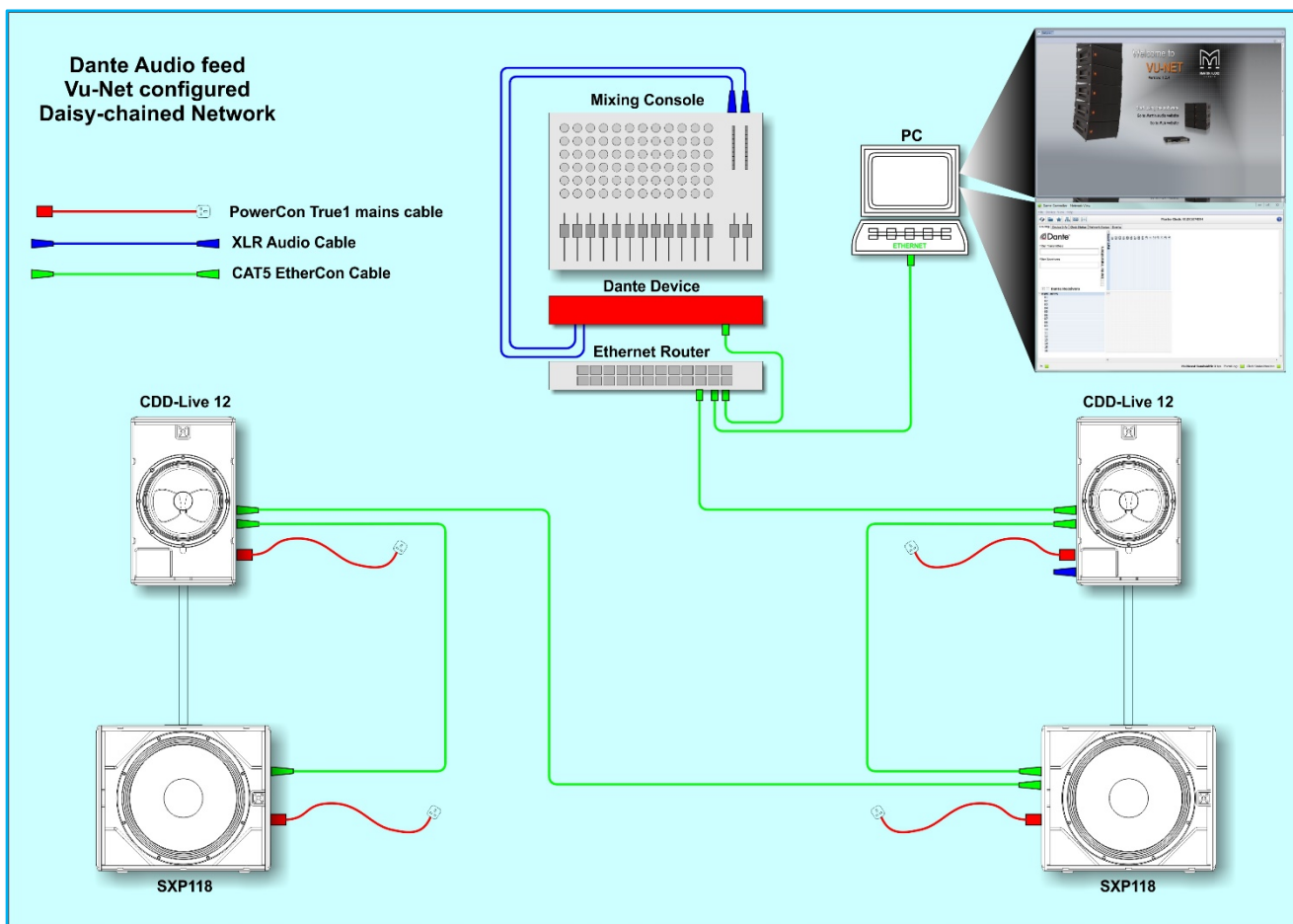

This system demonstrates the simplest implementation of Dante. The analogue audio connections to each cabinet are no longer required, a Dante feed is derived from your audio source using one of the hundreds of Dante enabled devices. The diagram shows an analogue mixing console routed to a Dante interface such as a DX4.0 or one of the Focusrite RedNet range however this could be a digital mixing console, a great many of which have Dante outputs either as standard or as an option.

The Dante feed is routed to an Ethernet router (Note that the router must include a DHCP Server unless the entire system is configured for Static IP) along with an Ethernet feed from the PC and an Ethernet cable out to the first CDD-Live speaker. As before the Ethernet connections are daisy-chained between all speakers using the 2-port interface in each CDD-Live and SXP speaker to a maximum of 8 speakers.

The PC can run Dante Controller and Vu-Net simultaneously to control both the Dante routing and all DSP parameters. Once the Dante routing is taken care of and any adjustment of the CDD-Live and SXP speakers is completed in Vu-Net the PC can be disconnected and all routing and speaker parameters will be stored, even after disconnecting and reconnecting power. Once again you can remotely control the system if the router is Wi-Fi equipped, this includes controlling the Dante routing as Dante Controller will work over Wi-Fi. What will not travel over Wi-Fi however is Dante audio so if you were for example using your PC as a source for walk-in music and were using Dante Virtual Sound Card, the connection to the network must be hard-wired.

Be aware that the preset LEDs on the back of each CDD-Live and SXP cabinet will be off due to the Vu-Net connection, you should however see the Ethernet LEDs illuminated, the green will show a good network connection and the yellow LED will flash to show communication speed.

4. Network Control with Star Configuration

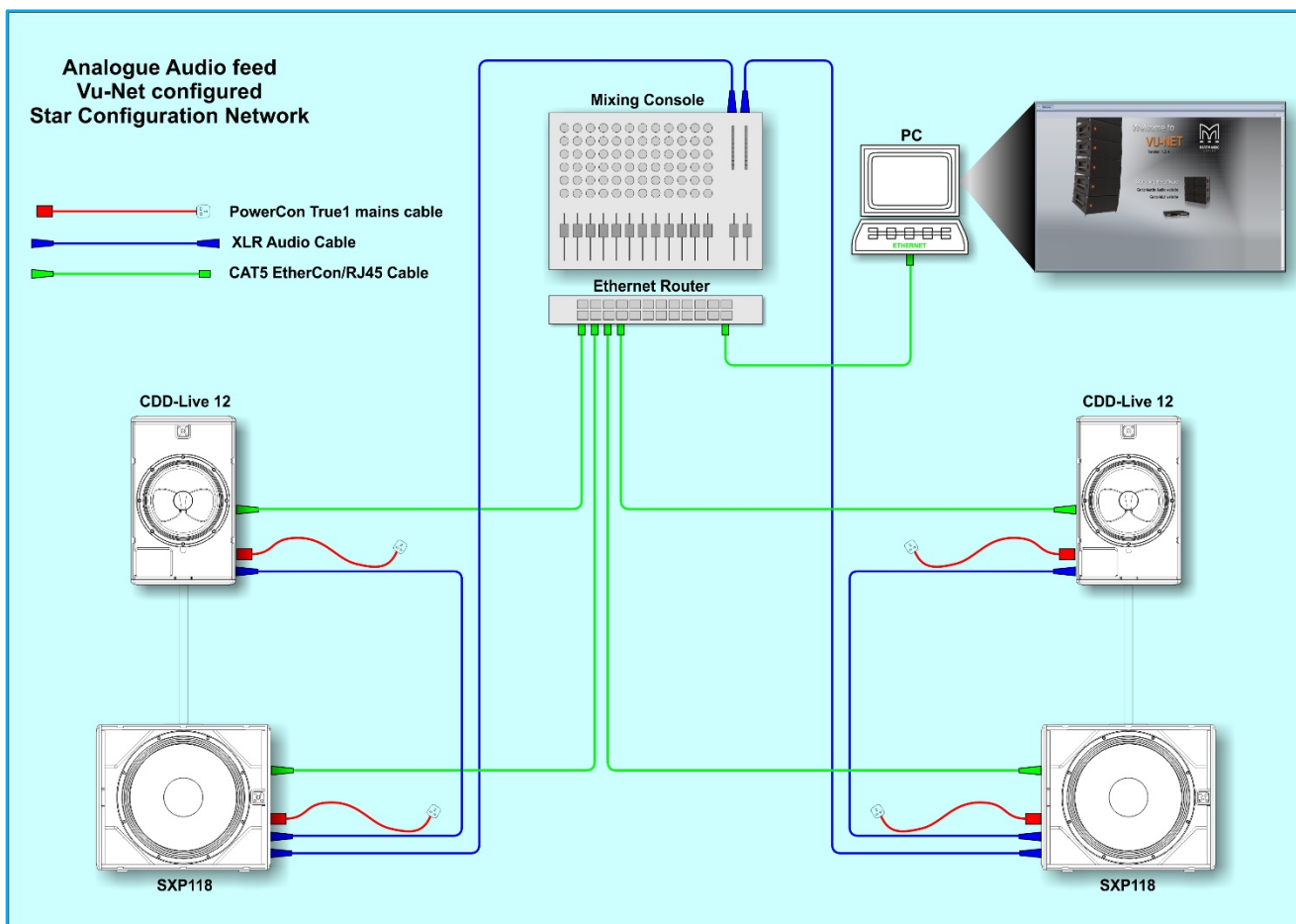

As with our example number two, analogue audio is routed to our left and right speakers and we can control the parameters in depth using Vu-Net, in this example however, the network connection to each cabinet is made with an individual Ethernet cable from an Ethernet router (note that the router must include a DHCP server unless the entire system is configured for Static IP).

This may be a more convenient wiring solution particularly for a fixed installation and would have to be used if more than eight speakers from the CDD-Live and SXP range are in use as that is the maximum recommended for a daisy-chain configuration. You can however run a system with mixed star configuration and daisy-chained cabinets, any of the cabinets routed directly to the Ethernet switch can have up to seven cabinets daisy-chained from their second Ethernet port making huge systems possible.

Be aware that the preset LEDs on the back of each CDD-Live and SXP cabinet will be off due to the Vu-Net connection, you should however see the Ethernet LEDs illuminated, the green will show a good network connection and the yellow LED will flash to show communication speed.

5. Dante Control with Star Configuration

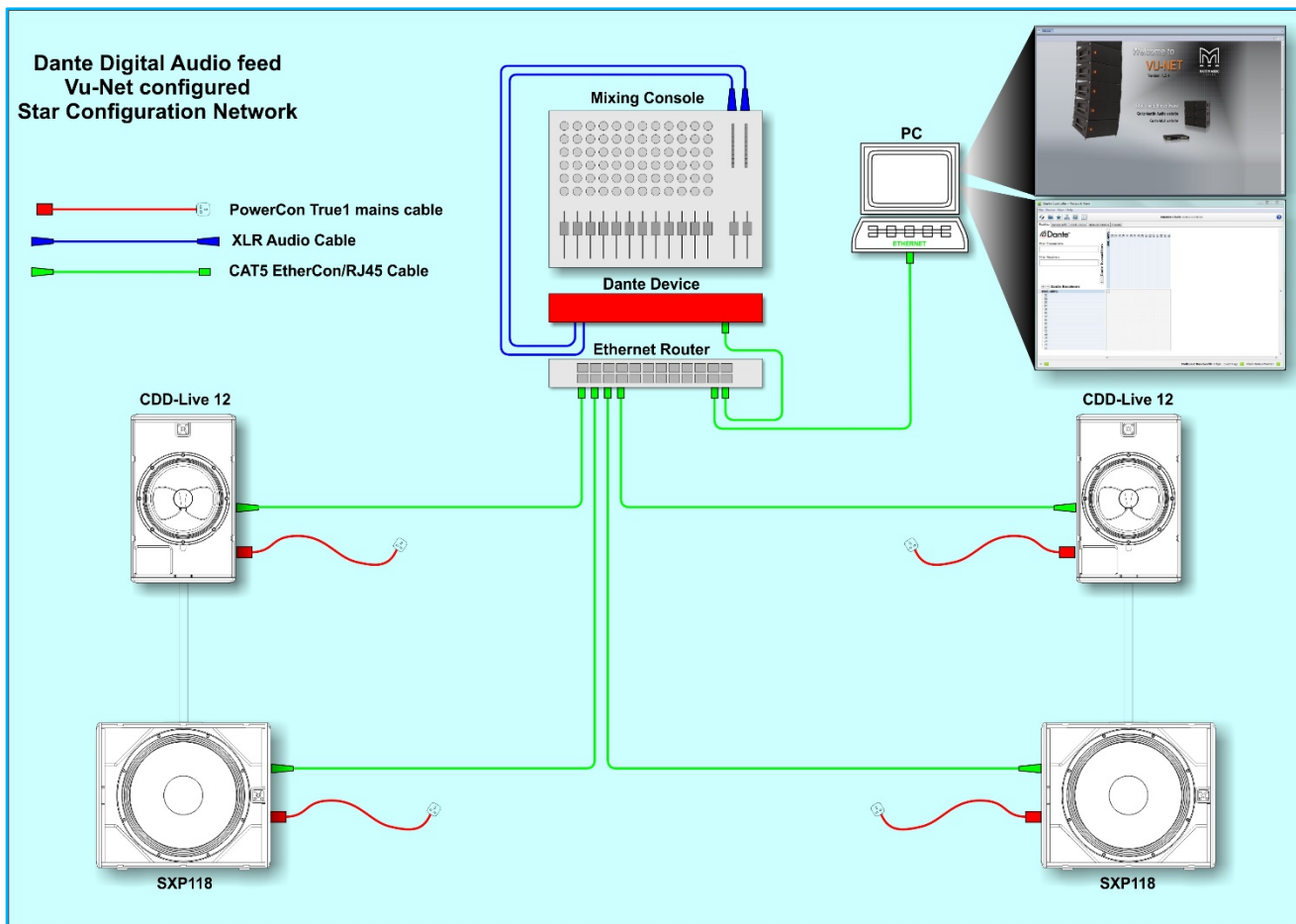

With this system the audio is again derived from a Dante Source and routed to an Ethernet router as with example 3. The control PC is connected to the same router and runs Dante Controller to route the digital signal from the source to the CDD-Live and SXP cabinets as required over the Ethernet network. In this case however in similar fashion to example 4 the Ethernet connection to each CDD-Live and SXP speaker is made individually to a separate port on the Ethernet router (note that the router must include a DHCP server unless the entire system is configured for Static IP).

As with example 4 this wiring configuration may be preferred particularly for installed systems. It has the advantage over a daisy chained system in that should power fail to a single cabinet it will not have any effect on the remaining CDD-Live and SXP speakers in the system.

Be aware that the preset LEDs on the back of each CDD-Live and SXP cabinet will be off due to the Vu-Net connection, you should however see the Ethernet LEDs illuminated, the green will show a good network connection and the yellow LED will flash to show communication speed.

6. Integrating with an MLA System

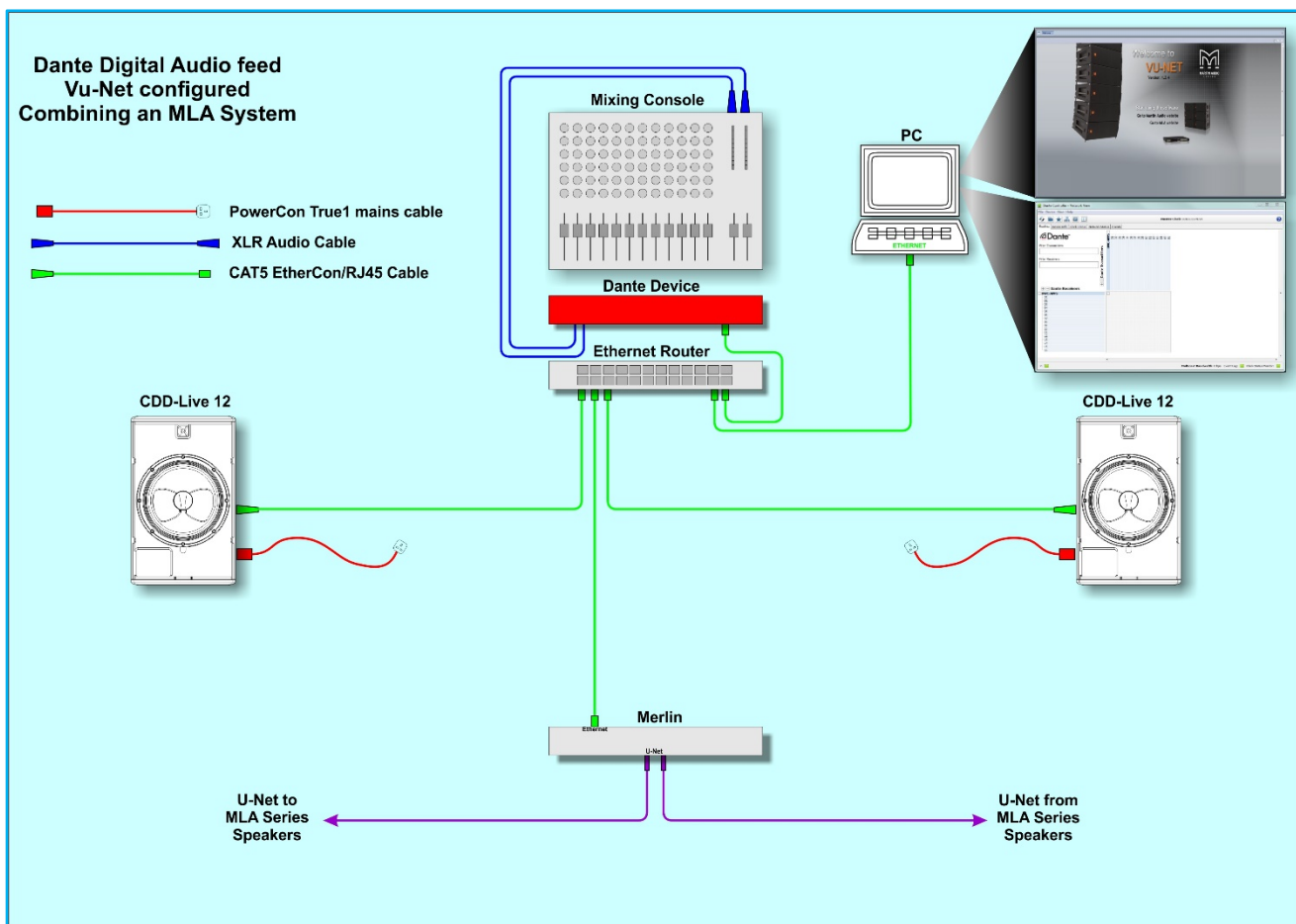

CDD-Live is ideally suited to being integrated with a Martin Audio Multicellular system, the entire system can be managed via a single Vu-Net project.

Connection to an MLA System is via the Merlin System controllers which are connected over Ethernet so it is very straightforward to make the connection via a single Ethernet router which can include the Package switch supplied in an MLA Master rack. An Ethernet Connection is fed out to all CDD-Live cabinets either individually or daisy chaining up to eight speakers

Ethernet from the PC to the switch can be wired or wireless if remote configuration is required. This can be the Ruckus Wi-Fi system and Tablet PC supplied with an MLA or MLA Compact system, or your own wi-fi infrastructure in an installed system as long as the network supports DHCP.

An MLA Mini system can be connected either directly to the PC via a USB cable to one of the MSX Subs or also via a Merlin Controller making use of the U-Net ports on the MSX. The Merlin must be configured for Dynamic IP unless the entire system has been configured for Static IP.

An all cases, when running Device Discovery in Vu-Net all devices will be found regardless of the connection method employed.

7. MLA Mini with additional SXP218 subwoofers

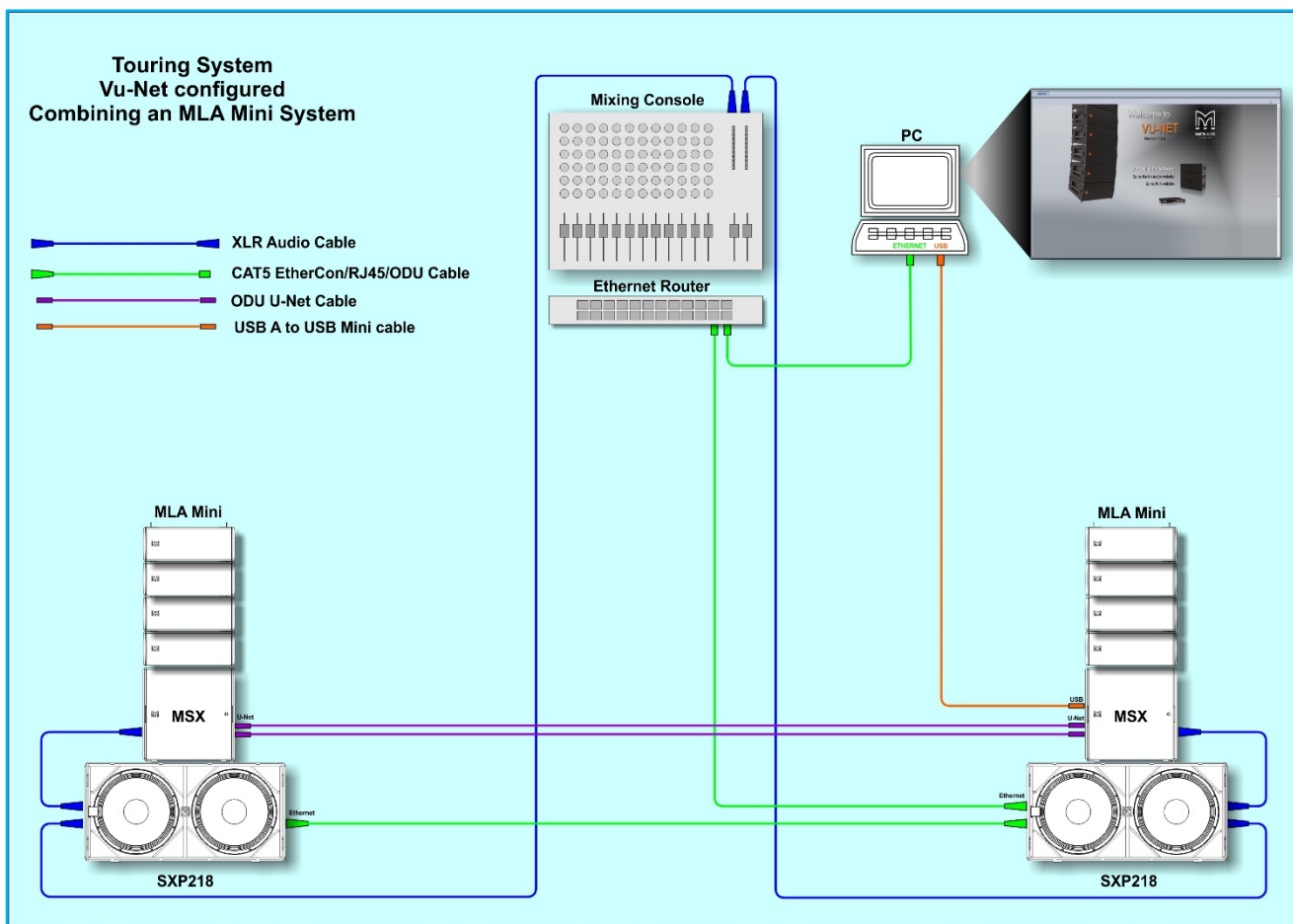

As mentioned in option 6, CDD-Live and SXP speakers can easily be integrated with MLA Mini systems. A practical example might be to use a pair of SXP218 subwoofers to extend the low frequency response of an MLA Mini system in larger venues. The MLA Mini system is set up in the usual manner with a USB connection from the PC to the first MSX and a pair of U-Net cables link the two MSX creating a closed loop to provide redundancy.

An Ethernet connection runs from the same PC to an Ethernet router (note that the router must include a DHCP Server unless the entire system is configured for Static IP) and then to the first SXP218 subwoofer and daisy-chains over to the second sub using Ethernet Port 2 on the sub.

Analogue Audio is fed from the mixing console to left and right, connecting first to the SXP218 then using the parallel out to link to the input on the MSX Sub.

Vu-Net is run on the PC to control the system, Device Discovery will find the two MLA Mini arrays and the two SXP218's, these can all be configured for the optimum parameters for a combined system, all from a single PC platform.

The only minor drawback with the configuration above is that you would not be able to configure the system for AES/EBU digital. One option is to connect directly from a digital AES source to the MSX's and then route Dante digital to the SXP218s over the network cables already in place.

8. MLA Compact Combined with SXP218

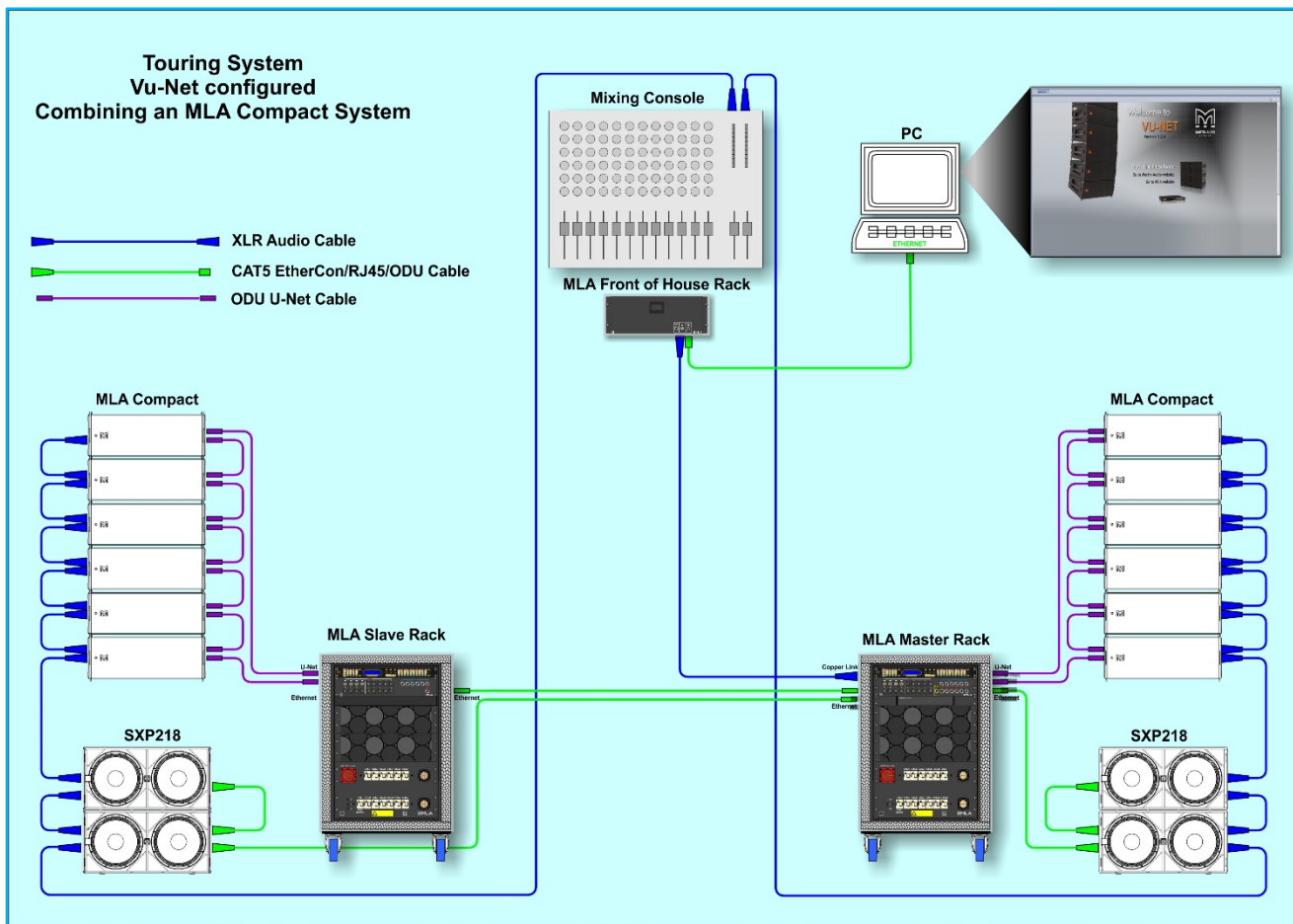

In this example the SXP218 subs have been deployed with an MLA Compact system as a lower cost alternative to the DSX or MLX subwoofer. Much of the infrastructure is based around the standard MLA compact system components.

Analogue audio is routed from the mixing console to left and right first connected to the SXP218 Subs linking between each sub using the parallel output XLR before linking up to the MLA Compact array and using short XLR links between each MLA Compact Cabinet. It would of course be perfectly acceptable to send an independent sub feed from the console which is a common practice.

A Master and Slave rack are used for U-Net connection to all MLA Compact cabinets. The advantage of an MLA Master Rack is that it features an Ethernet Switch used to network the Merlin Processors in all racks and the same switch can be used to link the SXP218 subs. The MLA rack patch panels bring the Ethernet connection out on the rugged and IP68 rated ODU connectors. One ODU Cable is required to link Ethernet between the two racks. Some adaptor cables are required to go from the ODU connectors to the EtherCon connections on the SXP218s. The diagram shows two such cables one going to the left sub array and one to the right. It would however be perfectly reasonable to use a single adaptor to the right array and then use EtherCon to EtherCon cables to link the SXP218 on one side before using a long EtherCon cable to cross the stage to the left array with a further link cable to join the two subs on that side. This is a perfectly acceptable solution for up to 8 subwoofers, the limit of the network daisy-chain configuration. For larger sub arrays use one ODU to EtherCon for each side of the system giving you a maximum of 16 subs in total, 8 subs per side which is likely to be plenty for all but the very largest venues.

PC Connection to the Master rack is either by WiFi or using the MLA Front of house rack which enables the Ethernet Copper Link system allowing Ethernet runs of hundreds of metres over twisted pair cable using standard 3-pin XLR cables, commonly a free line on a returns multicore can be used.

As with other examples, Device Discovery in Vu-Net will find all SXP subwoofers and MLA Compact allowing complete system control and monitoring from a single platform on a tablet PC.

Vu-Net

Vu-Net is Martin Audio's proprietary application for control of monitoring of network controlled powered products. Introduced as the control platform for the award-winning Multicellular products MLA, MLA Compact and MLA Mini, a number of products have been added to Martin Audios portfolio that can be incorporated into a single project and configured using Vu-Net. CDD-Live and SXP are incorporated into the application allowing control of a system which may comprise of a combination of products from several ranges on a single platform.

Basic operation is reasonably straightforward however it is beyond the scope of this User Guide to explain the finer points of the software so for full operation guidelines please download the Vu-Net User guide from www.martin-audio.com/software. You can also download the application from this location.

Introduction

Vu-Net is the application used to connect to a U-Net enabled device such as the multicellular family of products, Wavefront Precision via the IKON amplifiers, the DD12, PSX, CDD-Live, SXP Subwoofers, Merlin, DX4.0 or U-Hub processors. Connection to the cabinets is achieved either using the U-Net network protocol, USB in the case of the MLA Mini, DD12 and PSX and Ethernet for the CDD-Live, SXP and IKON ranges. Vu-Net is used to monitor and control the system, EQ optimisations for multicellular arrays are uploaded from the program and cabinet firmware is checked and updated.

Before running Vu-Net you need to make sure that all CDD-Live and SXP cabinets have been connected to an Ethernet network using one of the options shown in the System Wiring examples. Once this has been completed, you can run Vu-Net.

When Vu-Net opens you will see the following Window; -



This is a blank screen with only 'New Project' and 'Open Project' active prompting you to start by using one or the other. Start by clicking on 'New Vu-Net project. You will see the following window; -

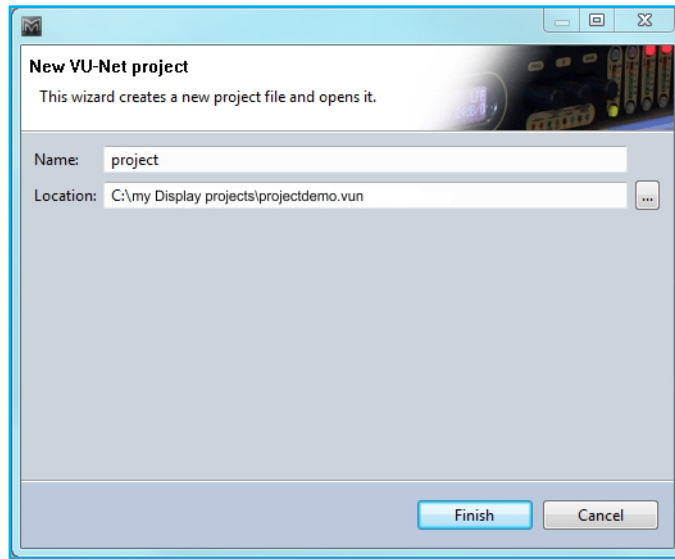

Type a name for your project and select a suitable file location.

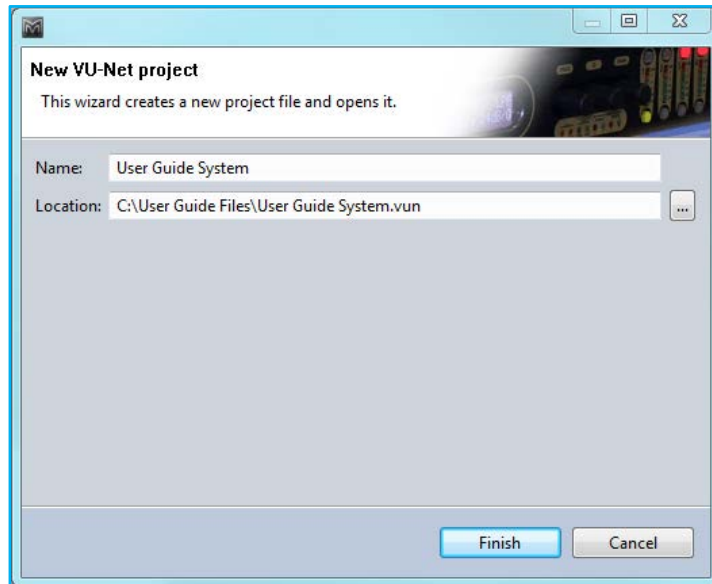

Once you have selected an appropriate name and file location click finish and a new project will be created; -



You will notice that the top left of the main window has your project name and a number of options on the toolbar are now available.

Device Discovery

The normal method for operating a system following completing the system rigging and connection is to open Vu-Net and to run Device Discovery. It is good practice to check your network connectivity, first by using the network icon on the PC task bar which should show connection to your system (it will flag that there is no internet connectivity which can be ignored). If all is ok you can proceed by clicking on the Discover Devices button;-

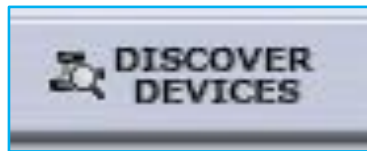

Assuming everything is OK with your network connection you will see the following window; -

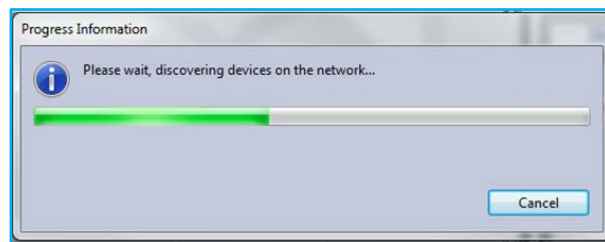

The meter bar will gradually move across until it is completely green and all devices have been found. This may take a few seconds on bigger systems with many cabinets.

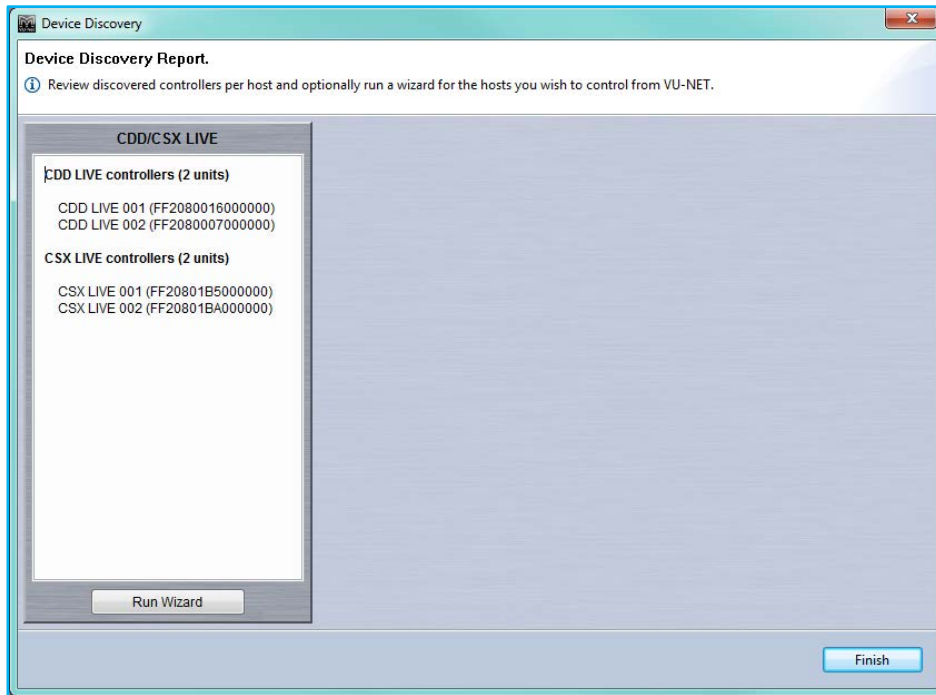

There are no array configuration options so clicking on 'Run Wizard' simply synchronises the cabinets with Vu-Net so that what is displayed in the application is exactly the configuration of the connected cabinets; -

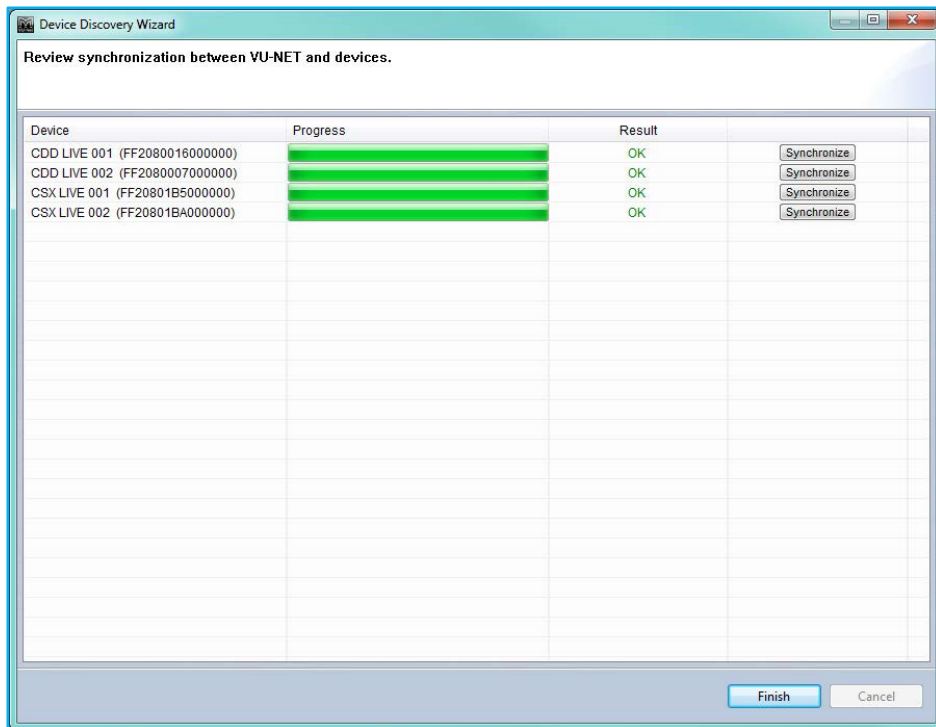

Once discovered the range will appear in Vu-Net like this; -

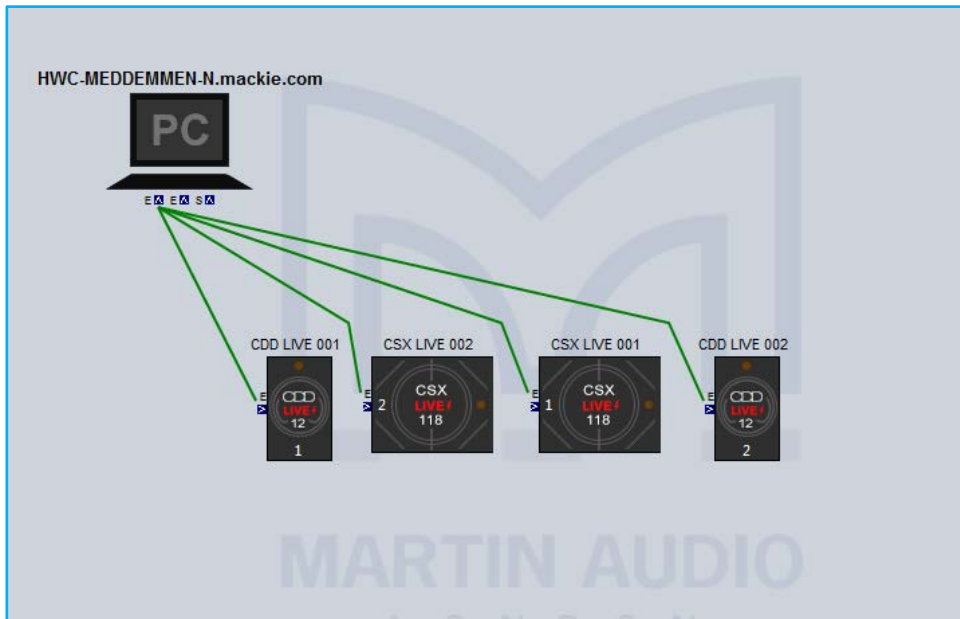

Each CDD-Live device will be shown as an icon which includes the front grille LED. If you click on the cabinet to select it you can then click on the LED which will illuminate on the icon and on the speaker to make it easy to identify which cabinets you re controlling, useful particularly when you are arranging the overview screen in Vu-Net to represent the physical positioning of the system;-



Right clicking on any of the speakers brings up a number of menu options; -

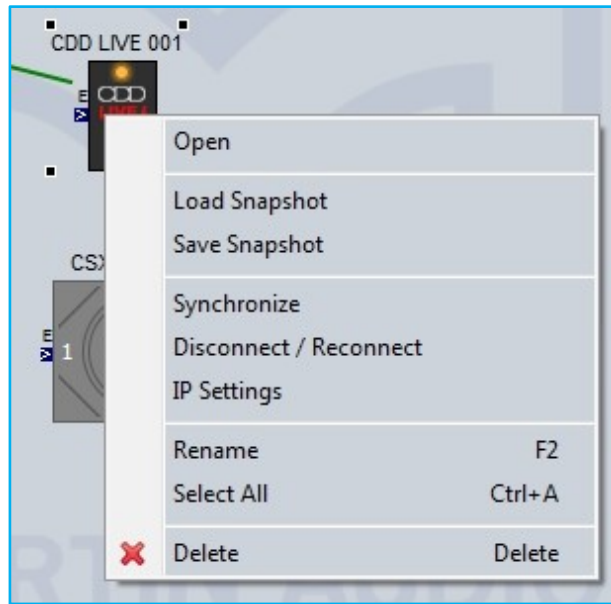

'Open' has exactly the same function as double clicking on the speaker icon to open the full control window.

'Load Snapshot' opens the Snapshot window allowing you to recall any of the three Factory Snapshots or the fourth User Snapshot;-



'Save Snapshot' is the function used to store parameters that you have edited to the User Location "U". This location can be recalled using the Load Snapshot command or by selecting Snapshot 4 using the button on the speaker connector panel. To store a Snapshot once you have made all the parameter changes that you need, select 'Save Snapshot', you will see this window;-

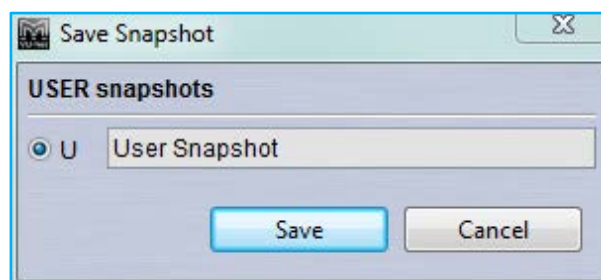

Click 'Save' and your setting are now stored and can be recalled when required.

'Import Snapshot' allows you to import a snapshot previously stored as a file on your PC. Selecting this option will open the following Window;-

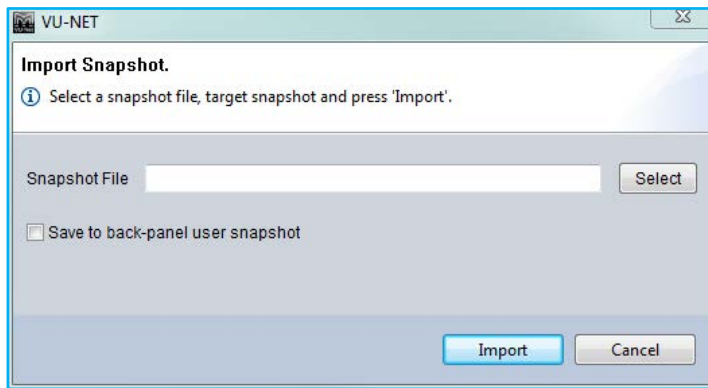

Click on the 'Select' button to navigate to the location on your PC where your CDD-Live files are located. If you would like to store the imported snapshot directly to the User Snapshot location so it can be stored and selected in future without a PC connected click on the 'Save to back-panel user snapshot' box. If this is left un-checked the snapshot settings will be imported but will be lost when a new snapshot is selected from the rear panel switch.

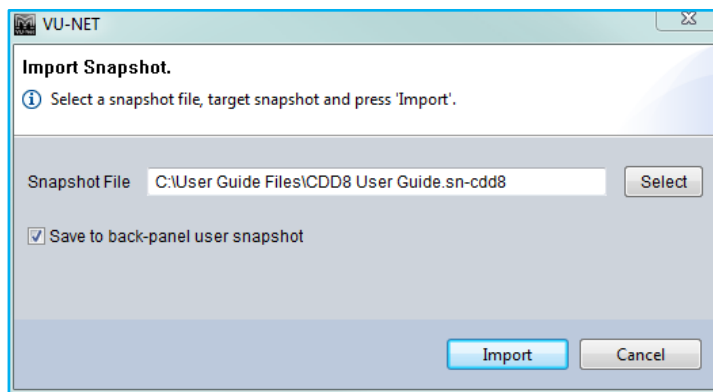

Click 'Import' and the snapshot is downloaded from your PC to the CDD-Live DSP.

'Export Snapshot' is used to store CDD-Live settings as a file to your PC. This can be used to archive snapshots to build a library of commonly used settings which can be quickly imported back into a system. This is the Export Snapshot Window; -

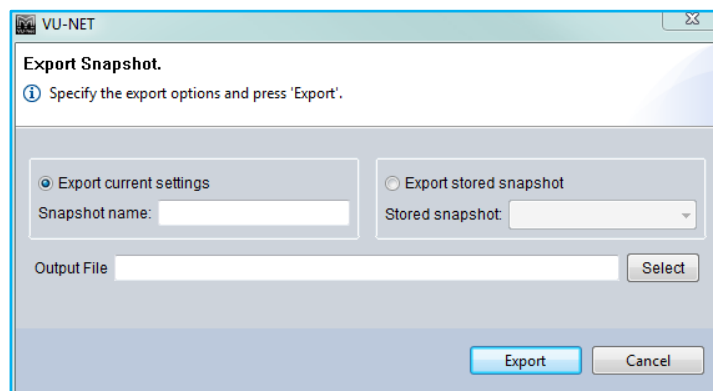



You can choose to select the current active settings, a true snapshot of the system configuration, or to export one of the four Snapshots stored in the cabinet DSP. If you choose to Export the current settings, you should first give the Snapshot a name so it is easy to identify when it is imported back into a cabinet "CDD-Live8 Stereophonics" for example.

If you click on 'Export stored snapshot' you next need to select one of the four internal snapshots, either 1 to 3 which are the factory snapshots or 4 which is the user snapshot location.

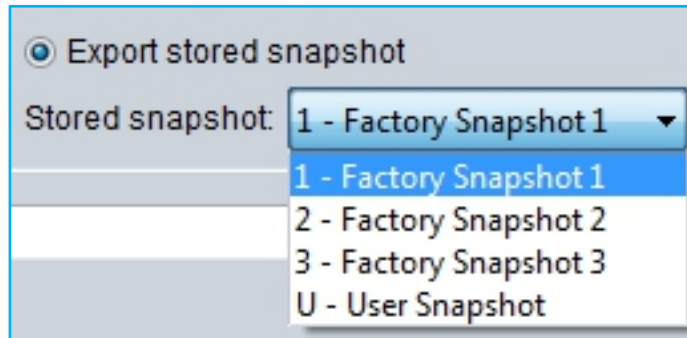

Next click 'Select' to navigate to an appropriate location on your PC to store the file and give it a suitable name.

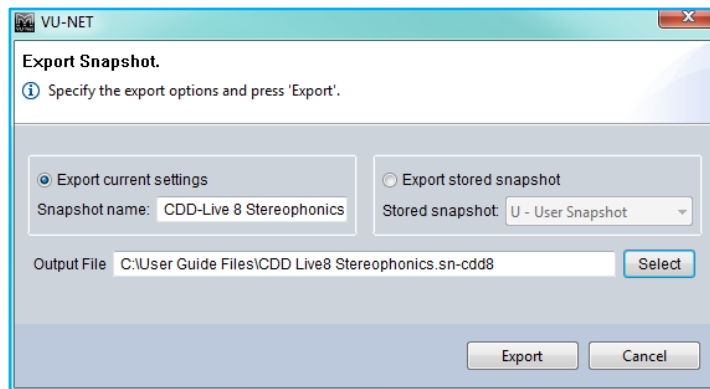

Finally click 'Export' to upload the Snapshot to your PC.

'Synchronise' is a manual synchronise that duplicates the automatic synchronise that occurs when CDD-Live is discovered to ensure that what is displayed in Vu-Net matches exactly the parameters stored within the cabinet DSP.

'Disconnect/Reconnect' allows you to disconnect and individual cabinet which will turn red once disconnected; -

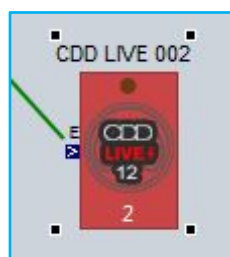

Selecting the same function will reconnect the cabinet and it will revert to the standard appearance.

'IP Settings' allows you to change from the default Dynamic IP to static. Clicking on the option brings up this window; -

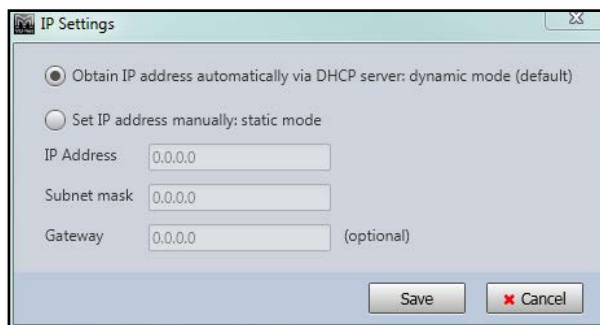

If you select Static IP you will need to enter a manual IP address and subnet mask in the same range as all other devices on the network that you need to communicate with. If you click on 'Set IP address manually: static mode', the IP address, Subnet mask and Gateway windows previously greyed-out will become available; -

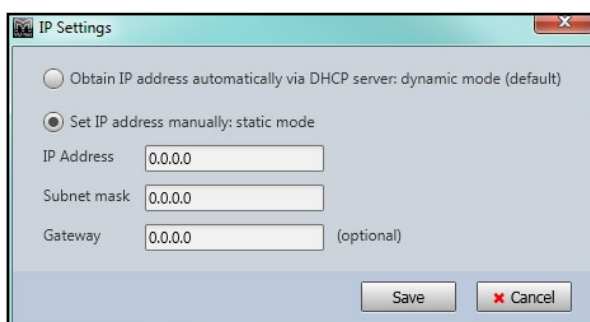

Enter the IP address that you wish to set the CDD-LIVE or SXP product to.

Subnet mask is usually set to 255.255.255.0, which means that this CDD-LIVE or SXP can communicate with any other product on the same subnet, which has the same IP address in the first three parts xxx.xxx.xxx.

The gateway refers to a device used as a bridge between a LAN and all other IP addresses, usually on a separate LAN which has its own router (hence DHCP server). If communication is required with devices outside of the primary LAN the default gateway needs to be set, usually to the IP address of the second router. For networks with all CDD-LIVE and SXP speakers and the PC on the same LAN this can be left at 0.0.0.0.

Click 'Save' and then power-cycle the cabinet, which will set its IP address to the static value entered in the dialogue box shown above.

Once this is done you will no longer be able to see the CDD-LIVE or SXP speaker in Vu-Net because Vu-Net is still running on a network with dynamically assigned IP addresses. You will need to close Vu-Net and set your PC to a static IP address in the same subnet as the CDD-LIVE product before you can connect to the CDD-Live product again.

'Rename' allows you to give the cabinet a name of your choice up to 30 characters, this can also be accessed by selecting the speaker and using the keyboard shortcut F2;-

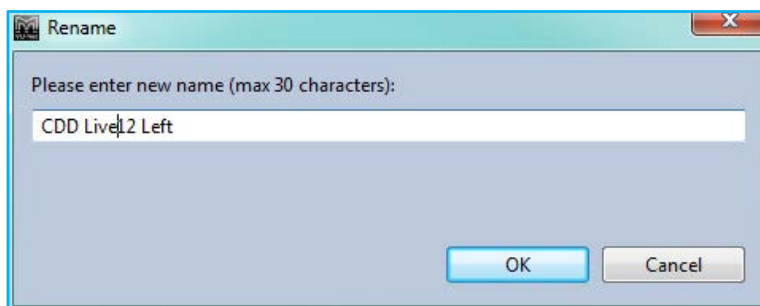

'Select All' selects all devices in the system Diagram, the keyboard shortcut for this is Ctrl + A.



'Delete' removes the selected CDD-Live speaker. You will be prompted with the following Window to confirm the delete;-

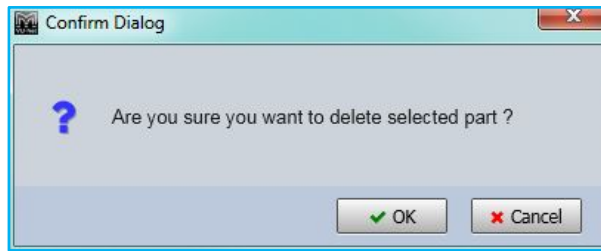

If you selected Delete accidentally or have changed your mind, click 'Cancel', otherwise click 'OK' and the speaker will be removed from the project.

Overview

Either double clicking or right clicking and selecting Open will bring up the overview option for the CDD-Live which shows all CDD-Live speakers in the project, a separate overview shows all SXP subs;-

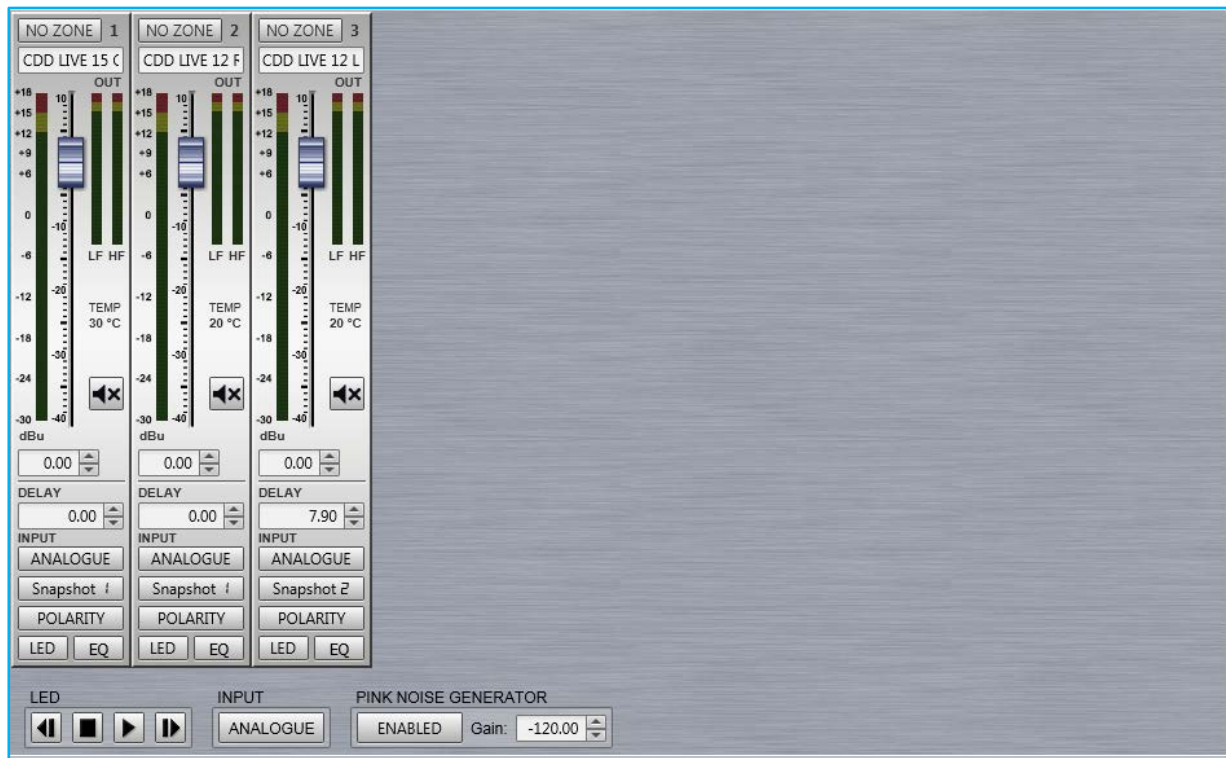

This is the SXP Overview: -

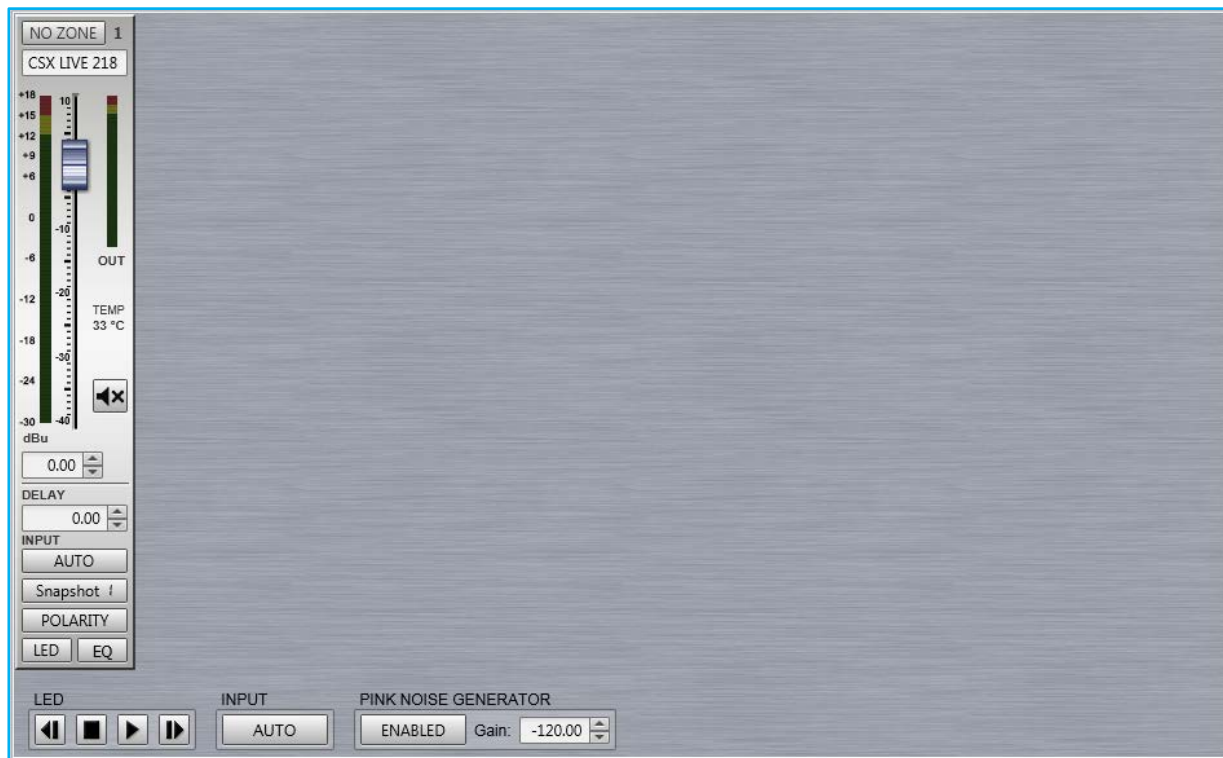

This gives an overview of the state of all CDD-Live and SXP speakers allowing comprehensive monitoring of the system.

The box at the top will show any names that have been assigned to the cabinets by right clicking and selecting rename (or selecting and pressing F2 in the System Diagram;-

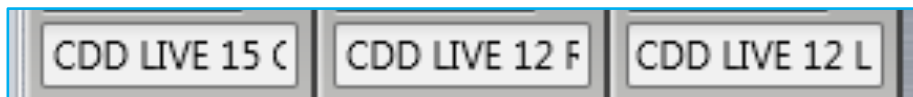

The gain fader allows gain adjustment from -40 to +15dB. Precise values can be entered by typing directly in the box below the fader or values can be scrolled up or down using the up/down buttons. The increments that the up/down buttons will step is determined in the Preferences section, by default it will be 0.25dB.

The mute button will mute the cabinet irrespective of the position of the gain fader and will turn red when active.

There is comprehensive metering available. The bargraph to the left of the fader shows input level up to the maximum before input clip of +18dBu. The smaller meters to the right show the amplifier output levels for both the low frequency amplifier driving the LF driver and the high frequency amplifier driving the compression driver and show level prior to limit. If the levels reach the yellow segment you have reached the limiter threshold. A red segment indicated 3dB of gain reduction in the limiter.

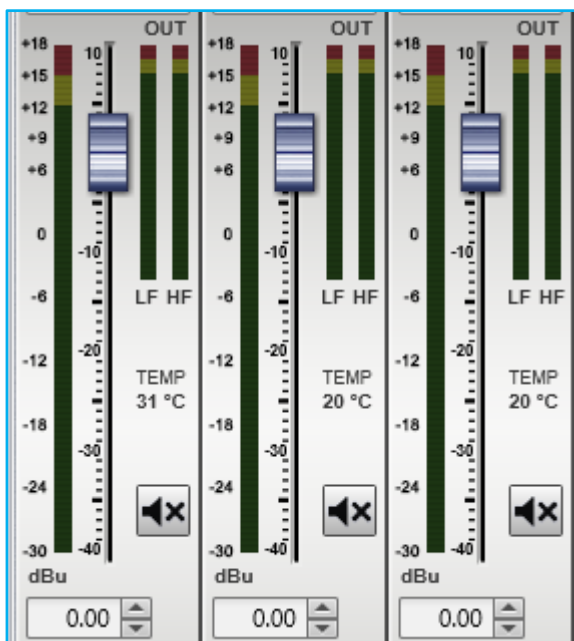

There is also a temperature read out showing the temperature of the DSP and amplifier module; -



There is delay available which is very useful for time aligning CDD-Live when used as an extra fill with a larger main system. The maximum delay available is 1 second. Values can either be typed directly into the Delay field or scrolled up and down using the arrow buttons. These increase or decrease the delay in increments of 10µs.

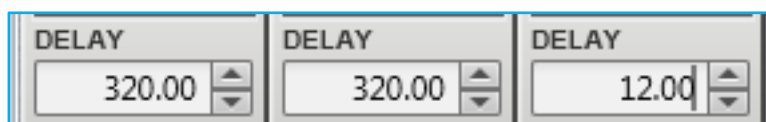

The Input allows the connection mode to be changed from the default which is Auto to Analogue or Dante. This can either be done individually for each CDD-LIVE or SXP or globally using the Input switch at the bottom of the overview Window. A global change will bring up the following window; -

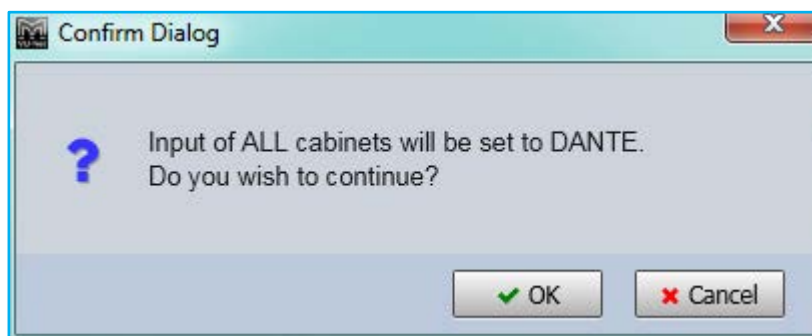

Click 'Cancel' if you have changed your mind or 'OK' to accept the change of input mode. All CDD-Live or SXP will display the new input selection.



The Snapshot button acts in the same way as the Load Snapshot function which is available from the right-click menu in the Project System Diagram. It will bring up the Snapshot Menu with the currently active Snapshot shown highlighted in green;-



Clicking on a new Snapshot number or letter will prompt you to confirm your selection; -

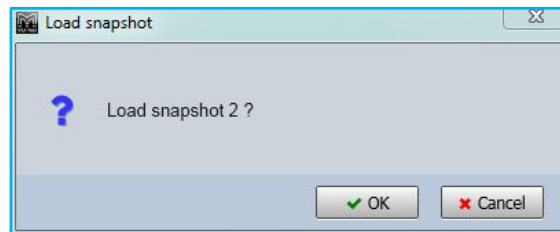

Clicking 'OK' will confirm the selection and the preset will load. The Preset select window can be closed. The currently active Snapshot is displayed on the Snapshot button; -

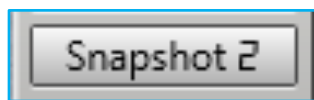

Polarity will invert the phase of the cabinet. If in Show Mode a confirmation window will appear; -

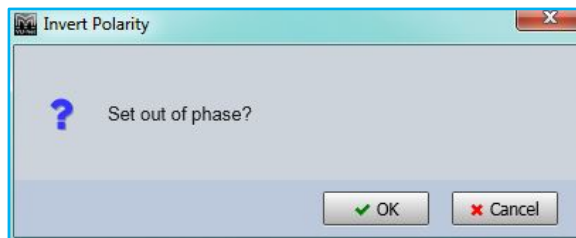

On clicking 'OK' the phase will be inverted and the Polarity button will turn green; -

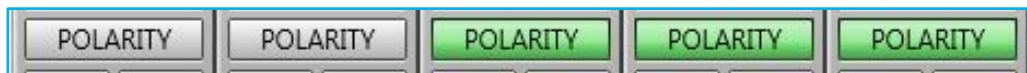





Clicking the LED button will illuminate the front grille LED to help identify the CDD-Live or SXP under control in multiple deployment applications. This can be done individually for any cabinet; -



Or globally using the LED controls at the bottom of the CDD or SXP Overview window; -



Pressing the "play" arrow  will make the LEDs of all CDD-Live and SXP illuminate in sequence, cycling round continually until you click on the stop button . Note that the global LED switches will overwrite any LEDs which have been activated on an individual CDD-Live or SXP. The back and forward buttons   allow manual cycling of all cabinet LEDs, each click will extinguish the currently illuminated LED and light the LED on the next or previous CDD-Live or SXP.

EQ

The EQ button will open the EQ tab for that particular CDD-Live or SXP speaker. The EQ window is virtually identical to all other Vu-Net controlled devices; -

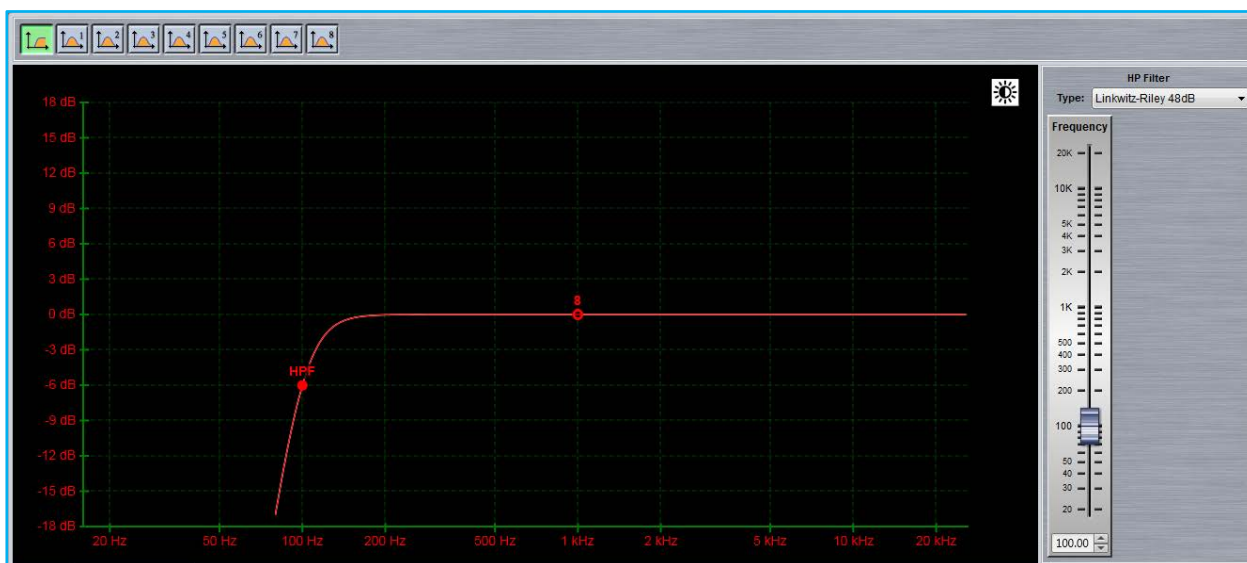

The window has three sections, the buttons along the top, the graphic display window and the controls on the right of the window. First we will look at the buttons along the top.

First there are ten parametric EQ buttons plus the high pass filter; -





As you can see there are a number of colour variations for these buttons. Unused bands are pale blue until they are selected for editing by clicking on them in which case the colour goes to a brighter blue and the image shows the button depressed. Unused is defined as the gain left at 0dB. Green buttons indicate a band that has either cut or boost applied, these will go a pale green when selected. Note that the high pass filter is always active so will always appear green.

The graphic view of the equalisation is a relatively standard frequency response graph; -

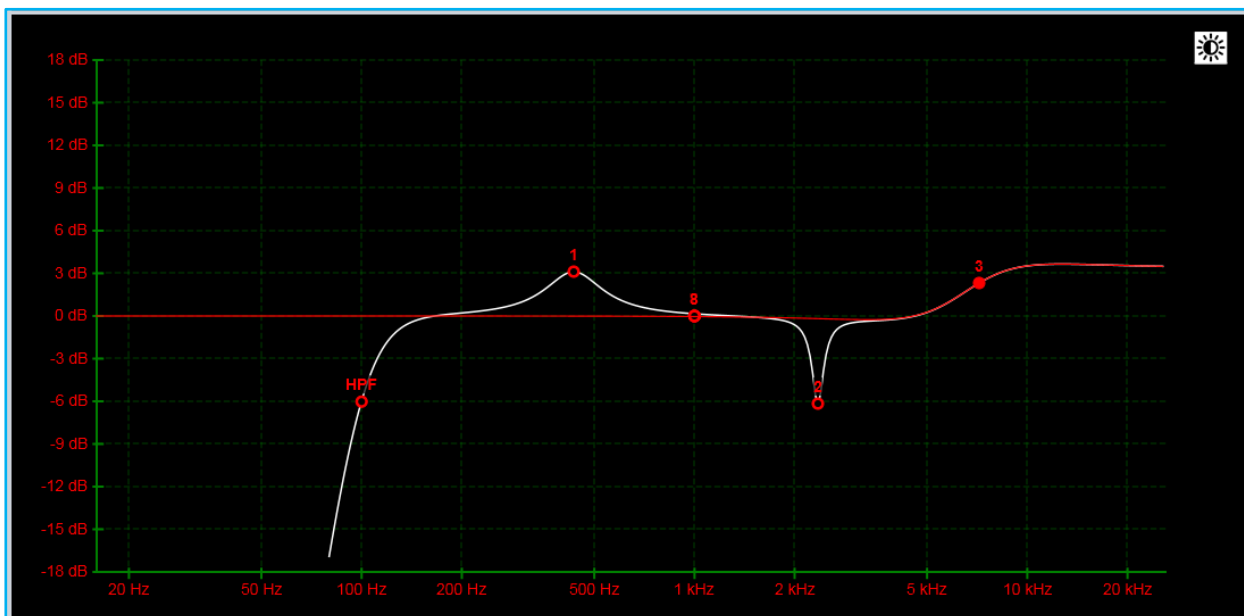

The horizontal axis is frequency in Hertz from 20Hz to 20KHz, the vertical axis is gain from -18dB up to +18dB. Colour coding is also used on the graph to represent the various modes.

First there are two traces, one red, and the other white. The red trace is the response of the band that is currently selected; the white trace is the overall response of the entire PEQ.

Each small red circle represents the position of each of the ten bands plus the high pass. For all of the EQ bands the position on the horizontal represents the EQ centre frequency, the vertical position is the cut or boost applied. A solid red circle is the currently selected band, any greyed-out band indicates that an EQ has been bypassed. The circle labelled "HP" identifies the cut-off frequency of the highpass filter.

In the right corner is this icon; -



This is used to cycle between standard and daylight modes. In daylight mode the display changes to look like this; -

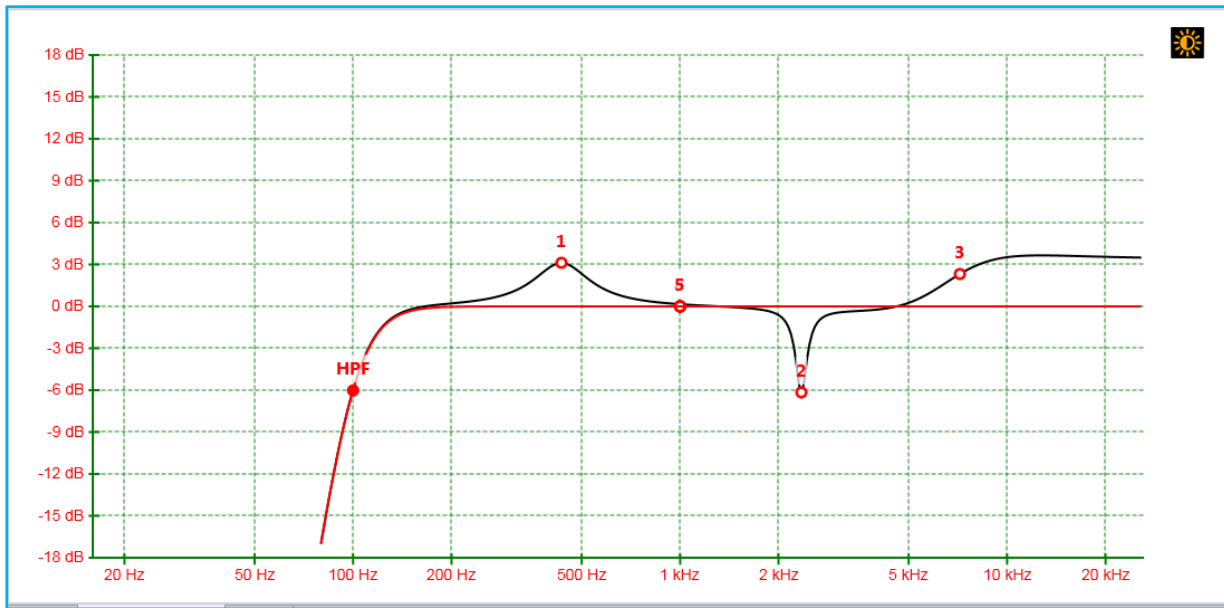

This is intended for use outdoors setting up a festival system where the normal display is difficult to view in bright sunlight. A further click on the icon will return to the default view.

In common with most PC controlled equalisation systems it is possible to make adjustments by dragging and dropping the filter curves. Left-click on any of the band rectangles and holding down the left mouse button, drag the icon horizontally to change the centre frequency or vertically to change the gain. Right-click and drag or Ctrl and drag up and down to adjust the filter Q factor. The graph will adjust and the audio adjustment will be made in real time.

The final section on the right of the window is the Properties panel; -

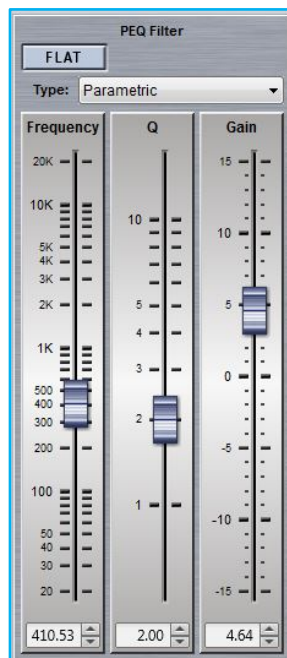

This shows all properties of the selected band. At the top is a flat button; -



This will zero the gain of the selected filter.

Next is a Filter type. Click on this and the drop down shows the options for each filter band; -

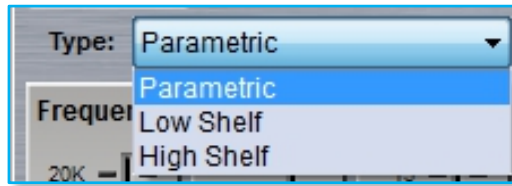

The default is Parametric, the other options are Low and High Shelf filters.

The High Pass Filter has the following options for filter type and slope; -

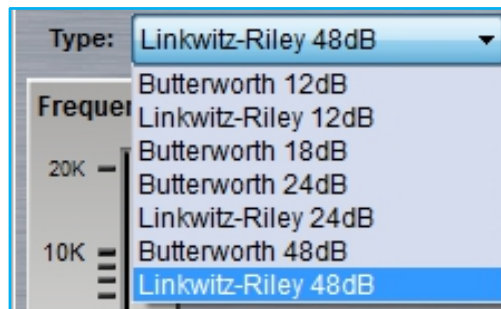

Below are the three principal faders for adjusting the filter parameters; -

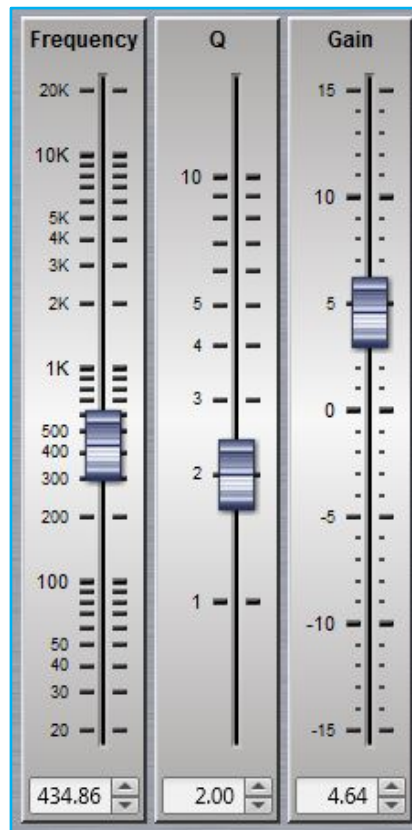

Parameters can be changed on the properties panel in three ways. The faders can be drag and dropped to a new value, the value can be scrolled up or down using the up/down buttons to the right of the value windows, and finally values can be directly typed



into the value windows. The response graph will adjust according to the new values and vice versa, adjustments in the graph window will be reflected in the fader positions and values in the properties panel.

To summarise, there are four ways to adjust filter parameters; -

1. Click and drag on the graph
2. Click and drag the properties faders
3. Use the up/down value buttons in the properties section
4. Directly type values into the value boxes.

Whilst this might seem over-versatility, it is intended to offer several options to suit the way that the system is being operated. If adjustments are being made with using a wireless tablet PC with a stylus whilst walking around a venue, certain options may be easier to use than if you were sitting at a desk with a mouse plugged in to the PC.

Zones

Any cabinet can be a member of any (or none) of the twenty zones available which are labelled A to T which will gang together all parameters for every cabinet in the zone. Note that all gain and delay parameters are *offset* ganged. If there is already a value entered before adding a CDD-Live or SXP cabinet to a zone this will be retained and subsequent changes to a value for any gain or delay to any cabinet in the same zone will increase or decrease all values according to any edits you make but will retain the offset between all values. To select a zone click on the Zone button at the top of the Overview page; -

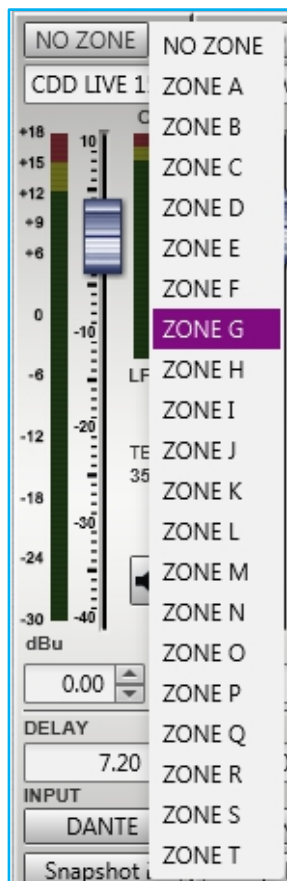

Click on the desired zone and it will be displayed on the zone button. The zones are colour coded to make it instantly obvious which cabinets are on the same zones. Colours are as follows; -

- | | |
|-------------|-----------------|
| A is Blue | K is Lavender |
| B is Red | L is Brown |
| C is Green | M is Turquoise |
| D is Yellow | N is Dark Brown |
| E is Black | O is Flesh |



F is Teal
 G is Deep Purple
 H is Moss Green
 I is Pink
 J is Dull Green

P is Light Green
 Q is Violet
 R is Sand
 S is Crimson
 T is Azure

All functions on cabinets in the same zone will be duplicated regardless of which cabinet in the zone is used to make adjustments. Note that all gain and delay parameters are *offset* ganged. If there is already a value entered before adding a CDD-Live to a zone this will be retained and subsequent changes to gain or delay to any cabinet in the same zone will increase or decrease all values according to any edits you make but will retain the offset between all values; -

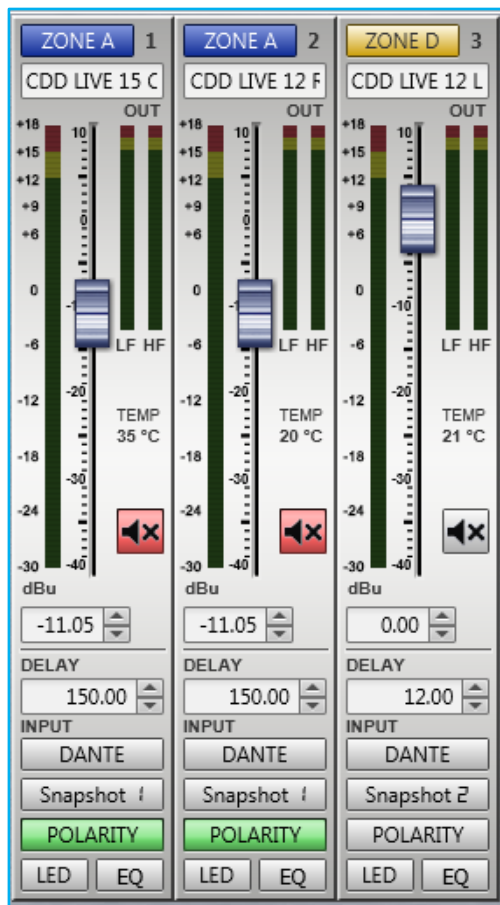

Firmware Updates

Martin Audio operate a program of continual improvement and from time to time firmware updates may be implemented to further the improve the performance of CDD-Live and SXP speakers. Firmware updates are incorporated in Vu-Net and the same process is used for all Vu-Net enabled devices.

In common with many digital systems, a firmware update puts the product in a venerable state known as “boot mode”. It is vital that the firmware update is not interrupted by either a mains outage, cable disconnect or closing Vu-Net. Any of these could render the product unusable which may mean a return to Martin Audio for repair therefore you should take every possible precaution before commencing a firmware update. ALWAYS use a hard-wired connection from your PC to the system, do not rely on Wi-Fi. Always use your PC with its mains PSU, do not rely on battery power. Try and ensure that your mains supply is reliable and is not likely to fail mid-update. Finally, the update process takes around 13 minutes per enclosure so on a large system is very time consuming. It is strongly recommended that firmware is checked when a system is prepped prior to a show back at your warehouse, it is not a task for set-up on a show day.

Important: Be aware that a firmware update will leave the cabinet in factory default mode once complete. The Input will be set to analogue and any presets or EQ applied to the cabinets will be lost so will have to be re-uploaded.

Get Firmware Updates

To make sure that you are loading the latest updates Vu-Net includes a system for checking that you have the latest firmware files installed so they are available to upgrade your system. The files are held in a server at Martin Audio and are accessed over the internet so to get the latest files you will need internet connectivity to your PC. Note that you can get Firmware update files completely independently, you do not need to be connected to an MLA system, the simple method is to take the tablet PC supplied with your system to your office, connect to the web and check for updates. Note also that whenever new firmware is released you will be notified by e-mail.

The Get Firmware Updates button is in the bottom right corner of the Vu-Net window; -

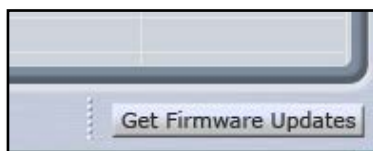

Click on the button and the following Window gives you three options; -

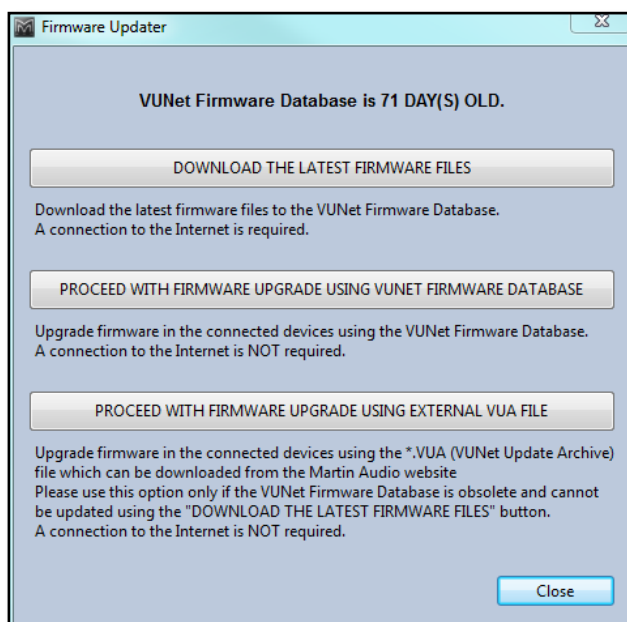

The first option as described accesses the firmware server via the internet. The URL for the Update file location is retained in the Vu-Net Preferences; -



Do not change this unless told to do so by Martin Audio!

Click on the 'DOWNLOAD THE LATEST FIRMWARE FILES' option and you will see the flowing window; -

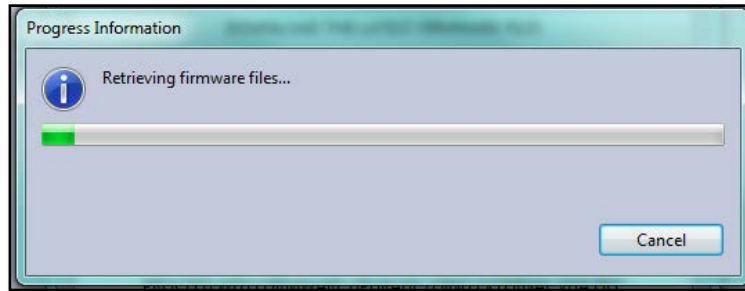

This is usually very rapid but depends on the speed of your internet connection. The latest files are now saved within Vu-Net ready for an upgrade. At the top of the Firmware Update window you will see; -

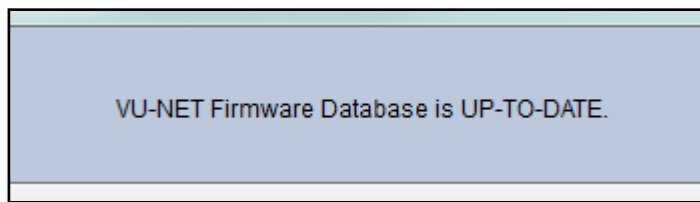

The Second option is to proceed with the update using the already installed firmware files. This is perfectly acceptable if you have already uploaded the latest files following a message from Martin Audio that there is a new release, or if you have periodically gone on line to load the latest files routinely. Clicking the 'PROCEED WITH FIRMWARE UPGRADE USING VUNET FIRMWARE DATABASE' button and the window closes, and the Firmware Update process starts.

The final option is to update the Firmware using an external VUA file. If for any reason you are unable to update the Firmware database via the internet if it is impractical to connect the Tablet PC for example, but have access to the web on another computer, it is possible to download the firmware file and transfer it to the system Tablet via a USB drive or similar.

Clicking on the 'PROCEED WITH FIRMWARE UPGRADE USING EXTERNAL VUA FILE' button will bring up a file browser. Navigate to the drive where the VUA file is located, in this case on a Martin Audio USB Key; -

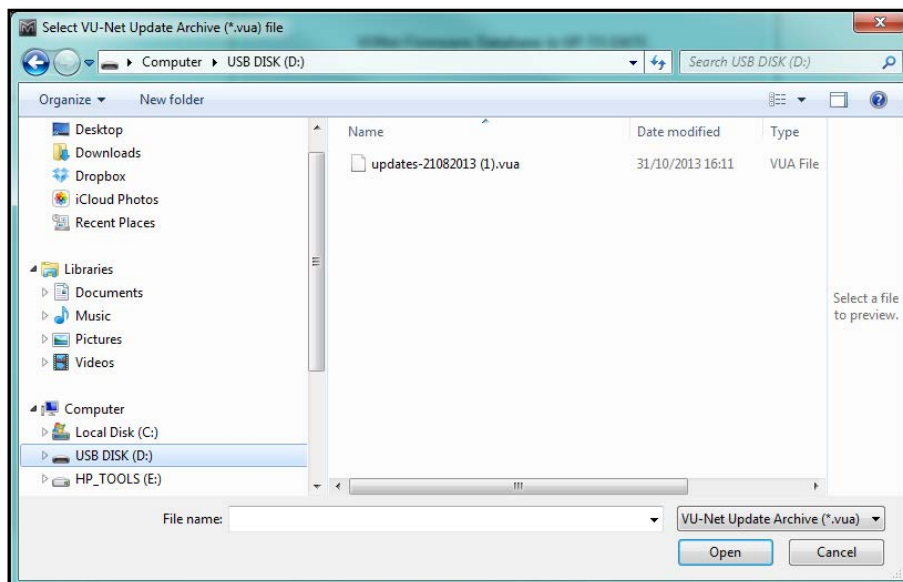

Select the VUA file, it will be saved, and the update wizard will commence.

Starting a Firmware Update.



Selecting the Firmware Update Wizard in the Vu-Net Tools menu opens the same window as the Get Firmware updates to double-check that you have the latest versions. Assuming that you have definitely installed the very latest versions you can click on 'PROCEED WITH FIRMWARE UPGRADE USING VUNET FIRMWARE DATABASE'. Vu-Net will scan the U-Net network for connected devices in the same way as a Device Discovery; -

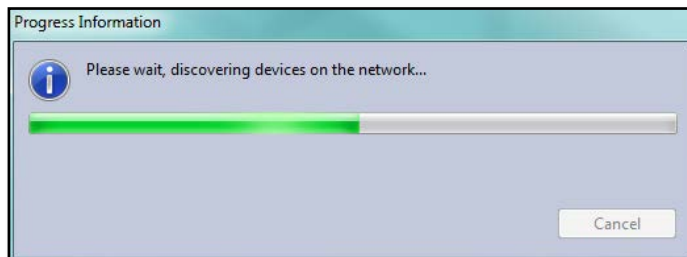

When the scan is complete, a window will appear with a list of all devices found together with their type, Serial number and the installed firmware; -

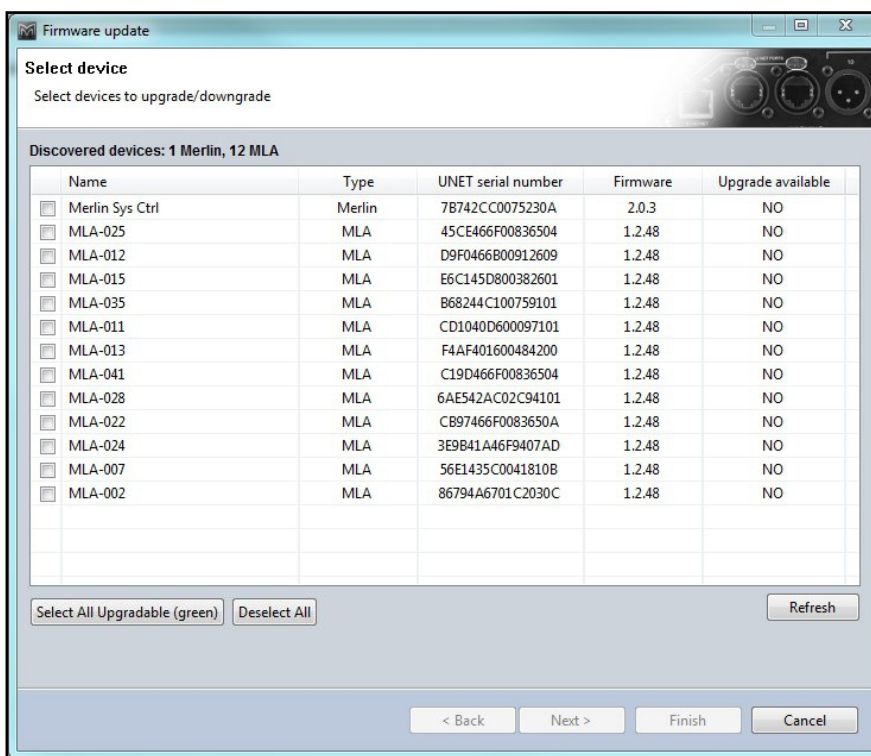

Vu-Net compares the discovered Firmware version with the latest version stored in its database and will indicate in the final column whether an upgrade is available. In this instance a single Merlin and twelve MLA have been found and all have up to date firmware however we can still proceed with an update to show how the process works.

In the left hand column there is a check box to select any device which you would like to update. The button at the bottom gives you the option to select all cabinets if required with a single click. If you have made an error in selecting devices you can use the 'Deselect' all switch to start again. We will do an update on the final two MLA; -

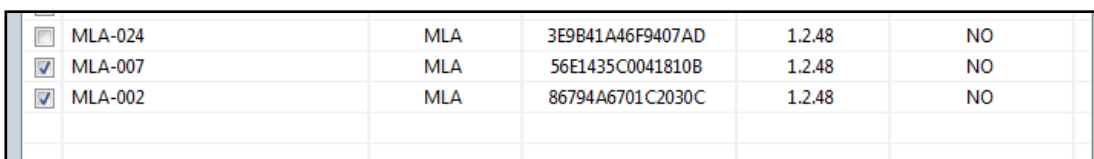

Click next and you see the following window; -

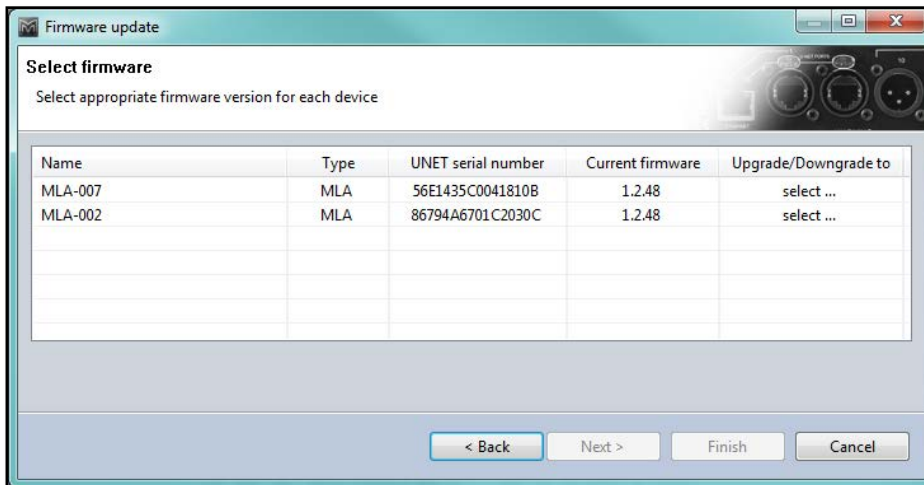

The current firmware is shown and the final column has an option to select the required firmware which in most cases would be a new version but could be an old firmware if say a bug has been found in a current version and it is necessary to downgrade to an earlier version. If there are several versions available, clicking on the Upgrade/Downgrade cell will bring up a drop-down showing the version numbers. Select the version you wish to use and it will appear in the final column; -

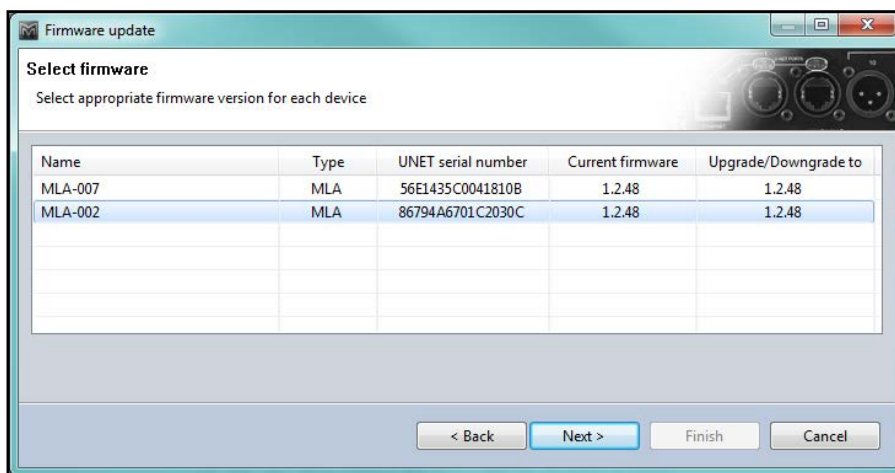

Click on 'Next' to start the update. You will first see the following warning to ensure that every measure has been taken to ensure that the update will complete successfully; -

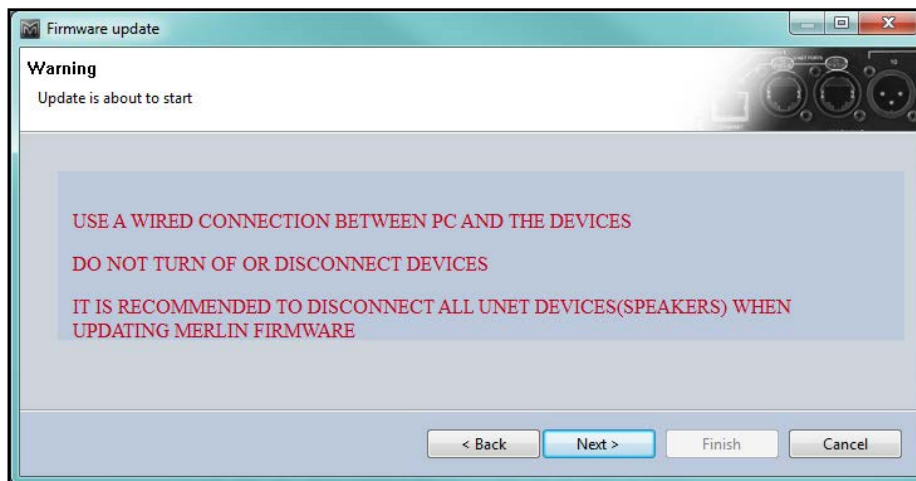



Click 'Next' and the upgrade will start. A progress window will appear showing the processes in the upgrade taking place. The system tackles one device at a time, placing it into Boot Mode, uploading the firmware and rebooting the device back into an operating mode; -

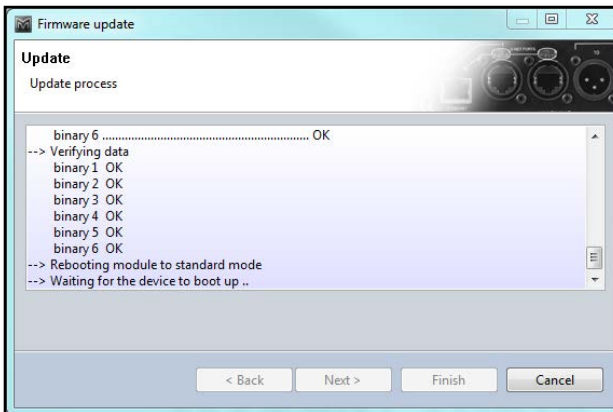
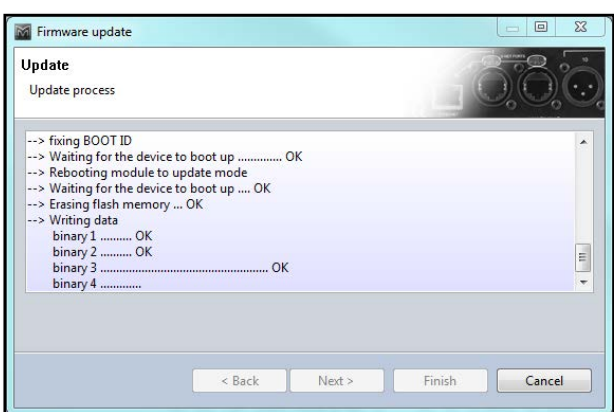
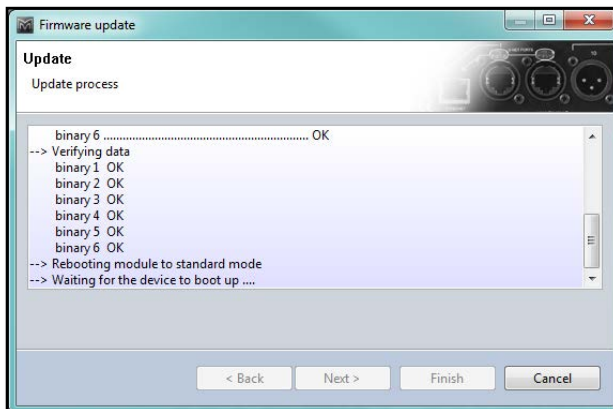
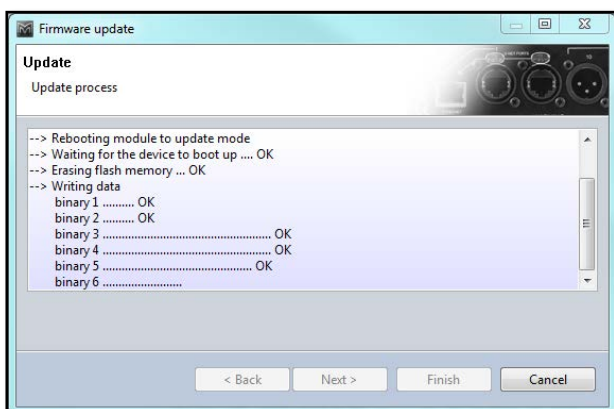

Once completed you will see the following; -

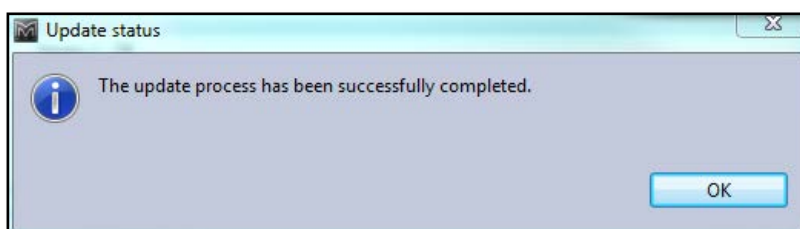

Click 'OK' and then click on 'Finish' on the Update Progress Window. The update is complete.

Important: Be aware that a firmware update will leave the cabinet in factory default mode once complete. The Input will be set to analogue and any presets or EQ applied to the cabinets will be lost so will have to be re-uploaded.

Restoring a CDD-Live or SXP module that is set to boot mode

If a CDD-Live amplifier firmware upgrade has been interrupted, there is a possibility that the module will be left in what is known as boot mode. This isn't a fault, it is an interim mode that is used during the firmware update process to allow the new firmware to be uploaded. When in this state however it is not possible to discover the product in Vu-Net and it will to all intents and purposes appear unusable (although it may still pass audio). The solution is to re-flash the firmware (even if it is definitely on the latest release).

To proceed with this operation, connect the unit to a computer running the latest version of Vu-Net (available [here](#)) and run the Firmware Update wizard by clicking on the 'Get Firmware Updates' button on the bottom right corner of the main page:

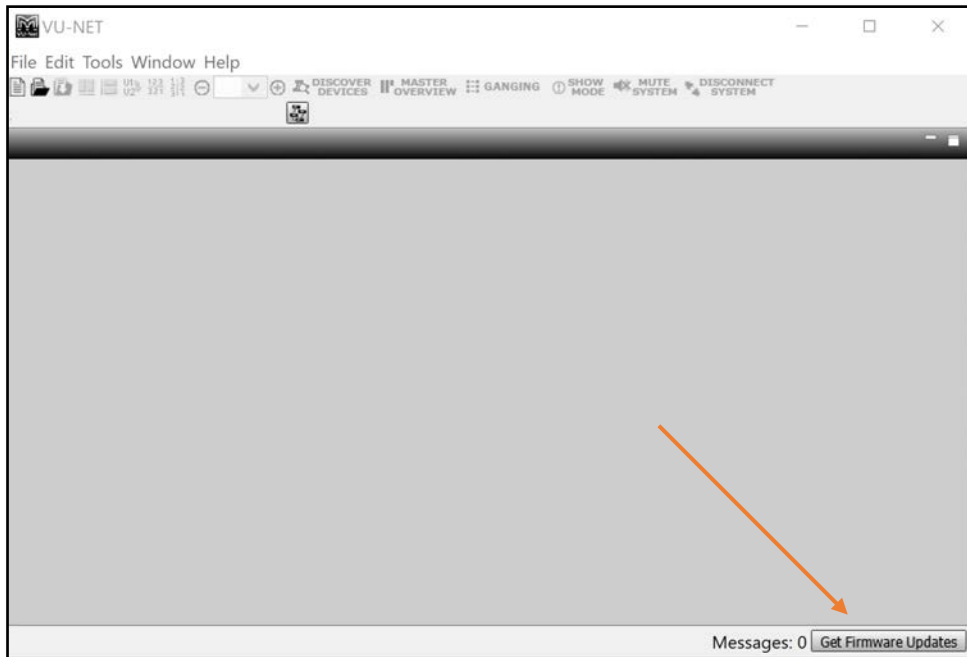

If Vu-Net is unable to see the unit, ensure the computer’s IPv4 settings are set to DHCP mode. Although a router/DHCP server is not required for this operation (single cabinet connected directly to the computer), it is advised, as it may take a few minutes for both units to acquire IP addresses in the same range.

If you are using a router/DHCP server and the computer still can’t see the unit, there is a chance the unit may be set to a static IP address which is out of range. If this is the case, you will need to discover the unit’s IP address first, and then set your computer to an IP address within the same range before proceeding with the Firmware Update.

Run your network’s ARP table and determine the unit’s IP address (or possible addresses)

One way of discovering your unit’s IP address is by looking at your ARP table. Start by turning off your WIFI adapter to exclude those results. Then open the Command Prompt (WIN+S ‘command prompt’) and type ‘arp -a’ followed by the “ENTER” key. A list similar to the one below should appear on your screen:

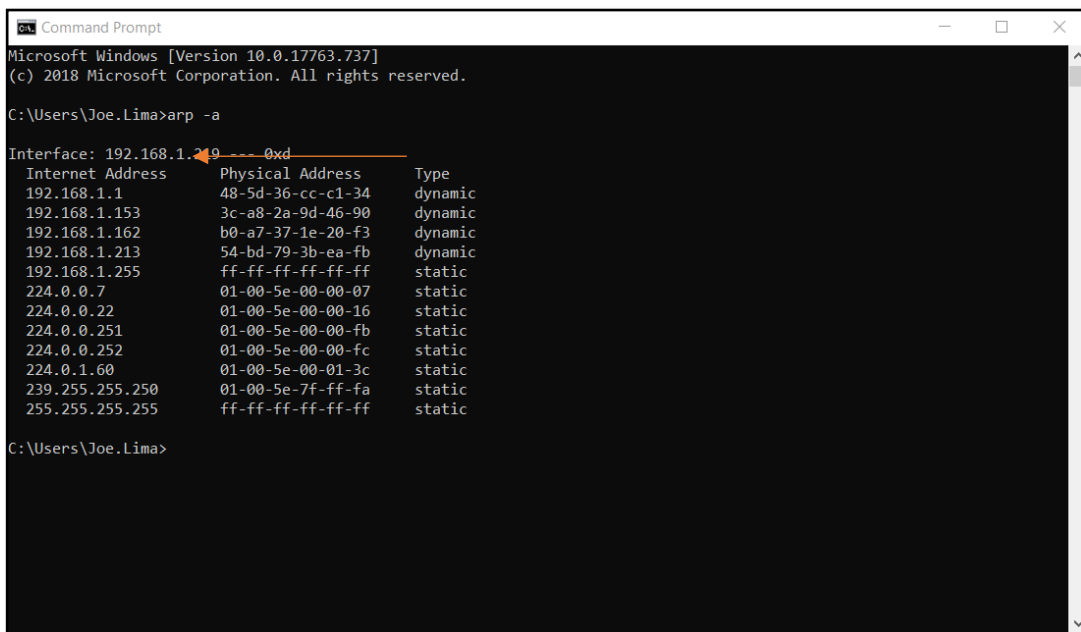



The ARP table matches IP addresses to MAC addresses within your network (*Internet Addresses to Physical Addresses as shown in the table*). It will list all available IP addresses and subnets. If you know your unit’s MAC address, you should be able to easily find its IP address in the table.

However, if the MAC address is also unknown, you will need to interpret the table contents. You can start by excluding all results that show a ‘dynamic’ IP address and focus on the ‘static’ ones. You’ll see that subnets (all results starting with 22x) will typically be set to ‘static’. You can exclude these.

In fact, there are only 4 private IP address ranges, so this should narrow down your options. Your unit’s address will most likely be within the following ranges:

- 10.0.0.0 to 10.255.255.255
- 169.254.0.0 to 169.254.255.255
- 172.16.0.0 to 172.31.255.255
- 192.168.0.0 to 192.168.255.255

Once you’ve excluded the addresses that do not fit in these ranges and/or are set to dynamic mode, you will hopefully have ended up with one result. If you have more than one possible IP address for your unit (and they are in different IP ranges), you will have to repeat step 2 for each possible IP range until Vu-Net is able to discover it.

Set your computer to a static IP address within the same range as your unit

The next step will be to set your computer to an available static IP address within the same range as your CDD-Live/SXP/CSX-Live module.

To do this, you will have to access your computer’s Ethernet settings (WIN+S ‘Ethernet settings’):

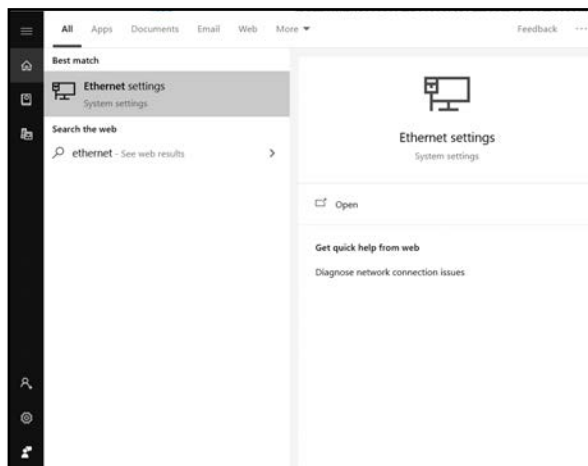

The following window should open: -

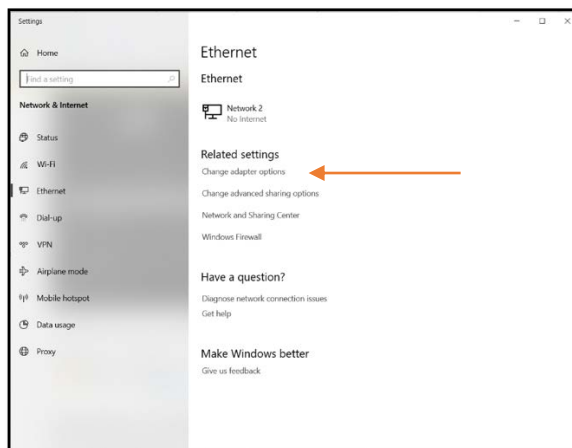

Click on 'Change adapter options' as indicated by the arrow above.

The following window should open: *(note the contents may vary depending on the structure of your network)*

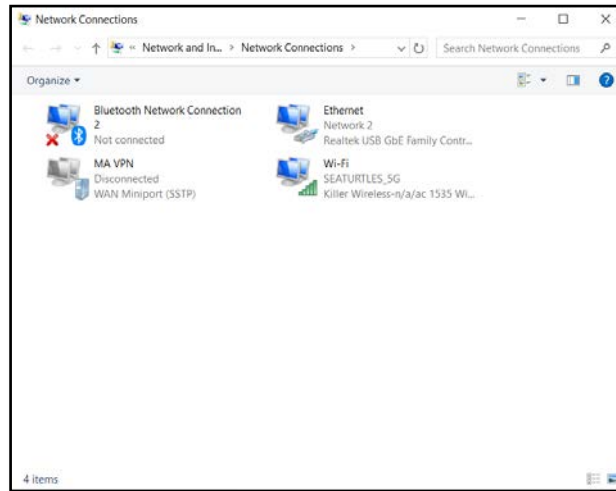

Right-click on the 'Ethernet' icon and select 'Properties': -

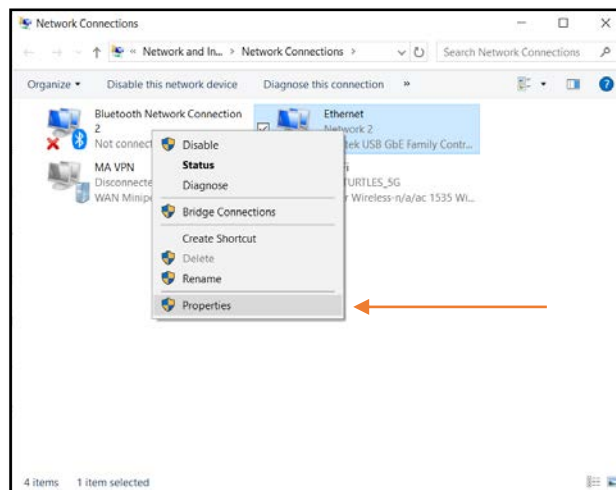

From the following menu, select 'TCP/IPv4' and click on 'Properties': -

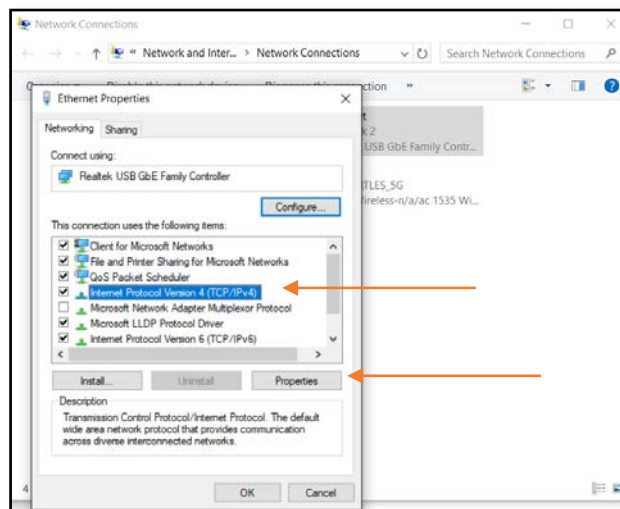

The following window should open: -

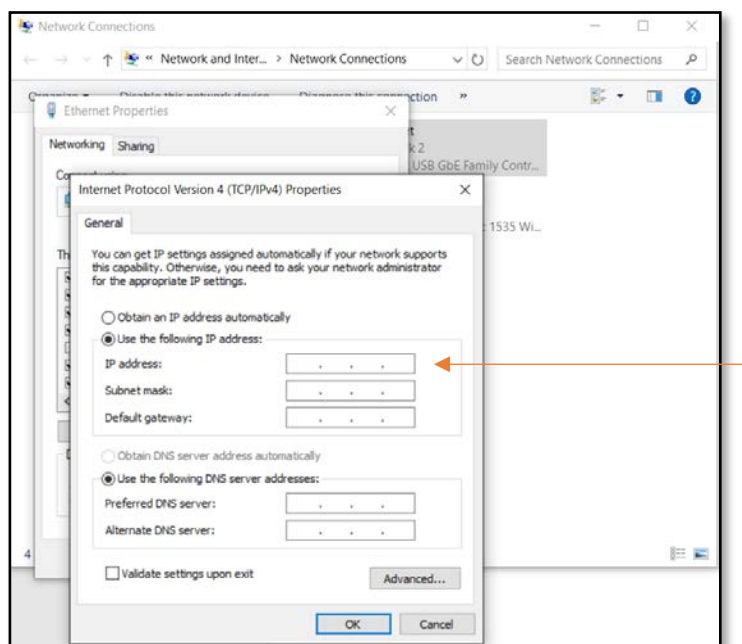

Check 'Use the following IP address' and type in an IP address within the range of your unit. Make sure this IP address is not in use (should not appear on your ARP table above). You can use any IP address that is not in that table, but you must ensure it is within the same range as your unit.

For example, let's assume you discovered that your unit's IP address is 172.16.1.32 and, according to the ARP table, that's the only address within that range in your network. Your computer's IP address must be set to 172.16.1.xxx (where xxx is any unused number between 1 – 255), for example 172.16.1.40

The next step is to set the subnet mask to 255.255.255.0

All other parameters should be left blank. Then hit 'OK' and exit all windows.

Launch Vu-Net and update your unit's firmware

Wait a couple of minutes for all networked devices to recognize each other and launch Vu-Net.

Proceed with the Firmware Update as described. Note that if you had more than one possible result after running your ARP table, you may have to go back and repeat step 2 for all the possible IP ranges until Vu-Net is able to 'see' your unit in the network.

Once the Firmware Update is complete, your unit should be restored to factory settings.

Module Reset Procedure

CDD-Live loudspeakers, SXP subwoofers and legacy CSX-Live subwoofers share the same power module, which may need to be reset from time to time, due to a number of reasons. For instance, if a unit has been set to a static IP address, and this information gets lost, a reset procedure will restore the network settings to auto/DHCP making it re-discoverable on Vu-Net.

To reset a CDD-Live/SXP/CSX-Live module, power on the cabinet and wait 10 seconds for the boot-up sequence to complete. Then press and hold the 'preset' button for about 15 seconds, until all 4 preset LED lights stay on. *Note that during this process they may flash intermittently.* Then power cycle the unit. It should now have its network card settings reverted to 'auto', allowing it to become discoverable on Vu-Net.

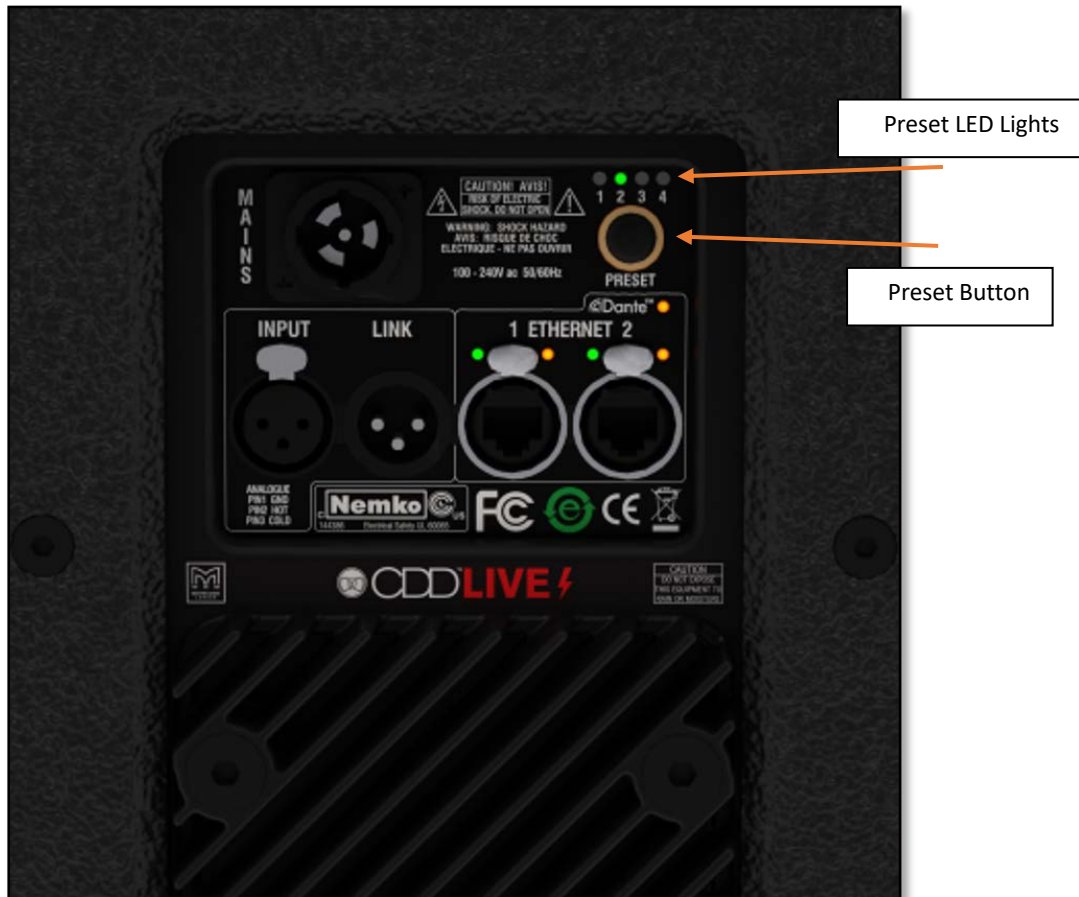

System Deployment

There are a host of mounting options for CDD-Live and SXP making the system extremely versatile for a wide range of applications both fixed installations and portable use. The wide range of accessories that are available for the range are used to implement the various system deployment options.

Safety

It is vital that good health and safety practice is observed in all cases when deploying any products from the CDD-Live range. When using speakers with a pole mount or speaker stand, particularly with the larger cabinets in the range, they must be lifted into position with two people. Flown systems must only be deployed by a trained, experienced rigger observing all local safety regulations both while the system is being rigged and during use. All flying points must have a working load sufficient to bear the weight of the CDD-Live speaker and secondary safety bonds should be used in all cases. Fixed installation should always use fixing methods appropriate to the material into which they are fitted.

Pole Mount

All three CDD-Live speakers incorporate a standard speaker stand "top hat" fitting on the base of the cabinet to allow use with a standard 35mm diameter speaker stand or pole.



The ASF20071 Wind-up pole is available as an optional accessory and can be used with either of the SXP subs to mount and of the CDD-Live cabinets.



The pole has an M20 threaded base which screws securely into the mounting plate on top of the SXP118 and side of the SXP218 (The SXP218 would be used in "Portrait" mode so the threaded fitting is upright). The top of the pole is a standard 35mm diameter fitting enabling any of the CDD-Live cabinets to easily fit on top.



The pole is then wound up to the desired height using the crank handle whilst keeping the safety button depressed.



Once at the desired height the handwheel is tightened to secure the pole in position and the crank handle can be folded away



Wall Mounting

CDD-Live 8 and CDD-Live 12 may be wall mounted either in portrait or landscape modes using the same wall brackets introduced for the CDD installation range. The CDD-Live 8 uses part number WB6/8B and CDD-Live 12 uses part number WB10/12B; -

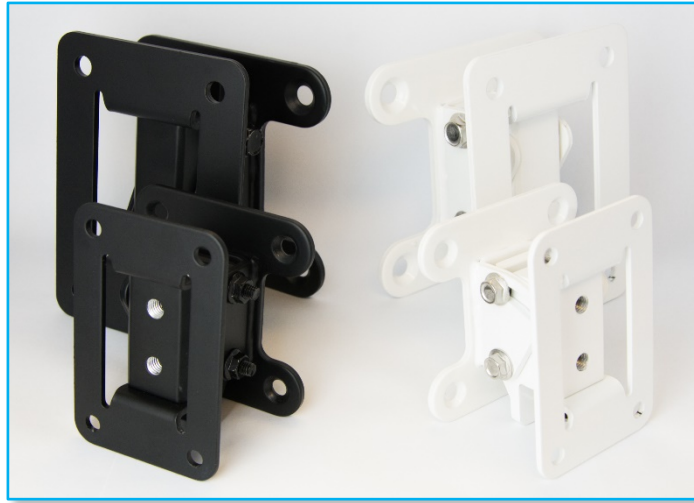

Do not forget that it is vital to rotate the driver through 90° when using a CDD-Live cabinet in landscape mode, please see the chapter on driver rotation for details on how this is achieved.

Installation is a two part process in common with standard first fix / second fix procedures, installation using both sizes of brackets is identical, the CDD-Live 12 bracket is just larger than the CDD-Live 8 version.

The first step is to separate the two halves of the bracket. There are two horizontally mounted nut and bolts holding the two halves together. The upper one which sits in a curved slot does NOT need to be removed. Unscrew the lower bolt and the cabinet bracket will lift off the wall bracket



First fix is to secure the wall section of the bracket. This is the part with four mounting holes, a vertical bolt holding the section which allows horizontal adjustment and the slot into which the cabinet bracket bolt sits. Use appropriate wall fixings suitable for the composition of the wall. These must be of sufficient strength to support the weight of the speaker, 14Kg for the CDD-Live 8 and 28Kg for the CDD-Live 12.



Next step is to attach the cabinet section of the bracket to the CDD-Live. This is the two-part section with the collar that mounts onto the wall section which in turn is hinged to allow vertical adjustment onto the cabinet bracket.

The rear of the cabinet has six countersunk bolts fitted in the amplifier module heatsink designed for use with the mounting brackets. For portrait mode remove the lower 4 bolts, for landscape mode remove the middle four; -



Position the bracket over the required holes orientated to suit the orientation that is being used and screw into place tightly using the bolts supplied with the bracket (note that you cannot use the bolts removed from the heatsink as they are too short).

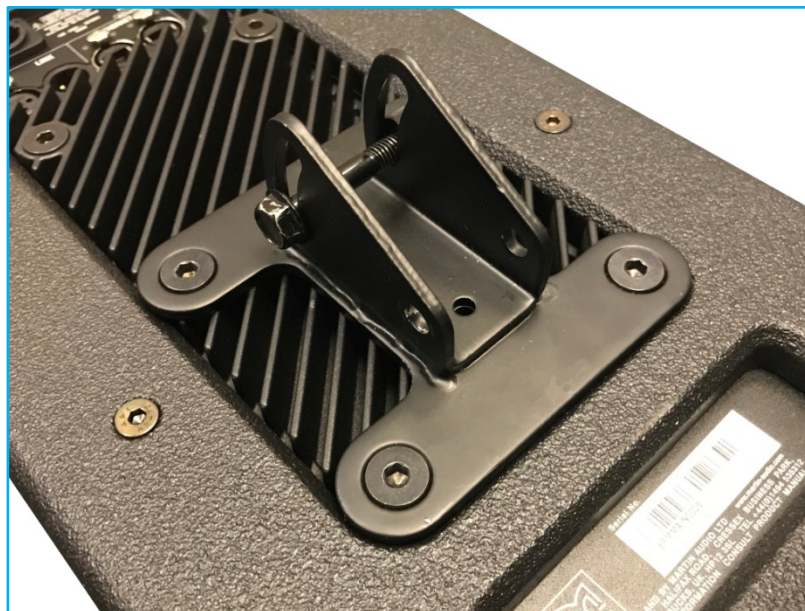
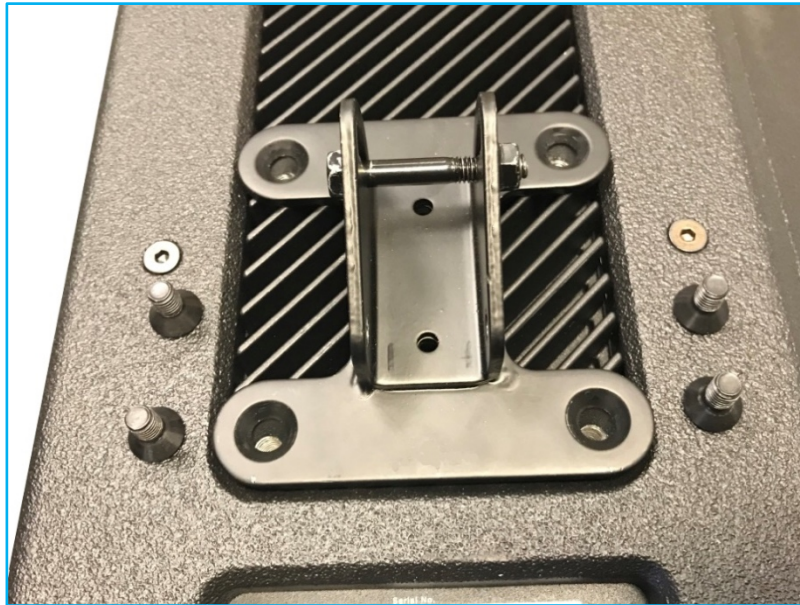

You are now ready to fit the speaker to the wall. Offer the speaker up to the bracket so you can hook horizontal bolt in the curved slot onto the notch on the ball bracket. Make sure that you follow appropriate safety measures if you are working at height such as using a scaffold tower or lifting platform which allows you to safely use both hands for this.



Once the bracket is hooked together and taking the weight of the cabinet you can replace the lower bolt.



Final adjustments can now be made. Horizontal (pan) adjustment is available by rotating assembly on the vertical bolt, when you're happy with the angle, the vertical securing bolt can be tightened with an M5 hex key (CDDWB8/6) or an M6 hex key (CDDWB10/12) to lock the position.



Vertical (tilt) adjustment is made by adjusting the grub screw:



Once the vertical position is fixed the two horizontal bolts can be tightened, this is best achieved by using a socket set with an extender bar to reach the bolt heads.

Ceiling Mount

The CDD-Live 8 may be mounted on the ceiling (in landscape mode only) using the Ceiling Mount Bracket part number CDDCB6/8B



Do not forget that it is vital to rotate the driver through 90° when using a CDD-Live cabinet in landscape mode, please see the chapter on driver rotation for details on how this is achieved.

The first step is to disassemble the bracket, unscrewing the cabinet section from the ceiling arm using an M6 hex key to undo the securing bolt.



Fix the ceiling bracket assembly to the ceiling. There are three 6.5 mm holes and a central 13 mm hole in the bracket for this purpose. It is essential that appropriate fixings are used to allow safe and secure attachment to the ceiling material, particularly as these may be fitted overhead public areas. The fixings to be used will depend on the ceiling construction. Use the larger central 13 mm hole as the principal fixing initially: this lets you adjust the bracket to obtain the correct horizontal coverage by pivoting it on the single mounting. When the position is correct, tighten it, and add further fixings to the other three holes to ensure a safe and secure mounting.



Second stage is to fit the cabinet bracket in place. The bracket is attached orientated as shown by removing four screws in the rear heatsink with an M4 hex key and attaching the bracket with the same screws. The 4 screws in the middle of the cabinet must be used to allow fitting in landscape.

Offer the cabinet up the ceiling bracket arm and mate the cabinet bracket section with the ceiling bracket arm by threading the M6 bolt with spring washer through the cabinet bracket as shown below. Do not fully tighten the bolt at this stage, leave a little play so the vertical dispersion can be adjusted.

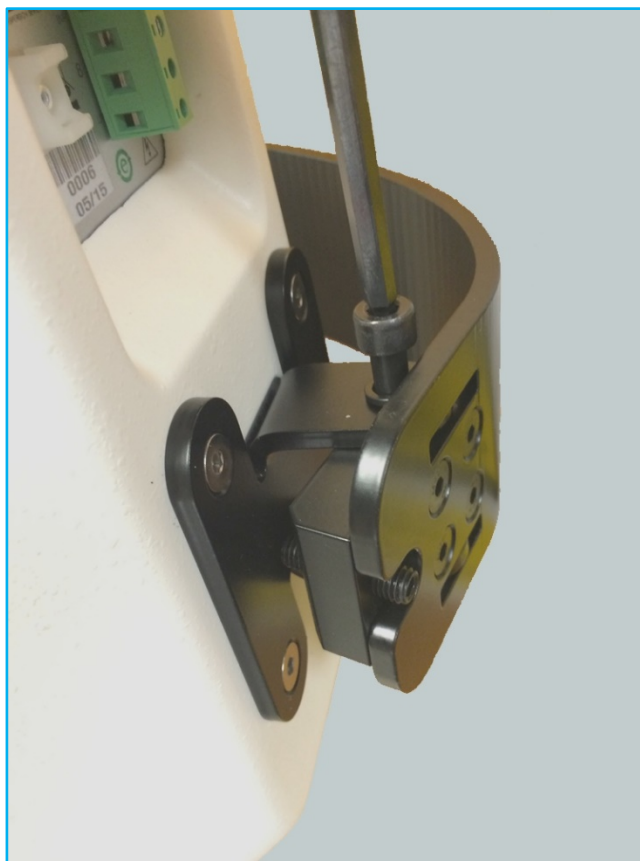

The vertical dispersion can be adjusted using the grub screw accessed from the rear of the bracket:

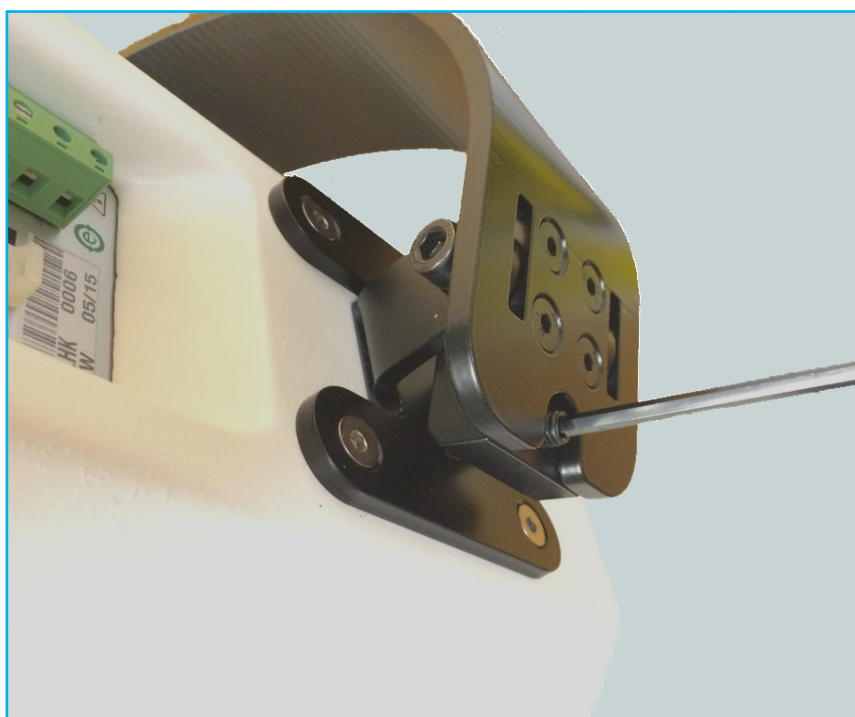

Universal Bracket



The universal bracket is a highly flexible bracket that allows a host of mounting options. It can be used for flown applications either in portrait or landscape mode. This could be a permanent installation by bolting the bracket to a suitable surface using the central mounting hole, or a portable system using a scaffold clamp to attach to a pole or truss. (Note that the scaffold clamp is not supplied);-



By adding a pole mount adaptor, part number ASF20045 which is available as an optional accessory, the universal bracket can be used for speaker stand or pole mounted applications giving the added benefit of having adjustment available for up or down tilt; -



There are dedicated Universal Brackets for each of the CDD-Live speakers, part numbers are as follows; -

- CDD-Live 8 CDDLUB8B
- CDD-Live 12 ASF20046
- CDD-Live 15 ASF20048

There is a slight difference in the design and fitting of the CDD-Live 8 Universal Bracket so we will look at fitting that model first.

Fitting the CDDLUB8B Universal Bracket

The only tool required to fit the Universal Bracket is an M5 Hex (Allen) Key. First remove the two M8 bolts that will be used to fit the bracket on one of the three possible orientation. These are the screws that need to be removed; -

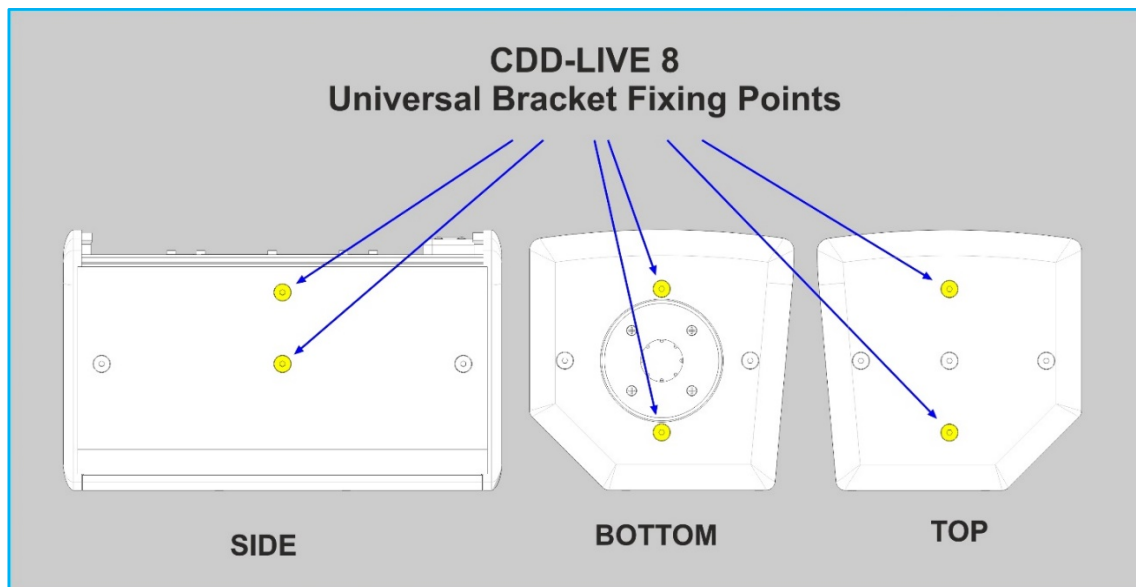

Position the universal Bracket and screw in place using the screws removed from the cabinet, ensure that they are fully tightened. If fitting to the side of the cabinet note that you attach through the central hole in the bracket and the one at the back, fitting to the top and bottom the holes at the front and back are used, the central hole is not used.

If you are using the universal bracket on the side of the cabinet don't forget to change the orientation of the driver, please see the chapters on removing the grill and rotating the driver and badge.



If required attach the scaffold clamp or pole mount adaptor and the cabinet is ready to be used. Once fitted in position the Handwheel is loosened and the cabinet freely angled up or down, the bracket will slide on the carriage. Once you have established the desired cabinet angle tighten the Handwheel. The Universal Bracket is asymmetrical and can be used either way round. It allows tilt of up to 20° in one direction and 23° in the other.

Fitting the ASF20046 or ASF20048 Universal Bracket

The ASF20046 and ASF20048 Universal Brackets are used with the CDD-Live 12 and Live 15 respectively. They are identical in design but scaled accordingly to suit the size of each cabinet. Fitting them is the same for each but is slightly more involved than the procedure for the CDD-Live 8.

As with the CDD-Live 8 the bracket can be fixed on the top, bottom or side of the cabinet, the first step is to remove the screws at the mounting position once you have decided which orientation you are use. These are the screw mounting positions:-

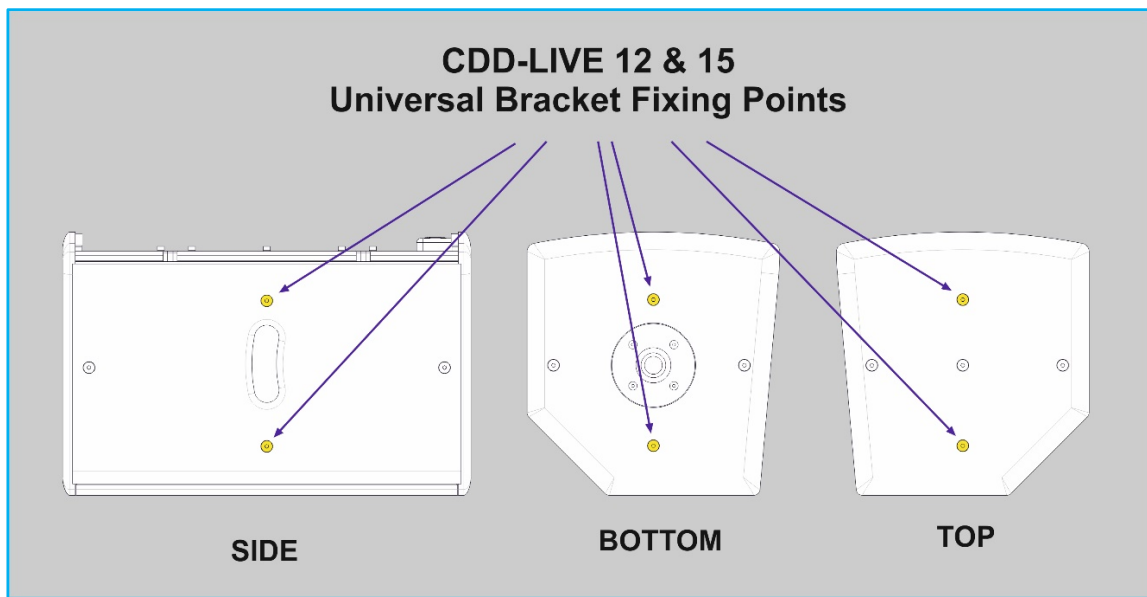

The screws that you have removed are no longer required, the bracket **MUST** be attached with the M8 x 35mm screws supplied with the Universal Bracket. The screws that are supplied in the cabinet are not long enough and not rated for suspending the cabinet so will be unsafe.



Position the bracket and attach with the M8x35mm screws and fully tighten; -

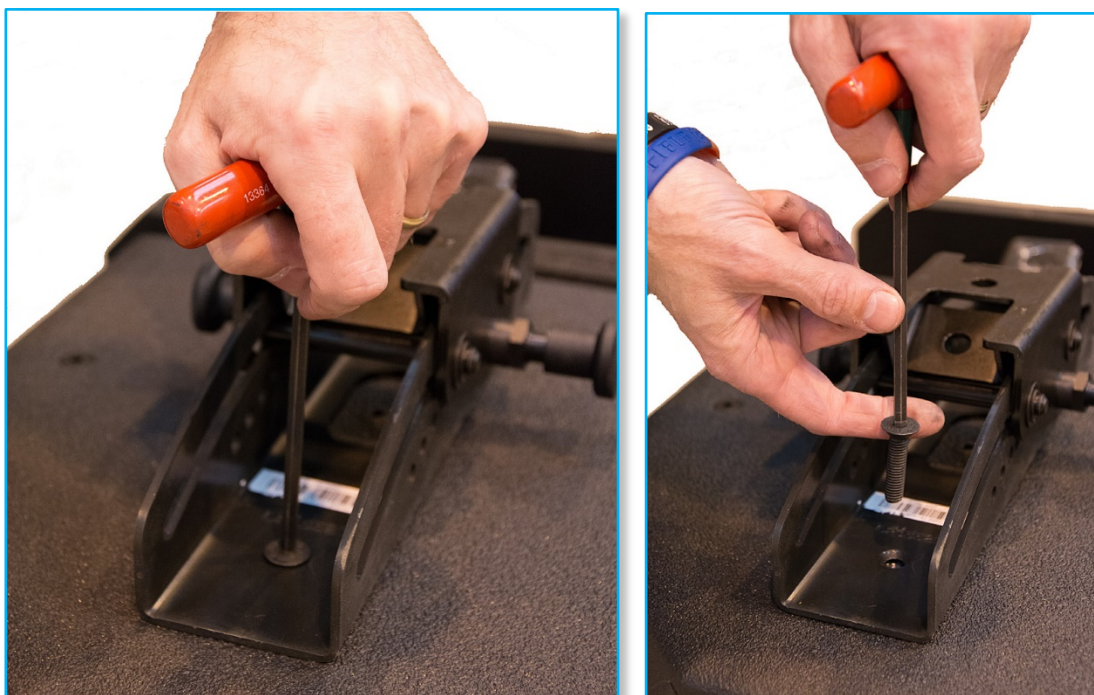

The Universal Bracket has two fixing positions for a scaffold clamp, pole mount adaptor or other fixing method. These change the available angles for up and down tilt. The top fixing position is the default and should always be used for pole mount applications, the alternative angle fixing point towards the rear gives an additional 30° of down-tilt for flown applications. Also supplied with the Universal bracket is an aluminium spacer block. This may be used on the angle fixing position when attaching a scaffold clamp to allow greater horizontal rotation if required.

The Universal Bracket should be fitted in position, suspended or mounted on a pole as required. To adjust the angle the plungers are pulled out each side and rotated 90° to temporarily hold them in an unlocked position. The cabinet is then tilted up or down as required, the bracket will slide in an arc on the carriage. Once in the desired position the plungers are then turned a further 90° so they spring back into position. Adjust the cabinet a fraction up and down to ensure that the plunger pins have securely located into the holes on the Arc Bracket. The angles available in each of the index holes are as follows (note that these angles refer to a flown system with positive angles as down tilt and negative as up-tilt)

Central Mounting Hole	Rear Angled mounting hole
15°	45°
12.5°	42.5°
10°	40°
8°	38°
6°	36°
4°	34°
2°	32°
0°	30°
-2°	28°
-4°	26°
-6°	24°
-8°	22°
-10°	20°
-12.5°	17.5°
-15°	15°

Yoke Mounting

Yokes are available for all three CDD-Live full range cabinets; the product numbers are as follows; -

CDD-Live 8	CDDL YA8B
CDD-Live 12	CDDL YA12B
CDD-Live 15	CDDL YA15B



These allow a number of options for both portable and permanent installations. They can be wall mounted vertically allowing horizontal adjustment of coverage, wall or ceiling mounted horizontally with vertical adjustment available, and by using a scaffold clamp or pole mount adaptor in the 13mm central fixing hole, they can be used in horizontal mode either flown or mounted on a speaker stand.



All three models are essentially the same design, just scaled to the appropriate size for each cabinet. Fitting is identical for all three versions.

A 5mm Hex (Allen) key and 13mm or adjustable Spanner (wrench) are required.

The yokes attach to the cabinet top and bottom (relative to portrait orientation). One arm of the yoke carries a 35mm spigot which located in the speaker mount top hat fitting in the bottom of the cabinet, the other arm has a fixing plate which is bolted to the central M8 insert on the top of the cabinet.

Attachment to the top of the cabinet is with either the M8 handwheel or M8 x 40 bolt supplied with the yoke; -



The handwheel is for portable applications where adjustment is necessary once the speaker is in position, the M8 x 40mm bolt is for permanent installations where the tilt adjustment needs to be tightened off permanently.

The first step is to remove the M8 bolt from the centre of the top of the cabinet using the 5mm Allen key



To fit the yoke first the upper arm needs to be pivoted upwards so there is enough room to locate the spigot into the speaker top hat. The upper arm is attached with two M8 bolts, the bolt in the corner acts as a pivot and the second bolts approximately 60mm along the upper arm from the corner locks the arm in place to prevent it from pivoting so this screw needs to be temporarily removed using the 13mm spanner;-



Slot the spigot into the top hat fitting on the base of the cabinet; -



Then attach the upper arm to the top of the cabinet through the central M8 insert from which the M8 screw was removed. Use with the M8 handwheel or the M8 x 40mm bolt. Use the spring washer (first) then the plain washer (second) onto whichever fixing you are using, pass it through the hole in the mounting plate and into the cabinet insert. Tighten it sufficiently to make handling easy but allow for final adjustment.

Finally replace the M8 x 70mm bolt in the yoke upper arm to fix it in place and tighten

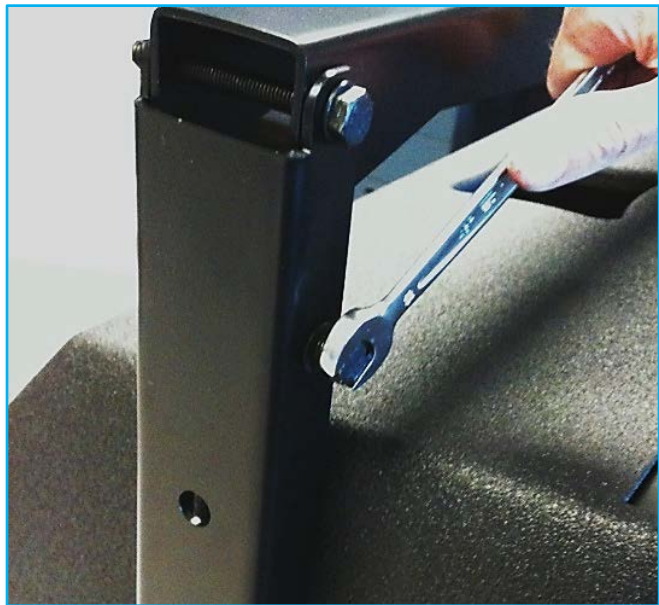

Note that for portable use it is advisable to fit the scaffold clamp or pole mount adaptor before attaching the yoke to the cabinet. For fixed installations the yoke would be attached to the wall or ceiling using appropriate fixings and then the cabinet fitted to the yoke.

Eye Bolt Mounting

All CDD-Live and SXP systems have threaded inserts rated for flown applications. All CDD-Live enclosures have M8 threaded inserts and both SXP have M10 inserts. Most commonly these are used in conjunction with shouldered eye bolts for suspending the cabinets using appropriately rated chain or steel wire. Martin Audio's HTK00003 (M8) and HTK00004 (M10) are rated for use in flown applications. Note that if you plan to use alternative eye bolts these must be shouldered cast or machined steel NOT formed steel types commonly available from DIY stores. They must have a safe working load rating compatible with the weight of the cabinets.



The CDD-Live enclosures can be flown in 'Portrait' or 'landscape' format, note that the driver must be rotated when the cabinet is used in landscape mode, please see the chapter on grille removal and driver rotation.

We recommend using a minimum of four eye bolts with which to suspend the cabinet irrespective of which orientation is used. In most applications two eye bolts are used as the primary support left and right. A third attaches to the rear of the cabinet and is used to adjust the down-tilt of the cabinet as required. The fourth eye bolt is used to attach a secondary safety line which should be attached to a secure mounting point which is independent of the primary flying point- round a girder or similar.



Upgrading to Weatherised

CDD-LIVE8, 12 & 15

The procedure for weatherising is identical for all three CDD-LIVE models.

NOTES:

- Please follow the instructions carefully. This must be done to ensure that the speakers meet IP24 rating and are safe for use outdoors.
- Take care when disassembling parts, some of them to be re used to ensure that they are in good condition when re-assembled.
- Use label remover if required when removing membranes.
- Ensure that all information on the serial number label is visible through the membrane window and aligned correctly once assembled.

1. Place the speaker face down (use a carpet or other soft surface to protect the grille from damage)



2. Remove fixing bolts holding the rear trim in place. These are as follows; -
 - **CDD-LIVE 8** Using a 4mm Hex bit remove 4 x M6x50mm from the top and bottom of the cabinet. Using a 2.5mm hex bit remove the remaining 4 x M5x25mm bolts
 - **CDD-LIVE12 & 15** Using a 5mm Hex bit, remove 4 x M8x50 from the top and bottom positions. Using a 4mm Hex bit remove the remaining 8 x M6x50 bolts.

Keep bolts in a safe place for re-use

3. Remove the Amplifier trim panel.



4. Remove the non-IP Version membrane (plastic sticker) and replace it with the new IP version supplied with the kit; -



It may be necessary to use a label remover spray to remove the old label and any adhesive residue prior to fitting the new membrane.

5. Remove the backing paper from the serial number over-membrane which is the transparent sticker

6. Stick the over-membrane in position over the serial number as shown; -



7. Take the new weatherised amplifier frame including the cowl and position it over the amplifier module. Screw it down using the bolts removed in step 2 starting with two of the bolts in opposite corners; -



8. Next the grille needs to be upgraded. Place the speaker on its back with the grill facing up. Apply pressure to the centre of the grille with a flat hand; -

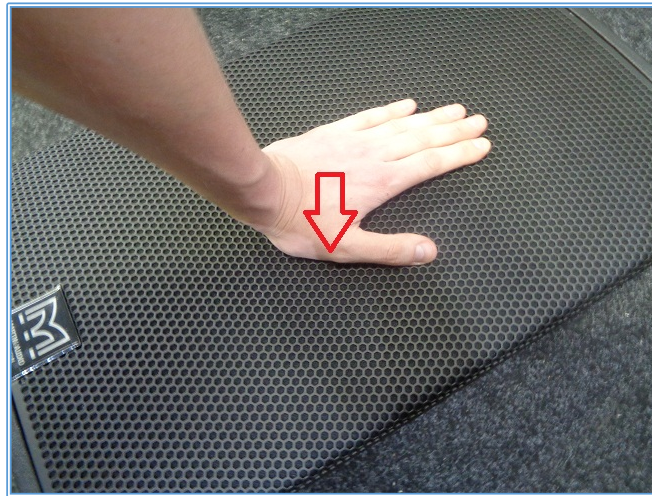

9. As mentioned in the chapter on grille removal, use a flat head screwdriver to level the grill up and out of its slot using the cut-outs in the side; -



10. Place the removed grille face down; -



11. Position the supplied Declon foam over the grille cloth; -



12. Place the secondary grille over the Declon foam. The flat side of the mesh needs to go face down making contact with the Declon; -



These images show close-ups showing the correct orientation; -

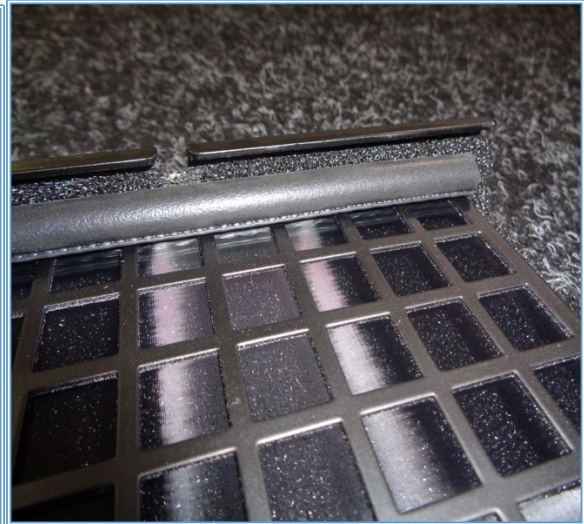

13. Take an M4 x 100 wood insert; -



14. Fix wood insert into a hole at the bottom side of cabinet using 4mm Hex Bit.

NOTE: Some cabinets might already have wood inserts, 20mm studs and rubber bumpers. If so – studs have to be removed (both top and bottom side of cabinet).



15. CDD-LIVE8 Only. Position an M4 washer over the fitted insert; -



16. Screw the M4 x 12mm hex spacer into the threaded insert; -

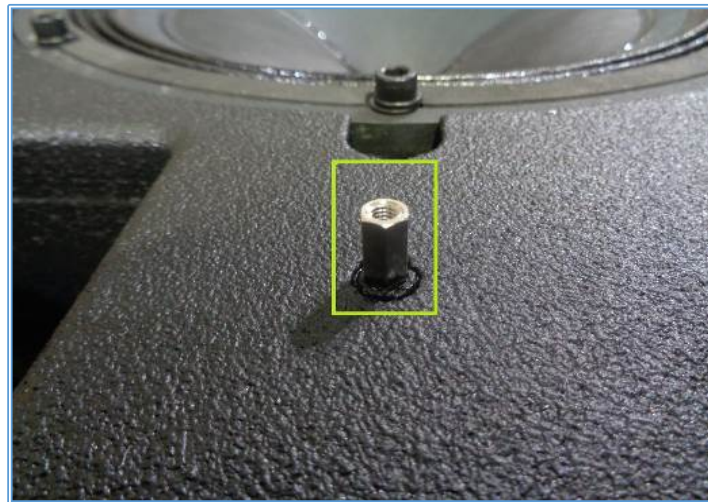

17. Fit a rubber bumper to the top of the spacer. CDD-LIVE15 Only, also add an M4 washer and M4 x 25mm spacer; -

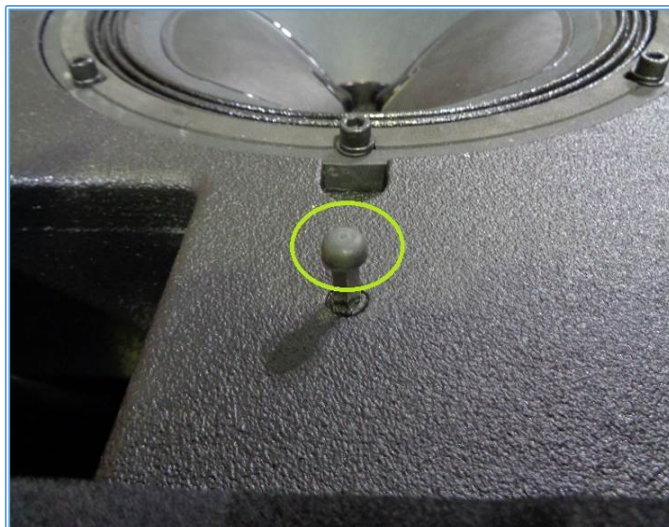

CDD-LIVE8 & 12



CDD-LIVE15

18. Remove backing paper and fit a 5cm gasket strip to the recess above the cabinet identification LED; -



19. Re-fit the grille to the cabinet by locating one side into the grille recess, gently bend the grille outwards until the opposite side fits into the recess slot on that side.



The cabinet is now upgraded to IP24.

SXP118, SXP218 (CSX-LIVE118 & CSX-LIVE218)

The procedure for weatherising is identical for both SXP (formerly CSX-LIVE) models.

NOTES:

- Please follow the instructions carefully. This must be done to ensure that the speakers meet IP24 rating and are safe for use outdoors.
- Take care when disassembling parts, some of them to be re used to ensure that they are in good condition when re-assembled.
- Use label remover if required when removing membranes.
- Ensure that all information on the serial number label is visible through the membrane window and aligned correctly once assembled.

1. Place cabinet face down. Use a piece of clean carpet or another soft material to protect the grille from damage. Using a 4mm Hex bit, remove 8 x M6x30mm countersunk screws around the amplifier module trim.



Remove the amplifier trim.

Retain the screws for re-use

2. Turn over wooden trim and remove serial number mounting plate by removing 2 x 8 x $\frac{3}{4}$ Pozidrive screws.

Retain screws and serial number plate for re-use

3. Remove the CDD-LIVE NON-IP version membrane from the back of the module and replace with IP24 version; -



4. Attach 2 x Adhesive Backed Loop Coins on to the fan bracket where shown; -



5. Take the serial number over-membrane (transparent sticker) and remove the backing paper; -



6. Stick the over-membrane label over the serial number mounting plate; -



7. Take the serial number panel gasket and stick over the serial number mounting plate; -



8. Screw down completed modified serial number plate to the rain cowl assembly frame using the 2 x 8x3/4 Pozidrive screws removed in step 2; -



9. Place the rain cowl frame and screw down using the 8 x M6x30mm Countersunk screws removed in step 1. Screw down two opposite corners first.



The cabinet is now upgraded to IP24.

Current Draw and Thermal Dissipation

CDD-LIVE8

AC CURRENT		WATTS (V.I.Cosφ)			THERMAL DISSIPATION	
230V	115V	OUT	IN	DISSIPATED	BTU/hour	Kcal/hour
Power On, Amplifiers Idle, No Input (Quiescent)						
0.11A	0.165A	0	15	15	51	12.9
Pink Noise Input, Driven to Limiter Thresholds						
0.6A	1.2A	105	120	30	102	26

CDD-LIVE12

AC CURRENT		WATTS (V.I.Cosφ)			THERMAL DISSIPATION	
230V	115V	OUT	IN	DISSIPATED	BTU/hour	Kcal/hour
Power On, Amplifiers Idle, No Input (Quiescent)						
0.163A	0.22A	0	19	19	65	16
Pink Noise Input, Driven to Limiter Thresholds						
1.2A	2.4A	184	250	85	290	73

CDD-LIVE15

AC CURRENT		WATTS (V.I.Cosφ)			THERMAL DISSIPATION	
230V	115V	OUT	IN	DISSIPATED	BTU/hour	Kcal/hour
Power On, Amplifiers Idle, No Input (Quiescent)						
0.163A	0.22A	0	19	19	65	16
Pink Noise Input, Driven to Limiter Thresholds						
1.2A	2.4A	184	250	85	290	73

SXP118

AC CURRENT		WATTS (V.I.Cosφ)			THERMAL DISSIPATION	
230V	115V	OUT	IN	DISSIPATED	BTU/hour	Kcal/hour
Power On, Amplifiers Idle, No Input (Quiescent)						
0.12A	0.20A	0	17	17	58	15
Pink Noise Input, Driven to Limiter Thresholds						
1.73A	3.46A	270	380	127	433	109

SXP218

AC CURRENT		WATTS (V.I.Cosφ)			THERMAL DISSIPATION	
230V	115V	OUT	IN	DISSIPATED	BTU/hour	Kcal/hour
Power On, Amplifiers Idle, No Input (Quiescent)						
0.23A	0.30A	0	28	128	96	24
Pink Noise Input, Driven to Limiter Thresholds						
3.4A	6.8A	535	750	243	830	235

Specifications

CDD-Live 8

Acoustics

TYPE	Ultra-compact, Coaxial Differential Dispersion powered two-way system
FREQUENCY RESPONSE (1)	70Hz – 20kHz \pm 3dB, -10dB @ 50Hz
DRIVER	LF: 8" (200mm)/2" (50mm) voice coil, long excursion, shared ferrite motor system with HF HF: 1" (25mm) exit/1.4" (38mm) voice coil, polyimide dome compression driver
INPUT SENSITIVITY	-13dBu for 100dB SPL
MAXIMUM SPL (2)	117dB continuous / 123dB peak
DISPERSION	110°-80° horizontal, 60° vertical (user-rotatable)
CROSSOVER	2.4kHz Active LR8 Balance presets for pole mount/ pole mount with sub/ stage monitor

Audio input

CONNECTORS	Female XLR input, male XLR link output, Dante Audio Neutrik® Ethercon
ANALOGUE INPUT IMPEDANCE	20 k Ω balanced to ground
MAXIMUM ANALOGUE INPUT LEVEL	24.6 Vpp (+21dBu), over voltage protected

Internal Processing

	Multi-channel DSP, programmable via TCP/IP using VU-Net software
	PEQ/shelving filters
	Up to 48dB/Oct HPF
	Low latency HF FIR filters
	Up to 200ms input delay
	Pre-set selection via rear panel switch

Network

CONNECTORS	2x Neutrik® EtherconRJ45
PROTOCOL	TCP/IP and UDP/IP

Amplifier Module

TYPE	2 channel switch-mode, class D
PEAK OUTPUT POWER	1300W
CONTINUOUS OUTPUT POWER	650W total
AVERAGE EFFICIENCY	89%
COOLING	External convection cooled, with internal fan
MAXIMUM AMBIENT TEMPERATURE	40°C (104°F) for full output

Power Supply

TYPE	Switch mode, fixed frequency with PFC
AC INPUT OPERATING RANGE	85 – 265V – AC, 50 – 60Hz
POWER FACTOR	> 0.98
NOMINAL POWER CONSUMPTION	550W
MAINS CONNECTOR	Neutrik® PowerCon True1

Mechanical

ENCLOSURE	Extensively braced multi-laminate plywood.
FINISH	Textured black PU coating.
PROTECTIVE GRILLE	HEX perforated mild steel with protective zinc plating and black powder coat finish. Backed with black grille cloth
FITTINGS	Top hat for pole mounting 15 x M8 mounting points Single pocket handle Optional weather protection cowl
IP RATING	IP24 factory option available
DIMENSIONS	(W) 258mm x (H) 428mm x (D) 254mm (W) 10.16in x (H) 16.85in x (D) 10.00in
WEIGHT	14kg (30.8lbs) excluding Transit cover
ACCESSORIES	Transit Cover Optional wall, yoke and universal brackets

CDD-Live 12

Acoustics

TYPE	Compact, Coaxial Differential Dispersion powered two-way system
FREQUENCY RESPONSE (1)	62Hz – 20kHz \pm 3dB, -10dB @ 50Hz
DRIVER	LF: 12" (300mm)/2.5" (63.5mm) voice coil, long excursion, shared ferrite motor system with HF HF: 1" (25mm) exit/1.7" (44mm) voice coil, polyimide dome compression driver
INPUT SENSITIVITY	-18dBu for 100dB SPL
MAXIMUM SPL (2)	122dB continuous / 128dB peak
DISPERSION	110°-60° horizontal, 60° vertical (user-rotatable)
CROSSOVER	1.8kHz Active LR8 with low latency HF FIR equalisation Balance presets for pole mount/ pole mount with sub/ stage monitor

Audio input

CONNECTORS	Female XLR input, male XLR link output, Dante Audio Neutrik® Ethercon
ANALOGUE INPUT IMPEDANCE	20 k Ω balanced to ground
MAXIMUM ANALOGUE INPUT LEVEL	24.6 Vpp (+21dBu), over voltage protected

Internal Processing

	Multi-channel DSP, programmable via TCP/IP using VU-Net software
	PEQ/shelving filters
	Up to 48dB/Oct HPF
	Low latency HF FIR filters
	Up to 200ms input delay
	Pre-set selection via rear panel switch

Network

CONNECTORS	2xNeutrik® Ethercon
PROTOCOL	TCP/IP and UDP/IP

Amplifier Module

TYPE	2 channel switch-mode, class D, Bridged Tied Load + 1 channel switch-mode, class D
PEAK OUTPUT POWER	2500W
CONTINUOUS OUTPUT POWER	1250W
AVERAGE EFFICIENCY	89%
COOLING	External convection cooled, with internal fan
MAXIMUM AMBIENT TEMPERATURE	40°C (104°F) for full output

Power Supply

TYPE	Switch mode, fixed frequency with PFC
AC INPUT OPERATING RANGE	85 – 265V ~ AC, 50 - 60Hz
POWER FACTOR	> 0.98
NOMINAL POWER CONSUMPTION	550W
MAINS CONNECTOR	Neutrik® PowerCon True1

Mechanical

ENCLOSURE	Extensively braced multi-laminate plywood.
FINISH	Textured black PU coating.
PROTECTIVE GRILLE	HEX perforated mild steel with protective zinc plating and black powder coat finish. Backed with black grille cloth
FITTINGS	Top hat for pole mounting 15 x M8 mounting points Two side pocket handles Optional weather protection cowl
IP RATING	IP24 factory option available
DIMENSIONS	(W) 359mm x (H) 580mm x (D) 373mm (W) 14.13in x (H) 22.83in x (D) 14.69in
WEIGHT	28kg (61.6lbs) excluding Transit cover
ACCESSORIES	Transit Cover Optional wall, yoke and universal brackets

CDD-Live 15

Acoustics

TYPE	High-output, Coaxial Differential Dispersion powered two-way system
FREQUENCY RESPONSE (1)	55Hz – 20kHz ±3dB, -10dB @ 45Hz
DRIVER	LF: 15" (380mm)/3" (75mm) voice coil, long excursion, shared ferrite motor system with HF HF: 1.4" (36mm) exit/3" (75mm) voice coil, titanium dome compression driver
INPUT SENSITIVITY	-20dBu for 100dB SPL
MAXIMUM SPL (2)	126dB continuous / 132dB peak
DISPERSION	100°-60° horizontal, 60° vertical (user-rotatable)
CROSSOVER	1.7kHz Active LR8 with low latency HF FIR equalisation Balance presets for pole mount/ pole mount with sub/ stage monitor

Audio input

CONNECTORS	Female XLR input, male XLR link output, Dante Audio Neutrik® Ethercon
ANALOGUE INPUT IMPEDANCE	20 kΩ balanced to ground
MAXIMUM ANALOGUE INPUT LEVEL	24.6 Vpp (+21dBu), over voltage protected

Internal Processing

	Multi-channel DSP, programmable via TCP/IP using VU-Net software
	PEQ/shelving filters
	Up to 48dB/Oct HPF
	Low latency HF FIR filters
	Up to 200ms input delay
	Pre-set selection via rear panel switch

Network

CONNECTORS	2xNeutrik® Ethercon
PROTOCOL	TCP/IP and UDP/IP

Amplifier Module

TYPE	2 channel switch-mode, class D, Bridged Tied Load + 1 channel switch-mode, class D
PEAK OUTPUT POWER	2500W
CONTINUOUS OUTPUT POWER	1250W
AVERAGE EFFICIENCY	89%
COOLING	External convection cooled, with internal fan
MAXIMUM AMBIENT TEMPERATURE	40°C (104°F) for full output

Power Supply

TYPE	Switch mode, fixed frequency with PFC
AC INPUT OPERATING RANGE	85 – 265V ~ AC, 50 - 60Hz
POWER FACTOR	> 0.98
NOMINAL POWER CONSUMPTION	550W
MAINS CONNECTOR	Neutrik® PowerCon True1

Mechanical

ENCLOSURE	Extensively braced multi-laminate plywood.
FINISH	Textured black PU coating.
PROTECTIVE GRILLE	HEX perforated mild steel with protective zinc plating and black powder coat finish. Backed with black grille cloth.
FITTINGS	Top hat for pole mounting 15 x M8 mounting points Two side pocket handles Optional weather protection cowl
IP RATING	IP24 factory option available
DIMENSIONS	(W) 427mm x (H) 696mm x (D) 422mm (W) 16.81in x (H) x 27.42in (D) 16.61in
WEIGHT	37kg (81.4lbs) excluding Transit cover
ACCESSORIES	Transit Cover Optional yoke and universal brackets

SXP118

Acoustics

TYPE	Compact, direct radiating powered subwoofer
FREQUENCY RESPONSE (3)	47Hz – 150Hz \pm 3dB, -10dB at 41Hz
DRIVER	18" (460mm)/4" (100mm) voice coil, long excursion, ferrite magnet, waterproof cone
INPUT SENSITIVITY	-20dBu for 100dB SPL (CDD12/15 pre-set) -13dBu for 100dB SPL (CDD8 pre-set)
MAXIMUM SPL (4)	132dB continuous / 135dB peak
DISPERSION	Omnidirectional / or Cardioid (paired)
CROSSOVER	Active Presets for CDD-Live 8, 12 & 15 mono-pole or cardioid (paired)

Audio input

CONNECTORS	Female XLR input, male XLR link output, Dante Audio Neutrik® Ethercon
ANALOGUE INPUT IMPEDANCE	20 k Ω balanced to ground
MAXIMUM ANALOGUE INPUT LEVEL	24.6 Vpp (+21dBu), over voltage protected

Internal Processing

	Multi-channel DSP, programmable via TCP/IP using VU-Net software
	PEQ/shelving filters
	Up to 48dB/Oct LPF
	Up to 200ms input delay
	Pre-set selection via rear panel switch

Network

CONNECTORS	2xNeutrik® Ethercon
PROTOCOL	TCP/IP and UDP/IP

Amplifier Module

TYPE	2 channel switch-mode, class D, Bridged Tied
PEAK OUTPUT POWER	2000W
CONTINUOUS OUTPUT POWER	1000W
AVERAGE EFFICIENCY	89%
COOLING	External fan
MAXIMUM AMBIENT TEMPERATURE	40°C (104°F) for full output

Power Supply

TYPE	Switch mode, fixed frequency with PFC
AC INPUT OPERATING RANGE	85 – 265V ~ AC, 50 - 60Hz
POWER FACTOR	> 0.98
NOMINAL POWER CONSUMPTION	550W
MAINS CONNECTOR	Neutrik® PowerCon True1

Mechanical

ENCLOSURE	Extensively braced multi-laminate birch plywood.
FINISH	Textured black PU coating.
PROTECTIVE GRILLE	HEX perforated mild steel with protective zinc plating and black powder coat finish.
FITTINGS	Two skids on base, with mating channels on top Four rear-mounted 100mm (4in) castors M20 top-mounted thread plate for pole mounting 16 x M10 mounting points 2x Bar handles, 1 on each side 4x fittings for optional transit cover Optional weather protection cowl
IP RATING	IP24 factory option available
DIMENSIONS	(W) 600mm x (H) 509mm x (D) 632mm (760mm including castors) (W) 23.62in x (H) 20.04in x (D) 24.86in (29.90in including castors)
WEIGHT	50kg (110lbs) excluding Transit cover
ACCESSORIES	Transit Cover

SXP218

Acoustics

TYPE	Dual-driver, direct radiating powered subwoofer
FREQUENCY RESPONSE(3)	35Hz – 150Hz \pm 3dB, -10dB @ 30Hz
DRIVER	2x 18" (460mm)/4" (100mm) voice coil, long excursion, ferrite magnet, waterproof cone
INPUT SENSITIVITY	-20dBu for 100dB SPL (CDD12/15 pre-set) -13dBu for 100dB SPL (CDD8 pre-set)
MAXIMUM SPL (4)	140dB continuous / 143dB peak
DISPERSION	Omnidirectional / or Cardioid (paired)
CROSSOVER	Active Presets for CDD-Live 8, 12 & 15 mono-pole or cardioid (paired)

Audio input

CONNECTORS	Female XLR input, male XLR link output, Dante Audio Neutrik® Ethercon
ANALOGUE INPUT IMPEDANCE	20 k Ω balanced to ground
MAXIMUM ANALOGUE INPUT LEVEL	24.6 Vpp (+21dBu), over voltage protected

Internal Processing

	Multi-channel DSP, programmable via TCP/IP using VU-Net software
	PEQ/shelving filters
	Up to 48dB/Oct LPF
	Up to 200mS input delay
	Pre-set selection via rear panel switch

Network

CONNECTORS	2xNeutrik® EtherconRJ45
PROTOCOL	TCP/IP and UDP/IP

Amplifier Module

TYPE	Two 2 channel switch-mode, class D, Bridged Tied Load
PEAK OUTPUT POWER	4000W
CONTINUOUS OUTPUT POWER	2000W
AVERAGE EFFICIENCY	89%
COOLING	External fan
MAXIMUM AMBIENT TEMPERATURE	40°C (104°F) for full output

Power Supply

TYPE	Switch mode, fixed frequency with PFC
AC INPUT OPERATING RANGE	85 – 265V ~ AC, 50 - 60Hz
POWER FACTOR	> 0.98
NOMINAL POWER CONSUMPTION	550W
MAINS CONNECTOR	Neutrik® PowerCon True1

Mechanical

ENCLOSURE	Extensively braced multi-laminate birch plywood
FINISH	Textured black PU coating
PROTECTIVE GRILLE	HEX perforated mild steel with protective zinc plating and black powder coat finish
FITTINGS	Two skids on base, with mating channels on top Four rear-mounted 100mm (4in) castors 24 x M10 mounting points 4x Bar handles, 2 on each side 4x fittings for optional transit cover Optional weather protection cowl
IP RATING	IP24 factory option available
DIMENSIONS	(W) 1085mm x (H) 537mm x (D) 792mm (920mm including castors) (W) 42.72in x (H) 21.13in x (D) 31.16in (36.20in including castors)
WEIGHT	105kg (231lbs) excluding Transit cover
ACCESSORIES	Transit Cover

Notes

- (1) Measured on-axis in free space (4π space) at 2 metres, then referred to 1 metre
- (2) Measured in free space at 1 metre with a tone burst signal
- (3) Measured on-axis on ground plane (2π space) at 2 metres, then referred to 1 metre
- (4) Measured in half-space at 1 metre with a tone burst signal

Technical Drawings

CDD-Live 8

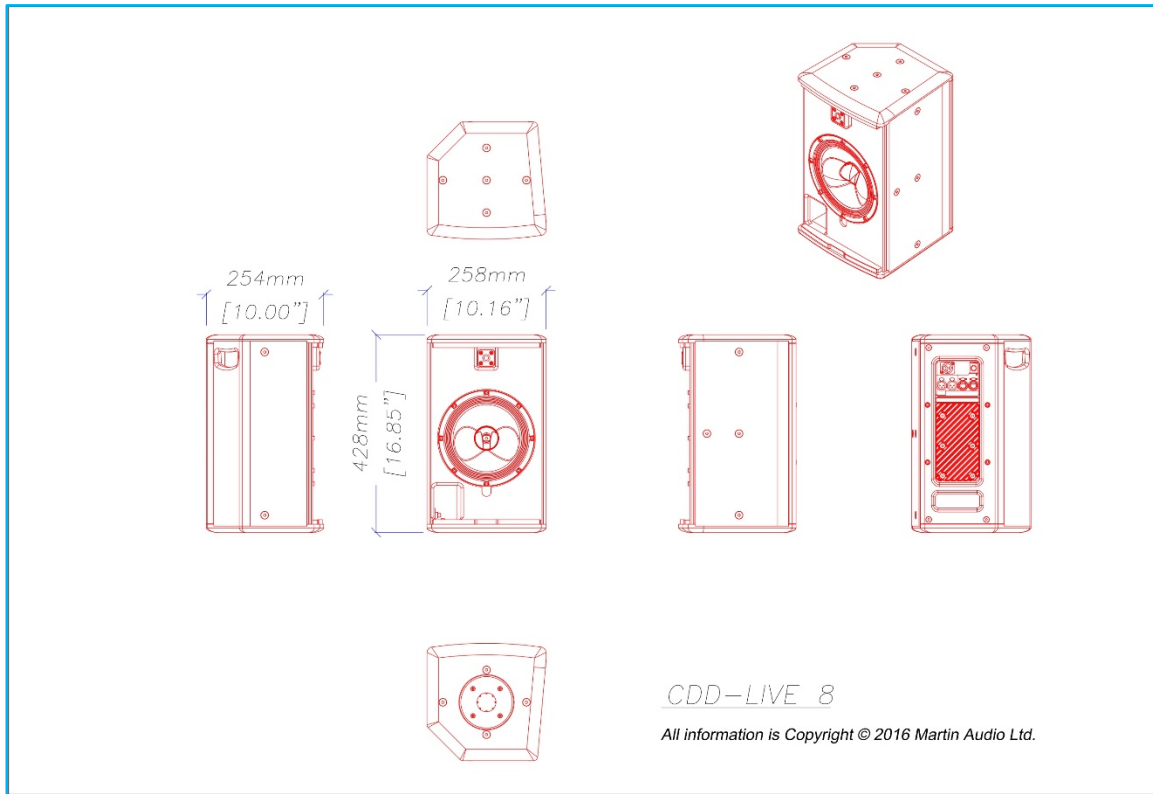

CDD-Live 12

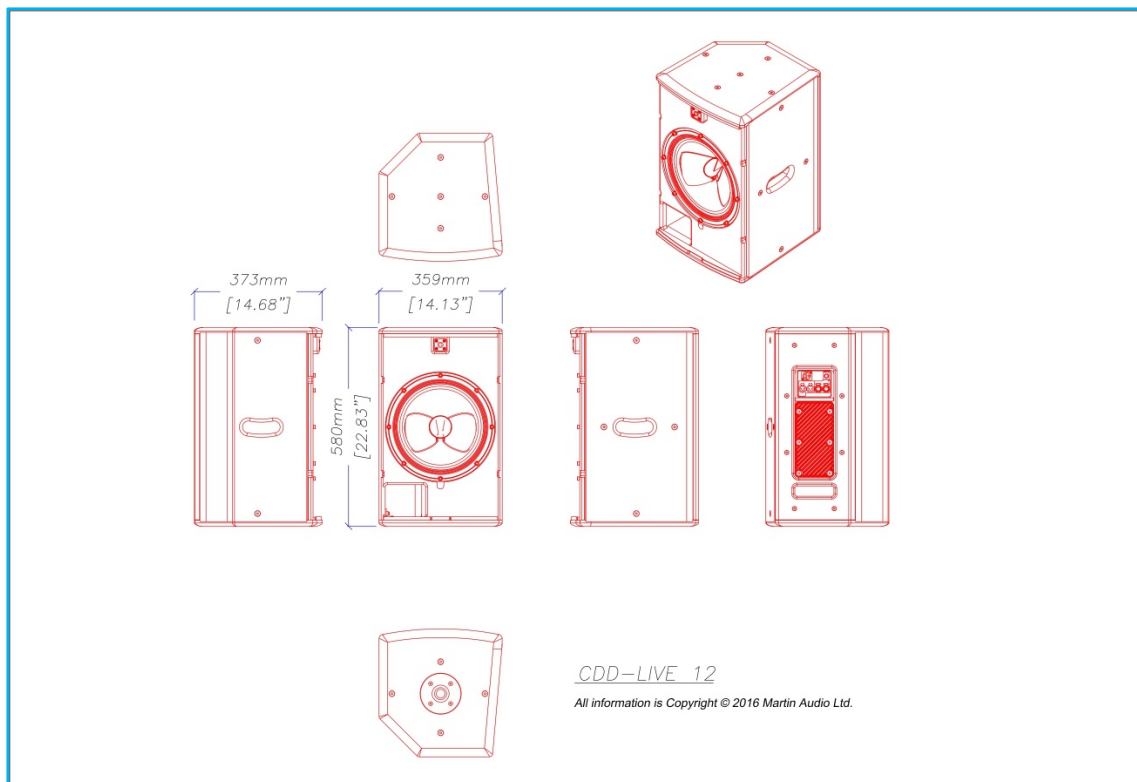

CDD-Live 15

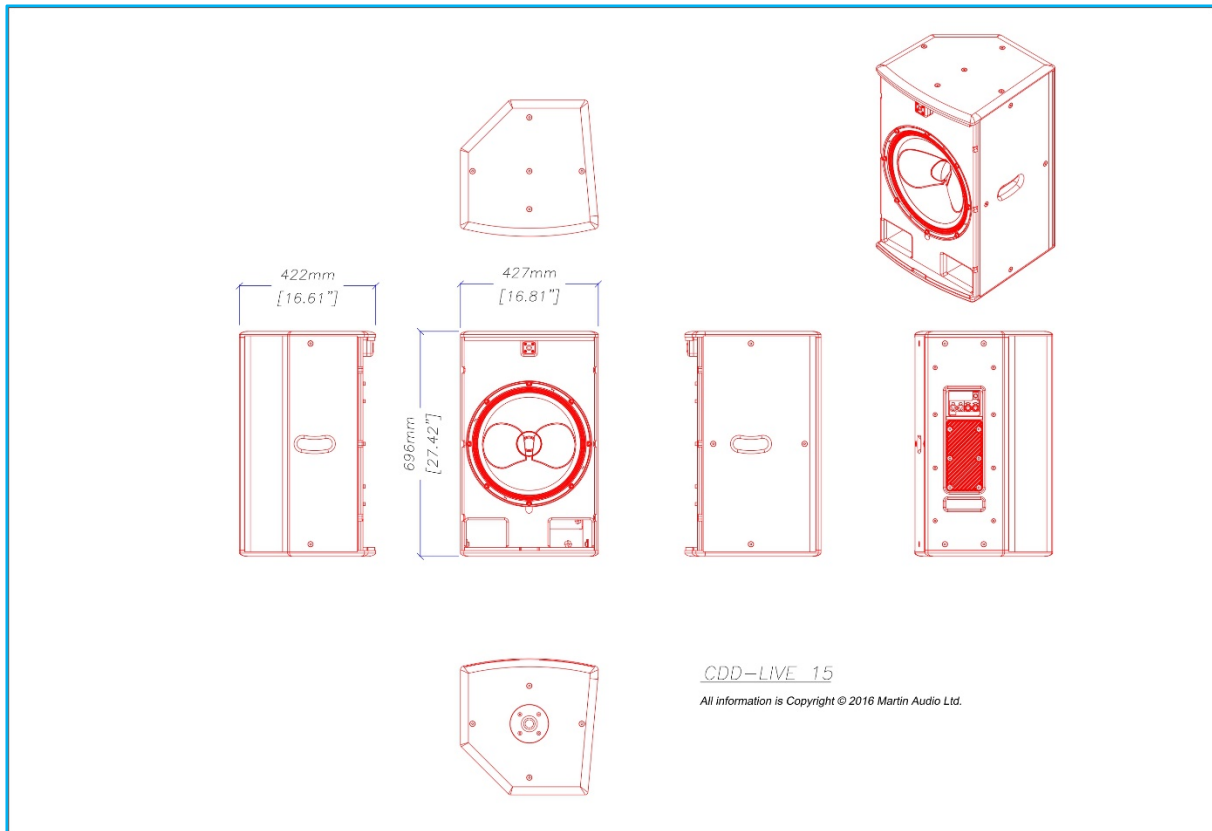

SXP118

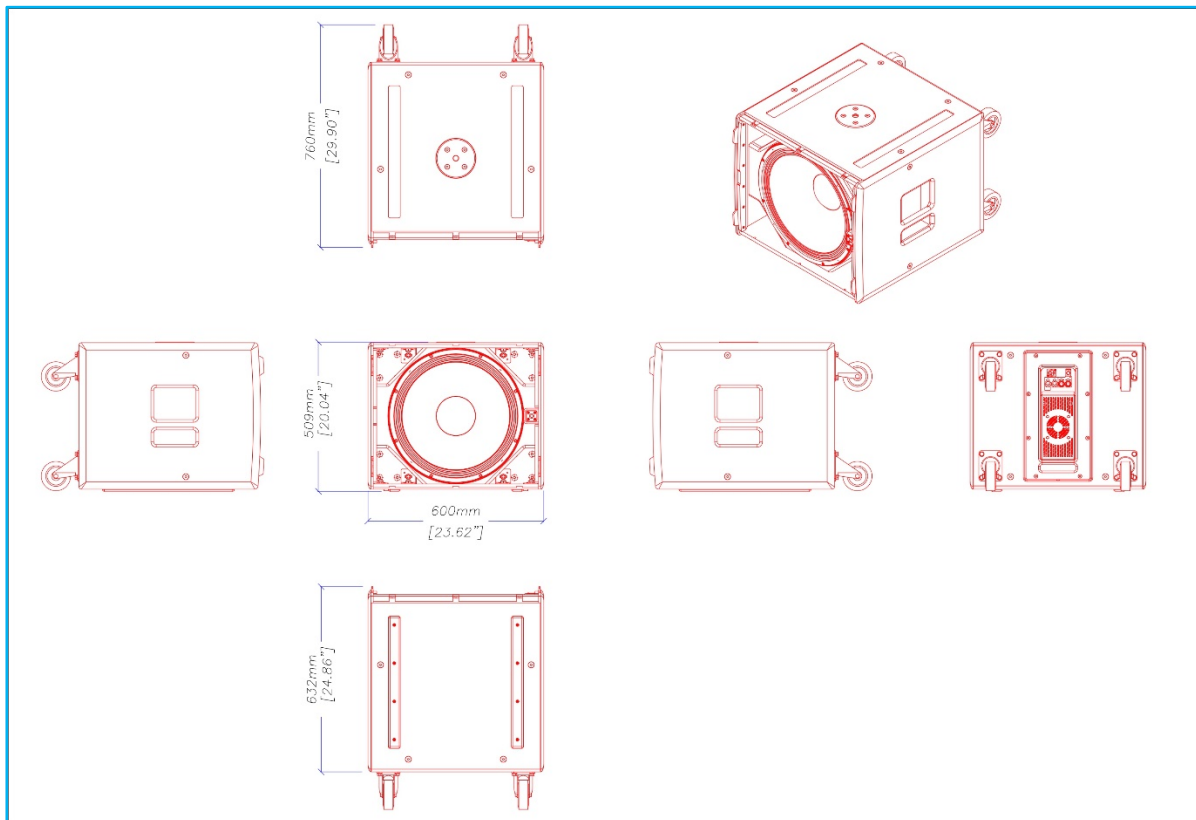

SXP218

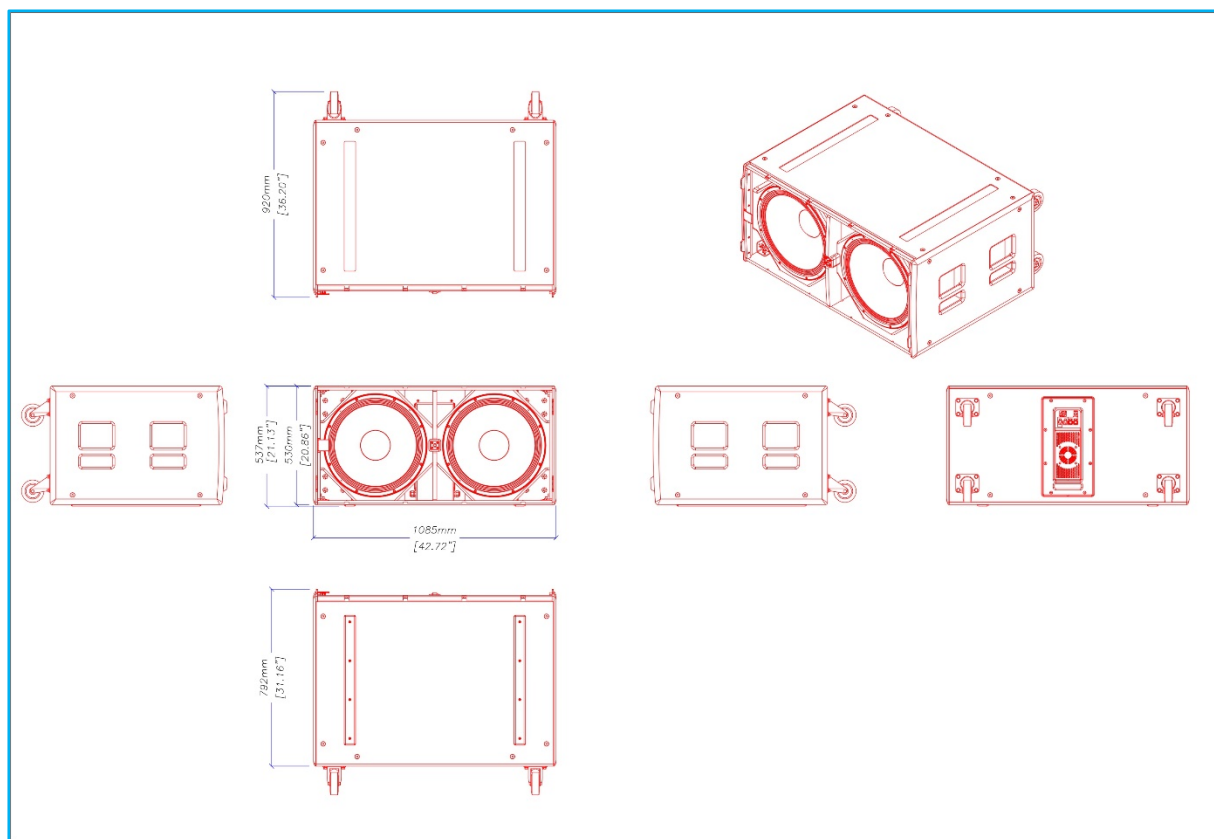



Warranty

Martin Audio CDD-Live and SXP Loudspeaker Systems are warranted against manufacturing defects in materials or craftsmanship over a period of 5 years from the date of original purchase.

Martin Audio CDD-Live and SXP Amplifier modules are warranted against manufacturing defects in materials or craftsmanship over a period of 1 year from the date of original purchase.

During the warranty period Martin Audio will, at its discretion, either repair or replace products which prove to be defective provided that the product is returned in its original packaging, shipping prepaid, to an authorised Martin Audio service agent or distributor.

Martin Audio Ltd. cannot be held responsible for defects caused by unauthorised modifications, improper use, negligence, exposure to inclement weather conditions, act of God or accident, or any use of this product that is not in accordance with the instructions provided by Martin Audio.

Martin Audio is not liable for consequential damages.

This warranty is exclusive and no other warranty is expressed or implied. This warranty does not affect your statutory rights.



Martin Audio Limited
Century Point
Halifax Road
Cressex Business Park
High Wycombe
Buckinghamshire
HP12 3SL
England

UK
Telephone: +44 (0)1494 535312
Facsimile: +44 (0)1494 438669
E-mail: infona@martin-audio.com

NORTH AMERICA
Telephone: 519 747 5853
Facsimile: 519 747 3576
E-mail: info@martin-audio.com

All information is Copyright © 2016 Martin Audio Ltd.

Martin Audio, the Martin Audio logo and CDD-Live are registered trademarks of Martin Audio Ltd. in the United Kingdom, United States and other countries; all other Martin Audio trademarks are the property of Martin Audio Ltd.

All other trademarks and trade names are the property of their respective owners.

www.martin-audio.com
